

TRES



2023

Designed and produced in Barcelona

CARACTERÍSTICAS



Novedad



Desagüe automático incluido



Válvula Simple-Rapid incluida



Barra de ducha telescópica



Indicado para personas con discapacidades físicas



Funciona con alimentación eléctrica



Funciona con alimentación a pilas



Rociador de latón



Rociador de acero inoxidable



Rociador de ABS



Ducha de mano de latón



Ducha de mano de acero inoxidable



Ducha de mano de ABS

RECAMBIOS



Cartucho (referencia del recambio)



Montura (referencia del recambio)



Distribuidor (referencia del recambio)



Volante + cartucho (referencia del recambio)

INDICACIONES



Ángulo de giro del caño



13,5-16,5

Excentricidad especial



Funciones del rociador (litros/minuto)



Funciones de la ducha de mano (litros/minuto)



Funciones de los jets (litros/minuto)



Tiempo de apertura (en segundos)



Frío (indicador del volante)



Caliente (indicador del volante)

TECNOLOGÍA



Ducha con sistema de Cromoterapia



Cartucho Tres Therm 77®



Cartucho Tres Instant 77®



Cartucho Tres Instant 57®



Touch-Cool®: La superficie del grifo siempre está fría



Easy-Clean®: Fácil acceso y mantenimiento del cartucho



Cold-Tres®: El grifo siempre se abre con agua fría



Tres-Duo®: En la posición intermedia se consume la mitad

TRÉS

2023

Los productos mostrados en este catálogo pueden sufrir leves modificaciones por exigencias de diseño, siempre en beneficio del artículo.

Los precios de este catálogo son recomendados de venta al público y no incluyen el IVA.

Ante posibles errores de impresión, los precios revisados y definitivos aparecen siempre en la web de Tres.

Para conocer la disponibilidad de los productos, consulte la página web.

A través de la página web puede estar al día de las novedades de Tres o consultar si un producto ha sido descatalogado.

CONTENIDO

010 COLECCIONES

Exclusive

- 014 **N** Mont Blanc
- 020 Tres Clasic
- 040 Slim
- 054 Study
- 072 Cuadro

Selection

- 092 Loft
- 106 **N** Fuji
- 116 Project-tres
- 130 Max
- 146 Lex-Alp
- 160 Class

Essential

- 170 Flat
- 180 Canigó Plus
- 192 Canigó
- 202 Base Plus
- 212 Base
- 220 Ese-23

226 ESPACIO DE DUCHA

Electrónicos

- 228 Shower technology

Termostáticos

- 242 **N** Empotrados B-system
- 252 **N** Empotrados Therm-box
- 272 **N** Murales Over-wall

Monomandos

- 290 Empotrados 3V
- 298 **N** Empotrados Rapid-box
- 322 Empotrados
- 336 Murales
- 346 Borde de bañera

354 COMPLEMENTOS DE DUCHA

- 362 Rociadores
- 381 Duchas de mano
- 387 Flexos
- 390 Barras deslizantes
- 399 Kits de ducha
- 404 Soportes y tomas de pared
- 407 Codo adaptador a pared
- 408 Jets

412 ACCESORIOS DE BAÑO

- 414 Cuadrado
- 415 Redondo
- 416 Clásico

418 TECNOLOGÍA ELECTRÓNICA

- 420 Shower Technology
- 429 Lavabos
- 435 Dispensadores de jabón
- 436 Sensores WC
- 437 Cocina electrónica

438 ESPACIO DE COCINA

- 444 Monomandos
- 454 A muro
- 457 Con caño flexible
- 458 Para tratamiento de agua
- 460 Con caño extraíble
- 462 Con caño abatible
- 462 Bimandos
- 466 Industriales
- 468 Electrónicos
- 469 Grifos para varios usos

470 COLECTIVIDADES

- 472 Grifos temporizados
- 477 Grifos medicales
- 478 Grifos para peluquería
- 479 Grifos para exterior

482 COMPLEMENTOS DE GRIFERÍA

- 484 Válvulas y desagües
- 494 Sifones
- 497 Llaves de paso
- 499 Connexiones acodadas y alargaderas
- 501 Caños
- 504 Florones
- 505 Excéntricas
- 506 Válvulas de vaciado
- 508 WC Systems
 - 510 Mecanismos de llenado
 - 511 Mecanismos de descarga
- 514 Tres Cleaner
 - 516 Limpiador de grifería

518 ANEXO

- 520 Instalación recomendada
- 523 Nuevos diseños de volantes
- 524 Recambios
- 528 Listado de referencias
- 540 Condiciones de venta



Toda invención tiene su origen

Tres inició su actividad en 1968 en la zona vinícola del Penedès (España).

La incursión por parte de la empresa en el sector de la grifería empezó cuando su fundador, Jaume Tres, revolucionó el sector del vino con un nuevo grifo para barricas que mejoraba el cierre hermético.

Este nuevo grifo evitaba pérdidas de vino y entradas de aire innecesarias eliminando la espuma al salir.

A partir de la creación de grifos para barricas de vino surge el espíritu industrial de Tres y una larga trayectoria de invención y diseño para crear las mejores experiencias para baño y cocina.





Fundada el 1968, Tres es una empresa familiar dedicada al diseño, fabricación y comercialización de grifos para baño y cocina y otras soluciones para el uso del agua.

Con presencia a nivel global, desde la factoría central situada en Vallirana (Barcelona) se producen más de 3000 modelos distintos de grifería con el objetivo de dar respuesta a las necesidades de los usuarios fabricando productos accesibles a todos donde el diseño y la experiencia de uso ayuden a hacer más agradable el consumo responsable del agua.





Espíritu industrial

Para garantizar la máxima calidad en sus productos, Tres controla todo el proceso de fabricación en sus instalaciones, desde que se concibe la idea, hasta que se hace realidad. El espíritu de Tres queda patente en cada grifo cuidando su diseño y mejorando la tecnología, para ofrecer un producto único, actual y funcional, con gran variedad de soluciones para todas aquellas personas que buscan confort.



1 Diseño



2 Ingeniería



3 Laboratorio



4 Fundición



5 Mecanizado



6 Pulido



7 Acabado



8 Montaje

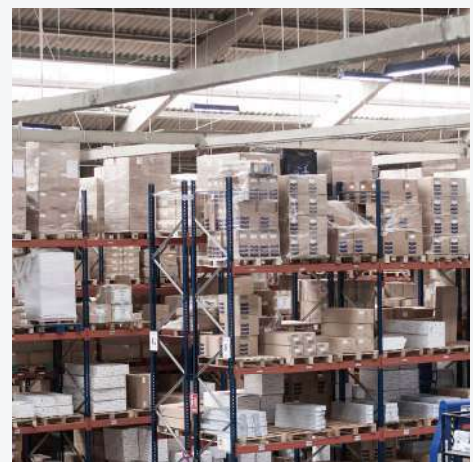

9 Expedición

COLD-TRES® AHORRO DE ENERGÍA



Sistema de bajo consumo energético en el que el grifo se abre siempre con agua fría, evitando el encendido innecesario del calentador.

Al abrir la maneta en posición central, sólo se consume agua fría y es el consumidor quien decide cuando quiere utilizar agua caliente desplazando la maneta hacia la izquierda, lo que supone un bajo consumo de energía.

Ideado y patentado por Tres desde 1992.

TRES-DUO® AHORRO DE AGUA



Sistema de bajo consumo de agua con una apertura de la maneta en dos posiciones. En la posición intermedia se consume el 50% del agua.

El 90% de las veces que utilizamos un grifo en el lavabo o en la cocina no tenemos la necesidad de utilizar el caudal máximo. Con este sistema obtenemos un menor consumo de agua y energía.

Ideado y patentado por Tres desde 2010.

TRES TOUCH-COOL®

SISTEMA DE SEGURIDAD ANTIQUEMADURAS

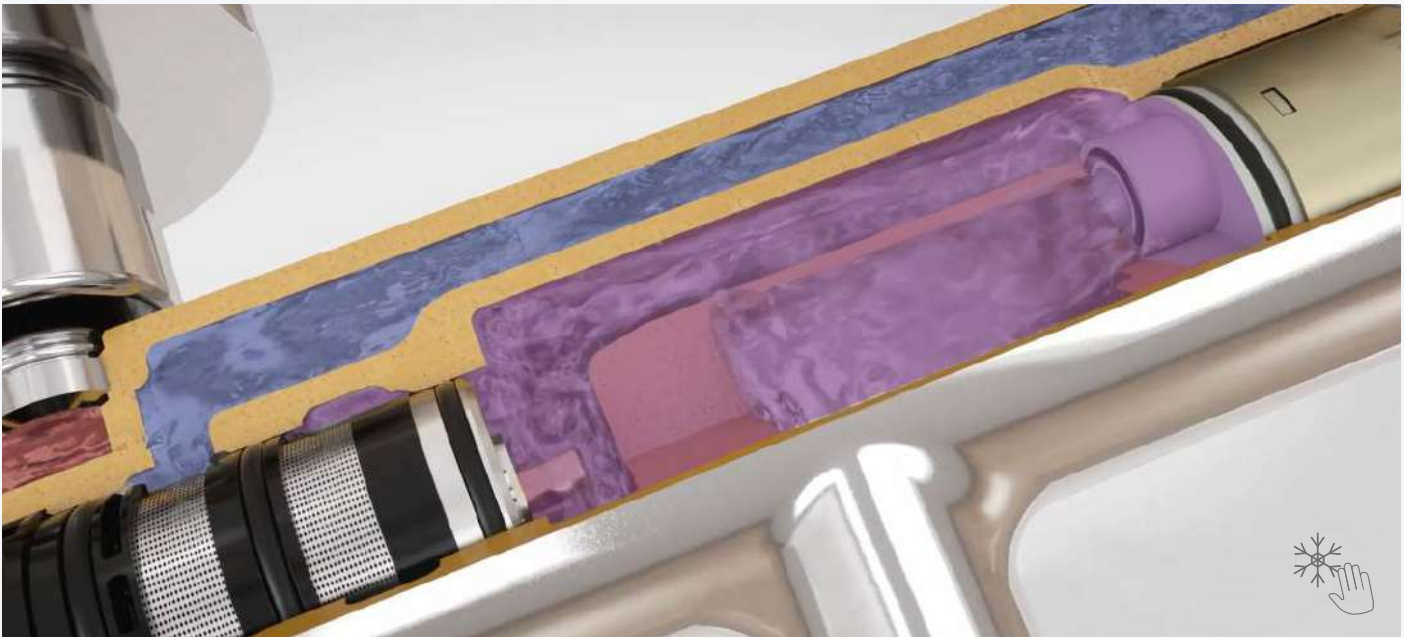

Tres Touch-cool® es un sistema que consigue mantener la superficie del grifo a una temperatura apta para el tacto, evitando quemaduras.

Es un sistema de seguridad especialmente interesante cuando los usuarios son niños o personas mayores, ya que son estos los que tienen un riesgo más elevado de tocar el grifo.



CR Cromado

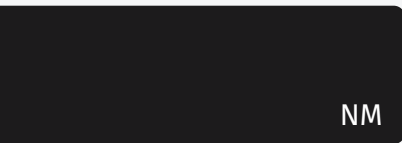

NM Negro mate



BM Blanco mate



AC Acero



KM Negro metalizado



KMB Negro bronce



OR Oro 24k



OM Oro mate 24k



OP Oro Rosa 24k



N OPM Oro Rosa mate 24k



LV Latón viejo



LM Latón viejo mate









	Mont Blanc	Tres Classic	Slim	Study	Cuadro	Loft	Fuji	Project-tres	Max	Lex/Alp	CLASS	Flat	Canigó Plus	Canigó	Base Plus	Base	Ese-23	Shower technology	B-system	Therm-box	Over-wall	Rapid-box	Accesorios	Cocina
	14	20	40	54	72	92	106	116	130	146	160	170	180	192	202	212	220	228	242	252	272	298	412	438
CR	✓	✓	✓	✓	✓	✓	✓	✓	✓	✓	✓	✓	✓	✓	✓	✓	✓	✓	✓	✓	✓	✓	✓	✓
NM	✓		✓	✓	✓	✓	✓	✓							✓			✓	✓	✓	✓	✓	✓	✓
BM			✓	✓	✓	✓		✓												✓	✓	✓	✓	✓
AC	✓	✓	✓	✓	✓	✓	✓	✓											✓	✓	✓	✓	✓	✓
KM				✓				✓												✓		✓	✓	
KMB				✓				✓												✓	✓	✓	✓	
OR		✓	✓	✓	✓	✓		✓											✓	✓		✓	✓	✓
OM	✓		✓	✓	✓	✓		✓										✓	✓	✓	✓	✓	✓	✓
OP				✓				✓											✓	✓		✓	✓	
OPM	✓			✓				✓										✓	✓	✓	✓	✓	✓	
LV		✓																					✓	✓
LM		✓																					✓	✓
TAM				✓																				
TRO				✓																				
NE					✓	✓																		
BL					✓	✓																		

COLECCIONES

















EXCLUSIVE

	Mont Blanc	014
	Tres Clasic	020
	Slim	040
	Study	054
	Cuadro	072

SELECTION

	Loft	092
	Fuji	106
	Project-tres	116
	Max	130
	Lex-Alp	146
	Class	160

ESSENTIAL

	Flat	170
	Canigó Plus	180
	Canigó	192
	Base Plus	202
	Base	212
	Ese-23	220



MONT BLANC

La colección Mont Blanc de Tres parte de una arquitectura simétrica construida bajo las premisas del diseño, la funcionalidad y el cuidado de todos los detalles. Con los característicos volantes en forma de cruz, esta revisión de la estética clásica permite más adaptabilidad y convierte sus piezas en algo atemporal y genuino.

Acabados disponibles:



CR



NM



AC



OM



OPM





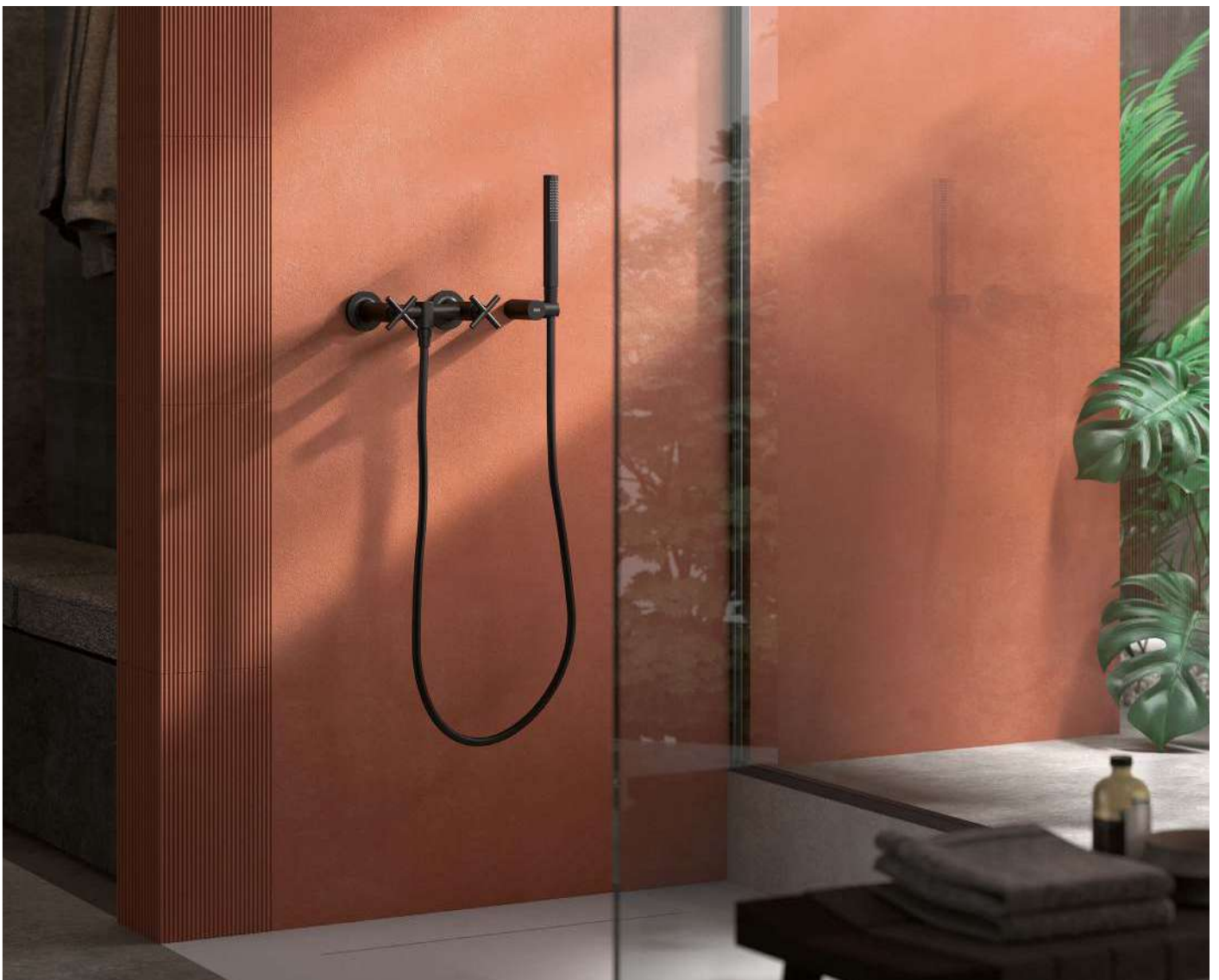





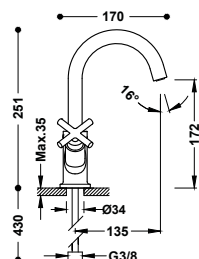



GRIFOS PARA LAVABO



Grifo bimando para lavabo

Con volantes. Latiguillos de alimentación flexibles G3/8.

-  28310301 **225,00**
-  28310301NM **349,00**
-  28310301AC **349,00**
-  28310301OM **450,00**
-  28310301OPM **450,00**



29916402 29916403

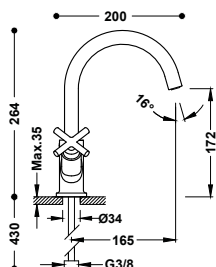

Grifo bimando alto para lavabo

Con volantes. Latiguillos de alimentación flexibles G3/8.

-  28320301 **240,00**
-  28320301NM **372,00**
-  28320301AC **372,00**
-  28320301OM **480,00**
-  28320301OPM **480,00**



29916402 29916403

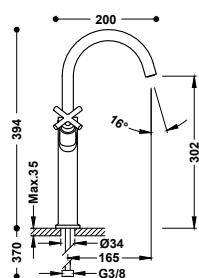

Grifo bimando XXL para lavabo

Con volantes. Latiguillos de alimentación flexibles G3/8.

-  28380301 **280,00**
-  28380301NM **434,00**
-  28380301AC **434,00**
-  28380301OM **560,00**
-  28380301OPM **560,00**



29916402 29916403

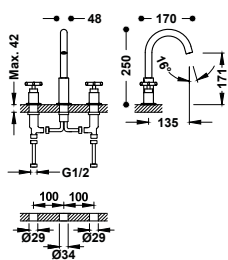

Grifo bimando de repisa para lavabo

De instalación libre. Con volantes.

-  28310501 **300,00**
-  28310501NM **465,00**
-  28310501AC **465,00**
-  28310501OM **600,00**
-  28310501OPM **600,00**

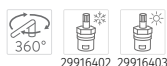



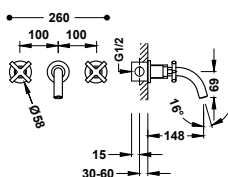

29916402 29916403



Grifo bimando empotrado para lavabo

Cuerpo empotrado incluido e indivisible. Con volantes. Caño de 148 mm.

-  28330001 **275,00**
-  28330001NM **426,00**
-  28330001AC **426,00**
-  28330001OM **550,00**
-  28330001OPM **550,00**



29916402 29916403

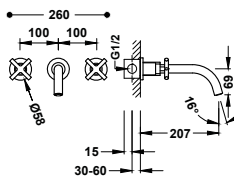

Grifo bimando empotrado para lavabo

Cuerpo empotrado incluido e indivisible. Con volantes. Caño de 207 mm.

28330002 **285,00**

28330002NM **442,00**

28330002AC **442,00**

28330002OM **570,00**

28330002OPM **570,00**



GRIFOS PARA BIDÉ

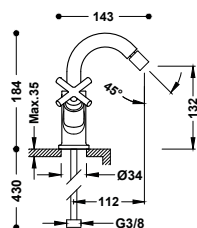

Grifo bimando para bidé

Rótula orientable. Con volantes. Latiguillos de alimentación flexibles G3/8.

28312001 **228,00**

28312001NM **353,00**

28312001AC **353,00**

28312001OM **456,00**

28312001OPM **456,00**

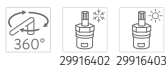

GRIFOS MURALES

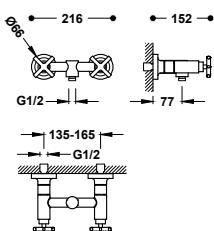

Grifo bimando mural para ducha

Ducha de mano anticalcárea de latón. Soporte orientable para ducha de mano. Flexo satinado.

28316301 **320,00**

28316301NM **496,00**

28316301AC **496,00**

28316301OM **640,00**

28316301OPM **640,00**

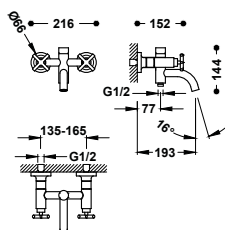
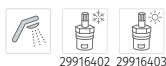

Grifo bimando mural para bañera y ducha

Ducha de mano anticalcárea de latón. Soporte orientable para ducha de mano. Flexo satinado.

28317601 **385,00**

28317601NM **597,00**

28317601AC **597,00**

28317601OM **770,00**

28317601OPM **770,00**







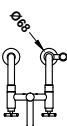
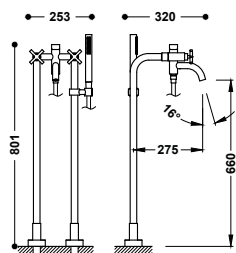

GRIFOS PARA BAÑERA



Grifo bimando de suelo para bañera y ducha

Con 2 columnas verticales de alimentación de agua a suelo. Ducha de mano anticalcárea de latón. Soporte fijo para ducha de mano. Flexo satinado.

-  28319401 **550,00**
-  28319401NM **853,00**
-  28319401AC **853,00**
-  28319401OM **1.100,00**
-  28319401OPM **1.100,00**

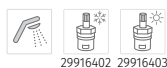

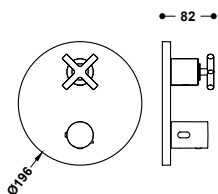

GRIFO TERMOSTÁTICO EMPOTRADO THERM-BOX



Pieza vista para caja empotrada de 2 vías Therm-box

Sólo parte vista. Volante en cruz. Incluye placa embellecedora, mando y volante distribuidor. Completar con la caja empotrada Therm-box ref.: 20785001.

-  28325001 **170,00**
-  28325001NM **264,00**
-  28325001AC **264,00**
-  28325001OM **340,00**
-  28325001OPM **340,00**



Caja empotrada de 2 vías Therm-box con grifo termostático para ducha y bañera

- 20785001 **130,00 N**

TRES CLASIC

Su diseño se inspira en la grifería clásica pero con la tecnología actual. Con la colección Clasic de Tres se consigue el ambiente rústico, clásico y elegante que buscas. Los acabados especiales que presenta son perfectos para completar un baño inspirador.

Acabados disponibles:



CR



AC



OR



LV



LM









GRIFOS PARA LAVABO

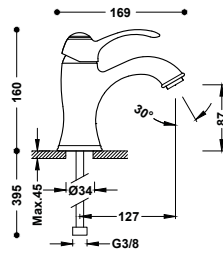

Grifo monomando para lavabo

Latiguillos de alimentación flexibles G3/8.



9134592

- 24210301 **205,00**
- 24210301AC **318,00**
- 24210301OR **410,00**
- 24210301LV **287,00**
- 24210301LM **287,00**

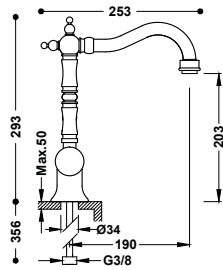

Grifo monomando con maneta lateral para lavabo

Latiguillos de alimentación flexibles G3/8.



9134591

- 24210801 **240,00**
- 24210801AC **372,00**
- 24210801OR **480,00**
- 24210801LV **336,00**
- 24210801LM **336,00**

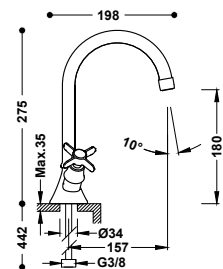

Grifo bimando para lavabo

Con volantes. Latiguillos de alimentación flexibles G3/8.



9134282

- 24210901 **170,00**
- 24210901AC **264,00**
- 24210901OR **340,00**
- 24210901LV **238,00**
- 24210901LM **238,00**

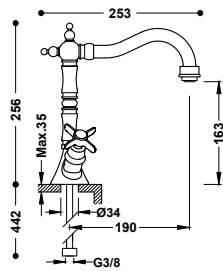

Grifo bimando para lavabo

Con volantes. Latiguillos de alimentación flexibles G3/8.



9134282

- 24210902 **265,00**
- 24210902AC **411,00**
- 24210902OR **530,00**
- 24210902LV **371,00**
- 24210902LM **371,00**

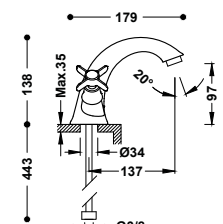

Grifo bimando para lavabo

Con volantes. Latiguillos de alimentación flexibles G3/8.



9134282

- 24210201 **260,00**
- 24210201AC **403,00**
- 24210201OR **520,00**
- 24210201LV **364,00**
- 24210201LM **364,00**

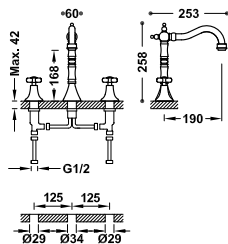

Grifo bimando de repisa para lavabo
De instalación libre. Con volantes.

- 24210501 **365,00**
- 24210501AC **566,00**
- 24210501OR **730,00**
- 24210501LV **511,00**
- 24210501LM **511,00**

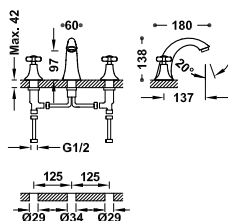

Grifo bimando de repisa para lavabo
De instalación libre. Con volantes.

- 24210601 **310,00**
- 24210601AC **481,00**
- 24210601OR **620,00**
- 24210601LV **434,00**
- 24210601LM **434,00**

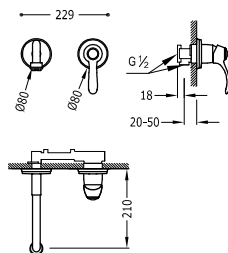

Grifo monomando empotrado para lavabo
Cuerpo empotrado incluido e indivisible. Caño de 210 mm.

- 24220001 **250,00**
- 24220001AC **388,00**
- 24220001OR **500,00**
- 24220001LV **350,00**
- 24220001LM **350,00**

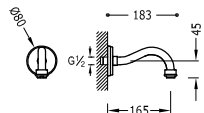

Caño fijo de pared
Long: 165 mm.

- 24217302 **97,00**
- 24217302AC **150,00**
- 24217302OR **194,00**
- 24217302LV **136,00**
- 24217302LM **136,00**

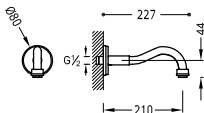

Caño fijo de pared
Long: 210 mm.

- 24217301 **105,00**
- 24217301AC **163,00**
- 24217301OR **210,00**
- 24217301LV **147,00**
- 24217301LM **147,00**

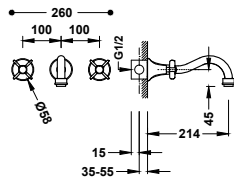

Grifo bimando empotrado para lavabo

Cuerpo empotrado incluido e indivisible. Con volantes. Caño de 214 mm.



- 24215101 **270,00**
- 24215101AC **419,00**
- 24215101OR **540,00**
- 24215101LV **378,00**
- 24215101LM **378,00**

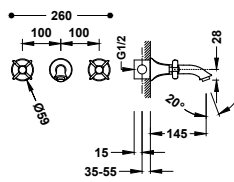

Grifo bimando empotrado para lavabo

Cuerpo empotrado incluido e indivisible. Con volantes. Caño de 145 mm.



- 24215102 **290,00**
- 24215102AC **450,00**
- 24215102OR **580,00**
- 24215102LV **406,00**
- 24215102LM **406,00**

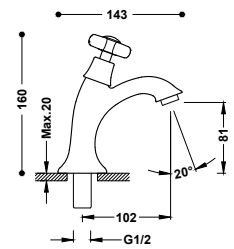

Grifo de 1 agua para lavabo

Con conexión roscada de G1/2.



- 24250301 **96,00**
- 24250301AC **149,00**
- 24250301OR **192,00**
- 24250301LV **134,00**
- 24250301LM **134,00**

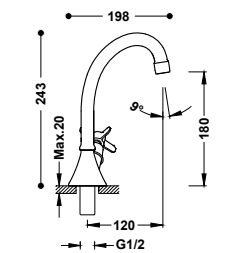

Grifo de 1 agua con volante lateral para lavabo

Con conexión roscada de G1/2.



- 24230601 **98,00**
- 24230601AC **152,00**
- 24230601OR **196,00**
- 24230601LV **137,00**
- 24230601LM **137,00**

GRIFOS PARA BIDÉ

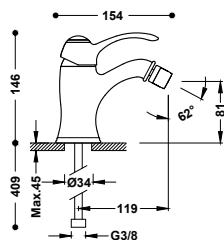

Grifo monomando para bidé

Rótula orientable. Latiguillos de alimentación flexibles G3/8.



9134592

- 24212001 **215,00**
- 24212001AC **333,00**
- 24212001OR **430,00**
- 24212001LV **301,00**
- 24212001LM **301,00**

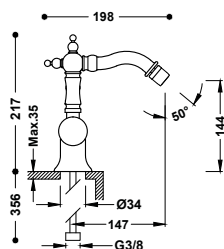

Grifo monomando con maneta lateral para bidé

Rótula orientable. Latiguillos de alimentación flexibles G3/8.



9134591

- 24222001 **243,00**
- 24222001AC **377,00**
- 24222001OR **486,00**
- 24222001LV **340,00**
- 24222001LM **340,00**

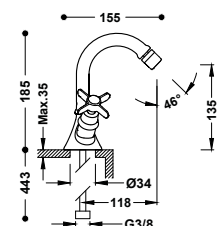

Grifo bimando para bidé

Rótula orientable. Con volantes. Latiguillos de alimentación flexibles G3/8.



9134282

- 24212201 **177,00**
- 24212201AC **274,00**
- 24212201OR **354,00**
- 24212201LV **248,00**
- 24212201LM **248,00**

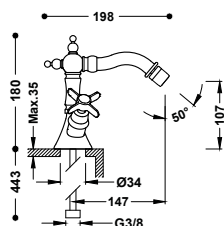

Grifo bimando para bidé

Rótula orientable. Con volantes. Latiguillos de alimentación flexibles G3/8.



9134282

- 24212202 **275,00**
- 24212202AC **426,00**
- 24212202OR **550,00**
- 24212202LV **385,00**
- 24212202LM **385,00**

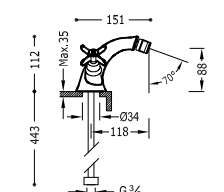

Grifo bimando para bidé

Rótula orientable. Con volantes. Latiguillos de alimentación flexibles G3/8.



9134282

- 24212101 **270,00**
- 24212101AC **419,00**
- 24212101OR **540,00**
- 24212101LV **378,00**
- 24212101LM **378,00**



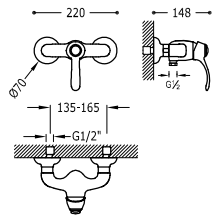

GRIFOS MURALES



Grifo monomando mural para ducha

Ducha de mano anticalcárea de latón: Ø 78 mm. Soporte orientable para ducha de mano. Flexo metálico reforzado.

	24216701	290,00
	24216701AC	450,00
	24216701OR	580,00
	24216701LV	406,00
	24216701LM	406,00

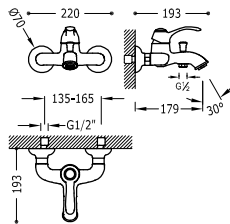

Grifo monomando mural para bañera y ducha

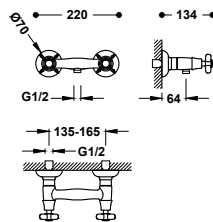

Ducha de mano anticalcárea de latón: Ø 78 mm. Soporte orientable para ducha de mano. Flexo metálico reforzado.

	24217001	335,00
	24217001AC	519,00
	24217001OR	670,00
	24217001LV	469,00
	24217001LM	469,00



Grifo bimando mural para ducha



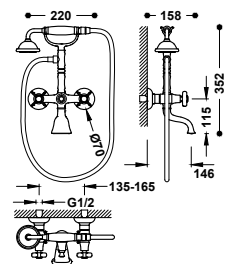

Ducha de mano anticalcárea de latón: Ø 78 mm. Soporte orientable para ducha de mano. Flexo metálico reforzado.

	24216301	280,00
	24216301AC	434,00
	24216301OR	560,00
	24216301LV	392,00
	24216301LM	392,00



Grifo bimando mural para bañera y ducha

Ducha de mano anticalcárea de latón: Ø 78 mm. Soporte fijo para ducha de mano. Flexo metálico reforzado.



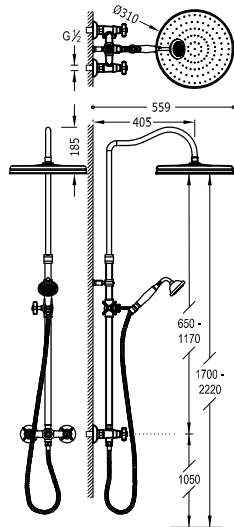

	24217601	415,00
	24217601AC	643,00
	24217601OR	830,00
	24217601LV	581,00
	24217601LM	581,00





Conjunto de grifo bimando mural de 2 vías para ducha



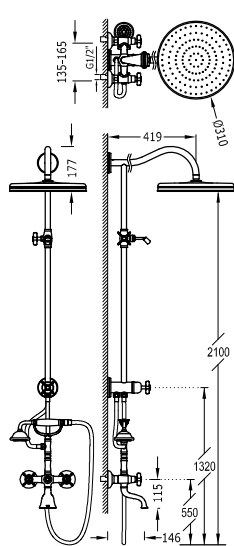

- Barra de ducha telescópica.
- Rociador de ducha orientable de latón: Ø 310 mm.
- Soporte deslizante y orientable para ducha de mano.
- Ducha de mano anticalcárea de latón: Ø 78 mm.
- Flexo metálico reforzado.

	24219101	995,00
	24219101AC	1.542,00
	24219101LV	1.393,00
	24219101LM	1.393,00



Conjunto de grifo bimando mural de 2 vías para bañera y ducha

- Con inversor integrado en la barra de ducha.
- Rociador de ducha orientable de latón: Ø 310 mm.
- Soporte deslizante y orientable para ducha de mano.
- Ducha de mano anticalcárea de latón: Ø 78 mm.
- Flexo metálico reforzado.

	24217602	849,00
	24217602AC	1.316,00
	24217602LV	1.189,00
	24217602LM	1.189,00





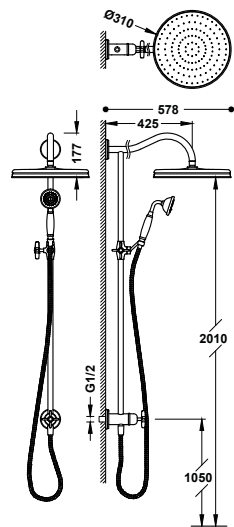

COMPLEMENTOS DE DUCHA



Conjunto de barra de ducha sin grifo con toma de agua a pared y rociador

- Con inversor integrado en la barra de ducha.
- Rociador de ducha orientable de latón: Ø 310 mm.
- Soporte deslizante y orientable para ducha de mano.
- Ducha de mano anticalcárea de latón: Ø 78 mm.
- Flexo metálico reforzado.



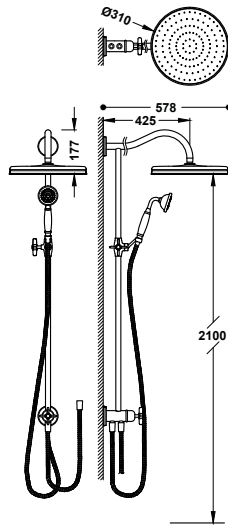

	24247602	458,00
	24247602AC	710,00
	24247602LV	641,00
	24247602LM	641,00





Conjunto de barra de ducha adaptable a cualquier grifo



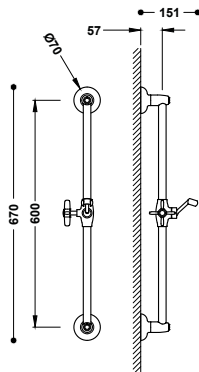

- Con inversor integrado en la barra de ducha.
- Rociador de ducha orientable de latón: Ø 310 mm.
- Soporte deslizante y orientable para ducha de mano.
- Ducha de mano anticálcarea de latón: Ø 78 mm.
- Flexo metálico reforzado.

	24247601	470,00
	24247601AC	729,00
	24247601LV	658,00
	24247601LM	658,00



Barra deslizante para ducha



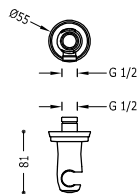

Barra de ducha: long. 600 mm y Ø 20,6 mm. Soporte deslizante y orientable para ducha de mano.

	24273201	210,00
	24273201AC	326,00
	24273201LV	294,00
	24273201LM	294,00



Soporte fijo con toma de agua para ducha de mano y flexo



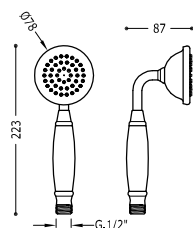

Con toma de agua a pared.

	24218201	68,00
	24218201AC	105,00
	24218201OR	136,00
	24218201LV	95,20
	24218201LM	95,20



Ducha de mano

Mango cerámico. Dimensiones: Ø 78 mm. Material: Latón. Boquillas anticálcarea.

	29963109	56,00
	29963109AC	86,80
	29963109OR	112,00
	29963109LV	78,40
	29963109LM	78,40

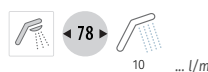

GRIFOS EMPOTRADOS

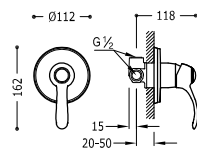

Grifo monomando empotrado de 1 vía para ducha
Cuerpo empotrado incluido.

- 24217701 **110,00**
- 24217701AC **171,00**
- 24217701OR **220,00**
- 24217701LV **154,00**
- 24217701LM **154,00**

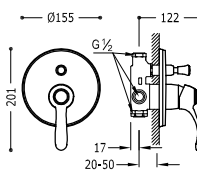

Grifo monomando empotrado de 2 vías para bañera y ducha
Cuerpo empotrado incluido. Inversor de 2 vías.

- 24218001 **170,00**
- 24218001AC **264,00**
- 24218001OR **340,00**
- 24218001LV **238,00**
- 24218001LM **238,00**

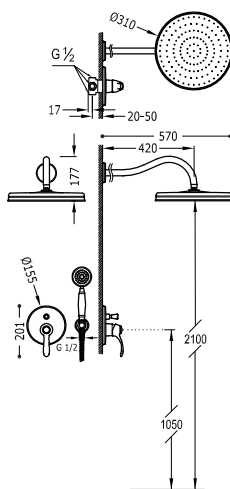

Kit de grifo monomando empotrado de 2 vías para ducha

- Cuerpo empotrado incluido.
- Inversor de 2 vías.
- Brazo a pared con rociador de ducha orientable y de latón: Ø 310 mm.
- Soporte para ducha de mano con toma de agua a pared.
- Ducha de mano anticalcárea de latón: Ø 78 mm.
- Flexo metálico reforzado.

- 24218003 **654,00**
- 24218003AC **1.014,00**
- 24218003OR **1.308,00**
- 24218003LV **916,00**
- 24218003LM **916,00**

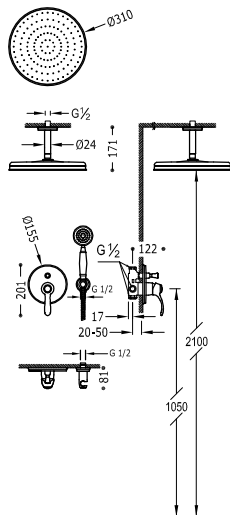

Kit de grifo monomando empotrado de 2 vías para ducha

- Cuerpo empotrado incluido.
- Inversor de 2 vías.
- Brazo a techo con rociador de ducha orientable y de latón: Ø 310 mm.
- Soporte para ducha de mano con toma de agua a pared.
- Ducha de mano anticalcárea de latón: Ø 78 mm.
- Flexo metálico reforzado.



- 24218004 **621,00**
- 24218004AC **963,00**
- 24218004OR **1.242,00**
- 24218004LV **869,00**
- 24218004LM **869,00**

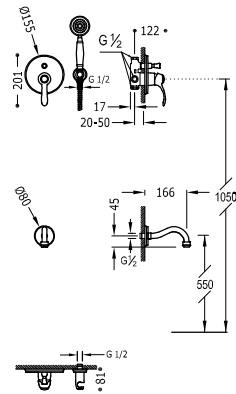



Kit de grifo monomando empotrado de 2 vías para ducha



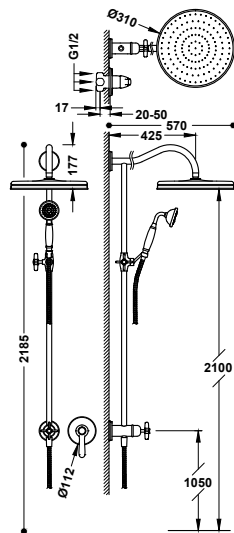

- Cuerpo empotrado incluido.
- Inversor de 2 vías.
- Caño fijo de bañera a pared.
- Soporte para ducha de mano con toma de agua a pared.
- Ducha de mano anticalcárea de latón: Ø 78 mm.
- Flexo metálico reforzado.

	24218005	409,00
	24218005AC	634,00
	24218005OR	818,00
	24218005LV	573,00
	24218005LM	573,00



Kit de grifo monomando empotrado de 1 vía para ducha



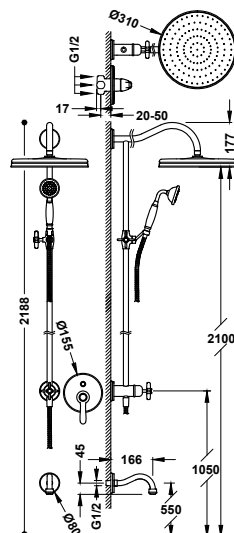

- Cuerpo empotrado incluido.
- Conjunto de barra de ducha con rociador de ducha orientable de latón: Ø 310 mm.
- Inversor integrado en la barra de ducha.
- Soporte deslizante y orientable para ducha de mano.
- Ducha de mano anticalcárea de latón: Ø 78 mm.
- Flexo metálico reforzado.

	24217703	539,00
	24217703AC	835,00
	24217703LV	755,00
	24217703LM	755,00



Kit de grifo monomando empotrado de 2 vías para bañera y ducha

- Cuerpo empotrado incluido.
- Inversor de 2 vías.
- Conjunto de barra de ducha con rociador de ducha orientable de latón: Ø 310 mm.
- Inversor integrado en la barra de ducha.
- Soporte deslizante y orientable para ducha de mano.
- Ducha de mano anticalcárea de latón: Ø 78 mm.
- Flexo metálico reforzado.

	24218006	646,00
	24218006AC	1.001,00
	24218006LV	904,00
	24218006LM	904,00



GRIFOS PARA BAÑERA

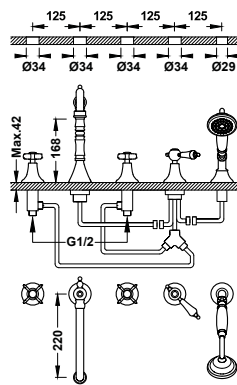

Grifo bimando para borde de bañera

- Con volantes e inversor.
- Ducha de mano anticalcárea de latón: Ø 78 mm.
- Caudal: 3 bar - 12 l/min.

	24214601	560,00
	24214601AC	868,00
	24214601OR	1.120,00
	24214601LV	784,00
	24214601LM	784,00

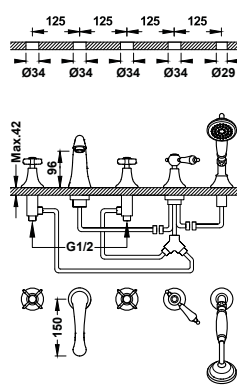

Grifo bimando para borde de bañera

- Con volantes e inversor.
- Ducha de mano anticalcárea de latón: Ø 78 mm.
- Caudal: 3 bar - 12 l/min.

	24214602	555,00
	24214602AC	860,00
	24214602OR	1.110,00
	24214602LV	777,00
	24214602LM	777,00

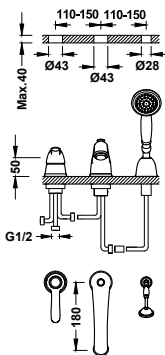

Grifo monomando para borde de bañera

- Inversor integrado en el caño de bañera.
- Ducha de mano anticalcárea de latón: Ø 78 mm.
- Caño de bañera de 180 mm. Caudal: 3 bar - 16 l/min.

	24214501	445,00
	24214501AC	690,00
	24214501OR	890,00
	24214501LV	623,00
	24214501LM	623,00

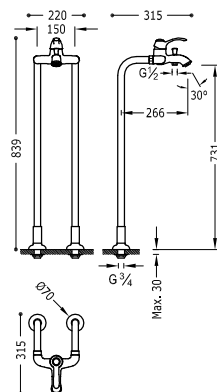

Grifo monomando a suelo para bañera y ducha

- Con 2 columnas verticales de alimentación de agua a suelo. Ducha de mano anticalcárea de latón: Ø 78 mm. Soporte fijo para ducha de mano. Flexo metálico reforzado.

	24219402	617,00
	24219402AC	956,00
	24219402LV	864,00
	24219402LM	864,00



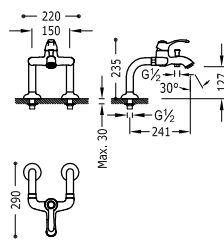

Grifo monomando para borde de bañera con tomas de agua acodadas

Con 2 tomas de agua acodadas. Ducha de mano anticalcárea de latón: Ø 78 mm. Soporte fijo para ducha de mano. Flexo metálico reforzado.

24219401 437,00

24219401AC 677,00

24219401OR 874,00

24219401LV 612,00

24219401LM 612,00



GRIFOS TERMOSTÁTICOS MURALES

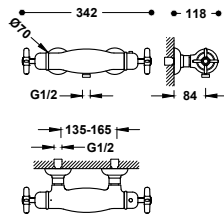

Grifo termostático mural para ducha

Ducha de mano anticalcárea de latón: Ø 78 mm. Soporte orientable para ducha de mano. Flexo metálico reforzado.

24216409 465,00

24216409AC 721,00

24216409OR 930,00

24216409LV 651,00

24216409LM 651,00

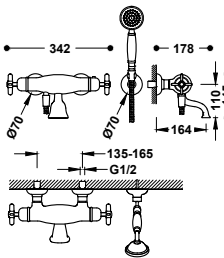

Grifo termostático mural para bañera y ducha

Con salida del agua en cascada. Inversor integrado en el regulador de caudal. Ducha de mano anticalcárea de latón: Ø 78 mm. Soporte orientable para ducha de mano. Flexo metálico reforzado.

24217409 515,00

24217409AC 798,00

24217409OR 1.030,00

24217409LV 721,00

24217409LM 721,00

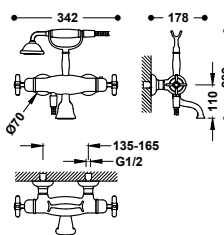

Grifo termostático mural para bañera y ducha

Con salida del agua en cascada. Inversor integrado en el regulador de caudal. Ducha de mano anticalcárea de latón: Ø 78 mm. Soporte fijo para ducha de mano. Flexo metálico reforzado.

24217609 650,00

24217609AC 1.008,00

24217609OR 1.300,00

24217609LV 910,00

24217609LM 910,00



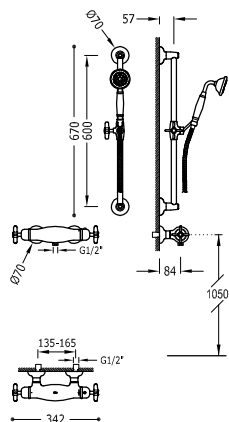

Kit de grifo termostático mural para ducha

- Barra de ducha: long. 600 mm.
- Soporte deslizante y orientable para ducha de mano.
- Ducha de mano anticalcárea de latón: Ø 78 mm.
- Flexo metálico reforzado.

	24216402	641,00
	24216402AC	994,00
	24216402LV	897,00
	24216402LM	897,00

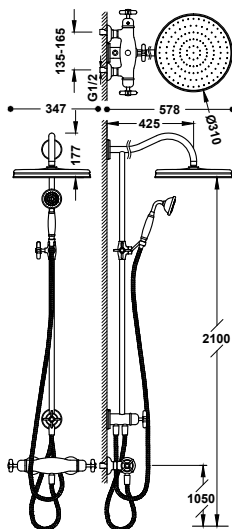

Conjunto de grifo termostático mural de 1 vía para ducha

- Con inversor integrado en la barra de ducha.
- Rociador de ducha orientable de latón: Ø 310 mm.
- Soporte deslizante y orientable para ducha de mano.
- Ducha de mano anticalcárea de latón: Ø 78 mm.
- Flexo metálico reforzado.

	24219501	894,00
	24219501AC	1.386,00
	24219501LV	1.252,00
	24219501LM	1.252,00

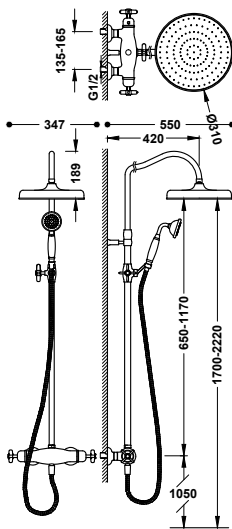

Conjunto de grifo termostático mural de 2 vías para ducha

- Con inversor integrado en el regulador de caudal.
- Barra de ducha telescópica.
- Rociador de ducha orientable de latón: Ø 310 mm.
- Soporte deslizante y orientable para ducha de mano.
- Ducha de mano anticalcárea de latón: Ø 78 mm.
- Flexo metálico reforzado.



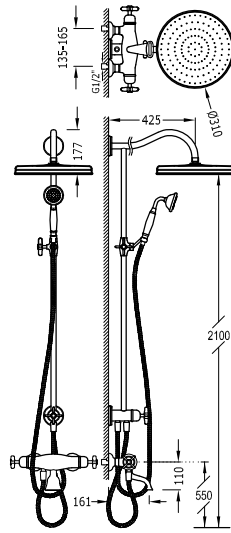

	24219502	1.065,00
	24219502AC	1.651,00
	24219502LV	1.491,00
	24219502LM	1.491,00





Conjunto de grifo termostático mural de 2 vías para bañera y ducha



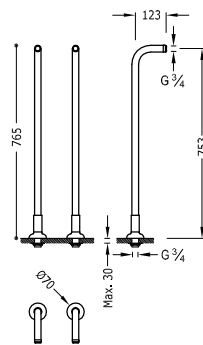
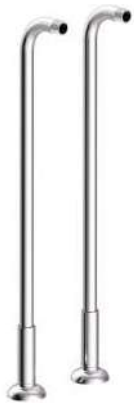

- Con inversor integrado en el regulador de caudal y en la barra de ducha.
- Salida del agua en cascada.
- Rociador de ducha orientable de latón: Ø 310 mm.
- Soporte deslizante y orientable para ducha de mano.
- Ducha de mano anticalcárea de latón: Ø 78 mm.
- Flexo metálico reforzado.

	24219801	950,00
	24219801AC	1.473,00
	24219801LV	1.330,00
	24219801LM	1.330,00



Tomas de agua acodadas de instalación a suelo para grifo de bañera



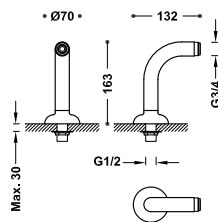

2 columnas verticales de alimentación de agua a suelo.

	24219403	350,00
	24219403AC	543,00
	24219403LV	490,00
	24219403LM	490,00



Tomas de agua acodadas de instalación a borde bañera para grifo de bañera

2 unidades con silenciador.



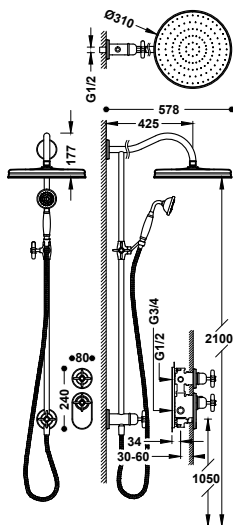

	24287101	150,00
	24287101AC	233,00
	24287101OR	300,00
	24287101LV	210,00
	24287101LM	210,00

GRIFOS TERMOSTÁTICOS EMPOTRADOS



Kit de grifo termostático empotrado de 1 vía Block System para ducha

- Cuerpo empotrado termostático de instalación vertical incluido.
- Regulador de caudal y distribuidor de 1 vía.
- Conjunto de barra de ducha con rociador de ducha orientable de latón: Ø 310 mm.
- Inversor integrado en la barra de ducha.
- Soporte deslizante y orientable para ducha de mano.
- Ducha de mano anticalcárea de latón: Ø 78 mm.
- Flexo metálico reforzado.

	24235203	1.026,00
	24235203AC	1.590,00
	24235203LV	1.436,00
	24235203LM	1.436,00





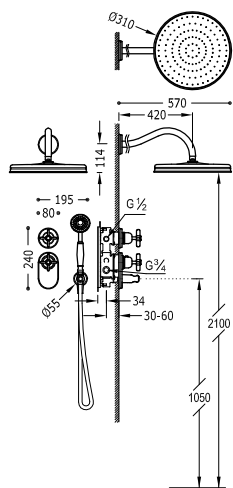

29916802XX



Kit de grifo termostático empotrado de 2 vías Block System para ducha

- Cuerpo empotrado termostático de instalación vertical incluido.
- Regulador de caudal y distribuidor de 2 vías.
- Brazo a pared con rociador de ducha orientable de latón: Ø 310 mm.
- Soporte para ducha de mano con toma de agua a pared.
- Ducha de mano anticalcárea de latón: Ø 78 mm.
- Flexo metálico reforzado.

	24235202	1.034,00
	24235202AC	1.603,00
	24235202OR	2.068,00
	24235202LV	1.448,00
	24235202LM	1.448,00





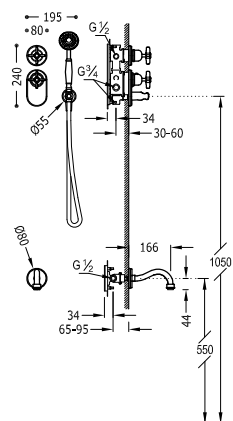

29916802XX



Kit de grifo termostático empotrado de 2 vías Block System para bañera y ducha

- Cuerpo empotrado termostático de instalación vertical incluido.
- Regulador de caudal y distribuidor de 2 vías.
- Caño fijo de bañera a pared.
- Soporte para ducha de mano con toma de agua a pared.
- Ducha de mano anticalcárea de latón: Ø 78 mm.
- Flexo metálico reforzado.

	24235201	789,00
	24235201AC	1.223,00
	24235201OR	1.578,00
	24235201LV	1.105,00
	24235201LM	1.105,00



29916802XX

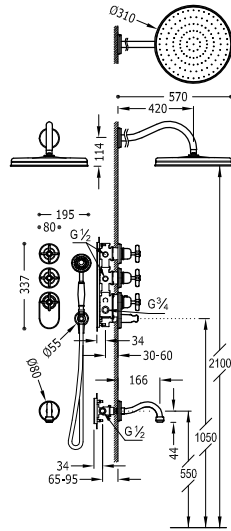

Kit de grifo termostático empotrado de 3 vías Block System para bañera y ducha

- Cuerpo empotrado termostático de instalación vertical incluido.
- Regulador de caudal y distribuidor de 3 vías.
- Brazo a pared con rociador de ducha orientable de latón: Ø 310 mm.
- Caño fijo de bañera a pared.
- Soporte para ducha de mano con toma de agua a pared.
- Ducha de mano anticalcárea de latón: Ø 78 mm.
- Flexo metálico reforzado.

	24235301	1.331,00
	24235301AC	2.063,00
	24235301OR	2.662,00
	24235301LV	1.863,00
	24235301LM	1.863,00

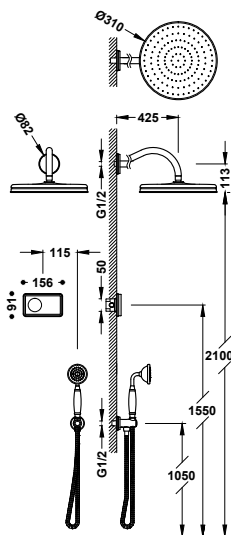

Kit de grifo termostático electrónico empotrado de 2 vías Shower Technology Blue Edition para ducha

- Control electrónico blanco incluido con juntas antihumedad Schlüter.
- Centralita termostática electrónica incluida de 2 vías.
- Brazo a pared con rociador de ducha orientable de latón: Ø 310 mm.
- Soporte para ducha de mano con toma de agua a pared.
- Ducha de mano anticalcárea de latón: Ø 78 mm.
- Flexo metálico reforzado.

	09226201	1.120,00
	09226201AC	1.562,00
	09226201OR	1.868,00
	09226201LV	1.494,00
	09226201LM	1.494,00

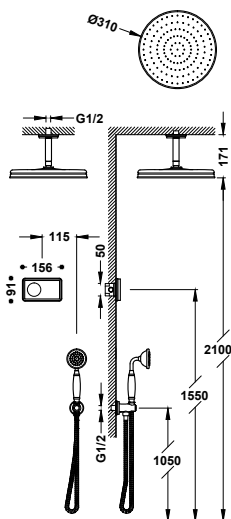

Kit de grifo termostático electrónico empotrado de 2 vías Shower Technology Blue Edition para ducha

- Control electrónico blanco incluido con juntas antihumedad Schlüter.
- Centralita termostática electrónica incluida de 2 vías.
- Brazo a techo con rociador de ducha orientable de latón: Ø 310 mm.
- Soporte para ducha de mano con toma de agua a pared.
- Ducha de mano anticalcárea de latón: Ø 78 mm.
- Flexo metálico reforzado.





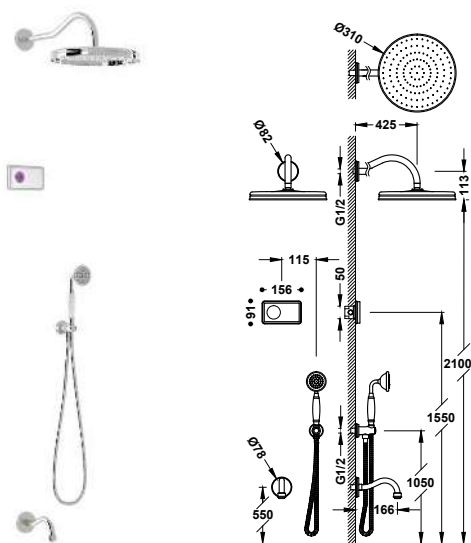

	09226202	1.155,00
	09226202AC	1.520,00
	09226202OR	1.814,00
	09226202LV	1.462,00
	09226202LM	1.462,00





Kit de grifo termostático electrónico empotrado de 3 vías Shower Technology Blue Edition para bañera y ducha

- Control electrónico blanco incluido con juntas antihumedad Schlüter.
- Centralita termostática electrónica incluida de 3 vías.
- Brazo a pared con rociador de ducha orientable de latón: Ø 310 mm.
- Caño fijo de bañera a pared.
- Soporte para ducha de mano con toma de agua a pared.
- Ducha de mano anticalcárea de latón: Ø 78 mm.
- Flexo metálico reforzado.

	09226301	1.317,00
	09226301AC	1.747,00
	09226301OR	2.097,00
	09226301LV	1.661,00
	09226301LM	1.661,00
		

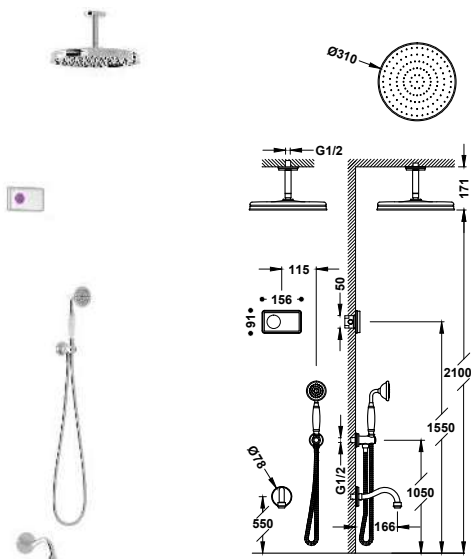

Kit de grifo termostático electrónico empotrado de 3 vías Shower Technology Blue Edition para bañera y ducha

- Control electrónico blanco incluido con juntas antihumedad Schlüter.
- Centralita termostática electrónica incluida de 3 vías.
- Brazo a techo con rociador de ducha orientable de latón: Ø 310 mm.
- Caño fijo de bañera a pared.
- Soporte para ducha de mano con toma de agua a pared.
- Ducha de mano anticalcárea de latón: Ø 78 mm.
- Flexo metálico reforzado.

	09226302	1.290,00
	09226302AC	1.706,00
	09226302OR	2.026,00
	09226302LV	1.629,00
	09226302LM	1.629,00
		





GRIFOS PARA VARIOS USOS

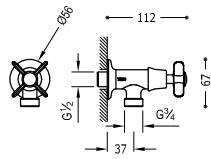

Grifo empotrado de 1 agua para lavadora
Con conexión roscada de G1/2.

- 24250001 **83,50**
- 24250001AC **129,00**
- 24250001OR **167,00**
- 24250001LV **117,00**
- 24250001LM **117,00**

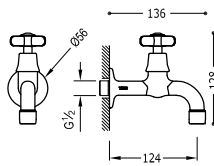

Grifo empotrado de 1 agua para office o lavadero
Con conexión roscada de G1/2.

- 24252001 **98,00**
- 24252001AC **152,00**
- 24252001OR **196,00**
- 24252001LV **137,00**
- 24252001LM **137,00**



LLAVES DE PASO

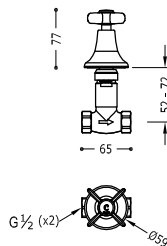

Llave de paso empotrada
Con conexión roscada de G1/2. Índice cerámico (frío).

- 24215501 **89,00**
- 24215501AC **138,00**
- 24215501OR **178,00**
- 24215501LV **125,00**
- 24215501LM **125,00**

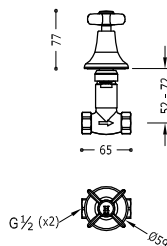

Llave de paso empotrada
Con conexión roscada de G1/2. Índice cerámico (caliente).

- 24215502 **89,00**
- 24215502AC **138,00**
- 24215502OR **178,00**
- 24215502LV **125,00**
- 24215502LM **125,00**



SLIM

Líneas estilizadas y esbeltas para una exclusividad incomparable. La finura de las piezas de la serie Slim y la elegancia de sus acabados subrayan su longitud y enfatizan un estilo único, personal y contemporáneo.

Acabados disponibles:



CR



NM



BM



AC



OR



OM







GRIFOS PARA LAVABO

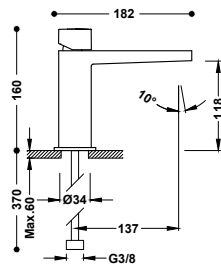

Grifo monomando para lavabo
Latiguillos de alimentación flexibles G3/8.



- 20210302 **184,00**
- 20210302D **206,00**

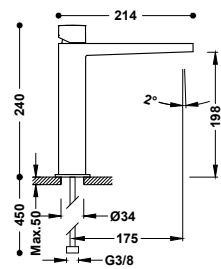

Grifo monomando alto para lavabo
Latiguillos de alimentación flexibles G3/8.



- 20210304 **345,00**

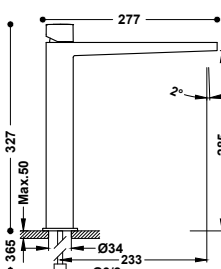

Grifo monomando XXL para lavabo
Latiguillos de alimentación flexibles G3/8.



- 20210306 **380,00**

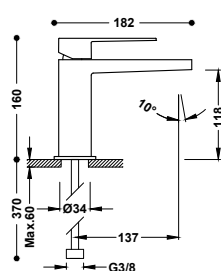

Grifo monomando para lavabo
Latiguillos de alimentación flexibles G3/8.



- 20210301 **184,00**
- 20210301D **206,00**
- 20210301NM **285,00**
- 20210301BM **285,00**
- 20210301AC **285,00**
- 20210301OR **368,00**
- 20210301OM **368,00**

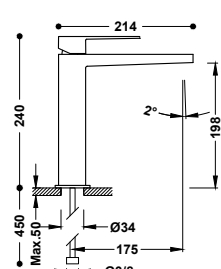

Grifo monomando alto para lavabo
Latiguillos de alimentación flexibles G3/8.



- 20210303 **345,00**
- 20210303NM **535,00**
- 20210303BM **535,00**
- 20210303AC **535,00**
- 20210303OR **690,00**
- 20210303OM **690,00**

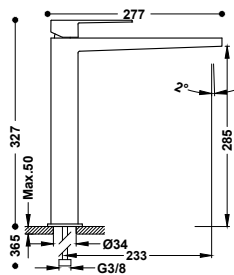

Grifo monomando XXL para lavabo
Latiguillos de alimentación flexibles G3/8.



9130190

- 20210305 **380,00**
- 20210305NM **589,00**
- 20210305BM **589,00**
- 20210305AC **589,00**
- 20210305OR **760,00**
- 20210305OM **760,00**

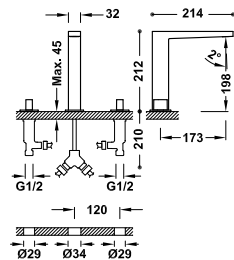

Grifo bimando de repisa para lavabo
De instalación libre. Con volantes.



29910501

- 20210501 **370,00**
- 20210501NM **574,00**
- 20210501BM **574,00**
- 20210501AC **574,00**
- 20210501OR **740,00**
- 20210501OM **740,00**

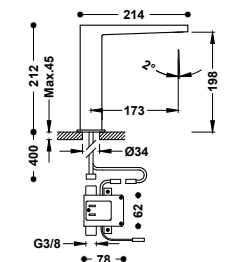

Grifo electrónico de 1 agua para lavabo
Accionado mediante sensor de infrarrojos.



- 20261310 **340,00**
- 20261310NM **527,00**
- 20261310BM **527,00**
- 20261310AC **527,00**
- 20261310OR **680,00**
- 20261310OM **680,00**

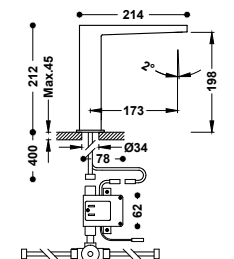

Grifo electrónico con sistema premezclador para lavabo
Accionado mediante sensor de infrarrojos. Incluye una válvula mezcladora de 2 aguas con tubos flexibles (ref. 19250730).



- 20261320 **380,00**
- 20261320NM **589,00**
- 20261320BM **589,00**
- 20261320AC **589,00**
- 20261320OR **760,00**
- 20261320OM **760,00**

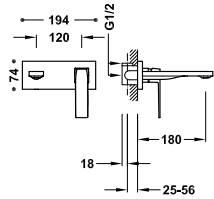

Grifo monomando empotrado para lavabo

Cuerpo empotrado indivisible con amortiguadores acústicos. Junta antihumedad. Caño de 180 mm.



29902801

- 20230011 **290,00**
- 20230011NM **450,00**
- 20230011BM **450,00**
- 20230011AC **450,00**
- 20230011OR **580,00**
- 20230011OM **580,00**

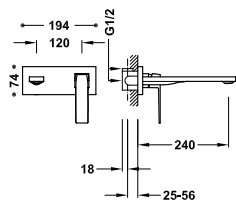

Grifo monomando empotrado para lavabo

Cuerpo empotrado indivisible con amortiguadores acústicos. Junta antihumedad. Caño de 240 mm.



29902801

- 20230012 **300,00**
- 20230012NM **465,00**
- 20230012BM **465,00**
- 20230012AC **465,00**
- 20230012OR **600,00**
- 20230012OM **600,00**

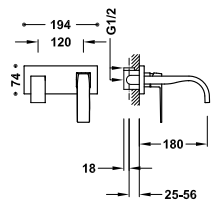

Grifo monomando empotrado para lavabo

Cuerpo empotrado indivisible con amortiguadores acústicos. Junta antihumedad. Caño de 180 mm.



29902801

- 20230013 **305,00**
- 20230013NM **473,00**
- 20230013BM **473,00**
- 20230013AC **473,00**
- 20230013OR **610,00**
- 20230013OM **610,00**

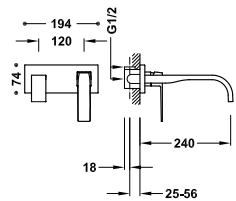

Grifo monomando empotrado para lavabo

Cuerpo empotrado indivisible con amortiguadores acústicos. Junta antihumedad. Caño de 240 mm.



29902801

- 20230014 **315,00**
- 20230014NM **488,00**
- 20230014BM **488,00**
- 20230014AC **488,00**
- 20230014OR **630,00**
- 20230014OM **630,00**

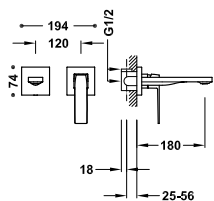

Grifo monomando empotrado para lavabo

Cuerpo empotrado indivisible con amortiguadores acústicos. Junta antihumedad. Caño de 180 mm.



29902801

- 20230001 **255,00**
- 20230001NM **395,00**
- 20230001BM **395,00**
- 20230001AC **395,00**
- 20230001OR **510,00**
- 20230001OM **510,00**

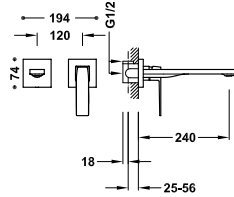

Grifo monomando empotrado para lavabo

Cuerpo empotrado indivisible con amortiguadores acústicos. Junta antihumedad. Caño de 240 mm.



- 20230002 **265,00**
- 20230002NM **411,00**
- 20230002BM **411,00**
- 20230002AC **411,00**
- 20230002OR **530,00**
- 20230002OM **530,00**

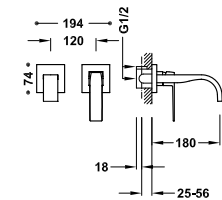

Grifo monomando empotrado para lavabo

Cuerpo empotrado indivisible con amortiguadores acústicos. Junta antihumedad. Caño de 180 mm.



- 20230003 **270,00**
- 20230003NM **419,00**
- 20230003BM **419,00**
- 20230003AC **419,00**
- 20230003OR **540,00**
- 20230003OM **540,00**

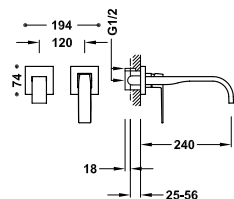

Grifo monomando empotrado para lavabo

Cuerpo empotrado indivisible con amortiguadores acústicos. Junta antihumedad. Caño de 240 mm.



- 20230004 **280,00**
- 20230004NM **434,00**
- 20230004BM **434,00**
- 20230004AC **434,00**
- 20230004OR **560,00**
- 20230004OM **560,00**

GRIFOS PARA BIDÉ

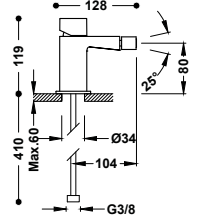

Grifo monomando para bidé

Rótula orientable. Latiguillos de alimentación flexibles G3/8.



- 20212002 **187,00**
- 20212002D **209,00**

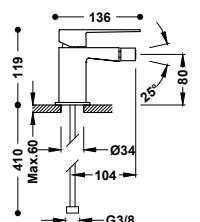

Grifo monomando para bidé

Rótula orientable. Latiguillos de alimentación flexibles G3/8.



- 20212001 **187,00**
- 20212001D **209,00**
- 20212001NM **290,00**
- 20212001BM **290,00**
- 20212001AC **290,00**
- 20212001OR **374,00**
- 20212001OM **374,00**



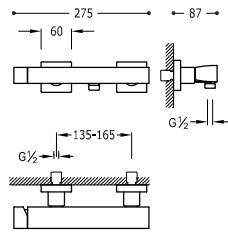



GRIFOS MURALES



Grifo monomando mural para ducha

Ducha de mano anticalcárea de latón. Soporte orientable para ducha de mano. Flexo satinado.





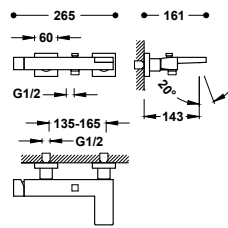



	20216701	328,00
	20216701NM	508,00
	20216701BM	508,00
	20216701AC	508,00
	20216701OR	656,00
	20216701OM	656,00



Grifo monomando mural para bañera y ducha

Ducha de mano anticalcárea de latón. Soporte orientable para ducha de mano. Flexo satinado.





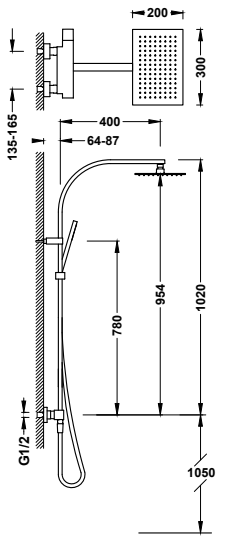

	20217001	348,00
	20217001NM	539,00
	20217001BM	539,00
	20217001AC	539,00
	20217001OR	696,00
	20217001OM	696,00



Conjunto de grifo monomando mural de 2 vías para ducha

- Rociador de ducha orientable de acero inoxidable: 300x200 mm.
- Soporte deslizante y orientable para ducha de mano.
- Ducha de mano anticalcárea de latón.
- Flexo satinado.



	20219101	720,00
	20219101NM	1.116,00
	20219101BM	1.116,00
	20219101AC	1.116,00

GRIFOS EMPOTRADOS RAPID-BOX

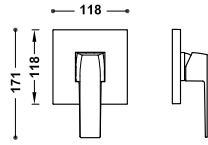

Pieza vista para caja empotrada de 1 vía Rapid-box
 Sólo parte vista. Incluye placa embellecedora, mando, casquillo y tornillo de fijación oculto. **Caja empotrada no incluida.**

	20227810	85,00
	20227810NM	132,00
	20227810BM	132,00
	20227810AC	132,00
	20227810OR	170,00
	20227810OM	170,00



Caja empotrada de 1 vía Rapid-box con grifo monomando para ducha

20827810 **80,00**

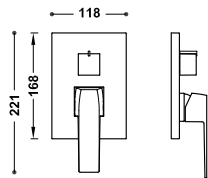

Pieza vista para caja empotrada de 2 vías Rapid-box
 Sólo parte vista. Incluye placa embellecedora, mando, volante distribuidor y tornillo de fijación oculto. **Caja empotrada no incluida.**

	20228110	110,00
	20228110NM	171,00
	20228110BM	171,00
	20228110AC	171,00
	20228110OR	220,00
	20228110OM	220,00



Caja empotrada de 2 vías Rapid-box con grifo monomando para ducha y bañera

20828110 **90,00**

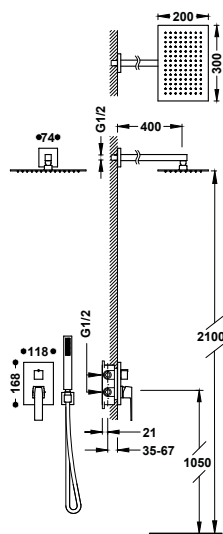

Kit de grifo monomando empotrado de 2 vías Rapid-box para ducha

- Cuerpo empotrado incluido.
- Distribuidor cerámico de 2 vías.
- Brazo a pared con rociador de ducha orientable y de acero inoxidable: 300x200 mm.
- Soporte para ducha de mano con toma de agua a pared.
- Ducha de mano anticalcárea de latón.
- Flexo satinado.





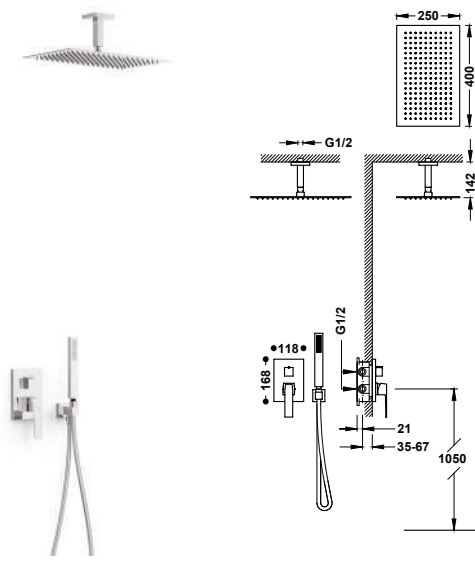

	20228004	599,00
	20228004NM	928,00
	20228004BM	928,00
	20228004AC	928,00
	20228004OR	1.198,00
	20228004OM	1.198,00





Kit de grifo monomando empotrado de 2 vías Rapid-box para ducha





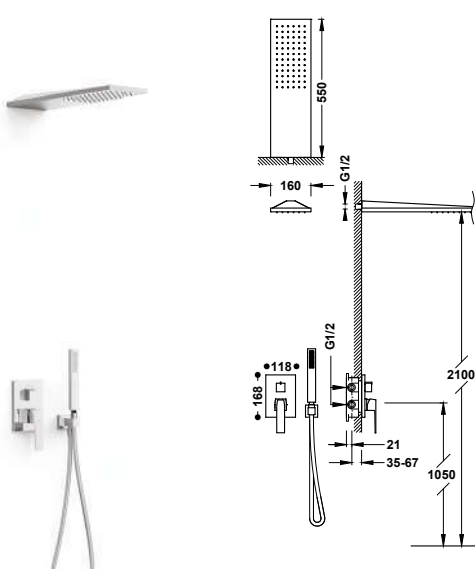

- Cuerpo empotrado incluido.
- Distribuidor cerámico de 2 vías.
- Brazo a techo con rociador de ducha orientable y de acero inoxidable: 400x250 mm.
- Soporte para ducha de mano con toma de agua a pared.
- Ducha de mano anticalcárea de latón.
- Flexo satinado.

	20228003	624,00
	20228003NM	967,00
	20228003BM	967,00
	20228003AC	967,00
	20228003OR	1.248,00
	20228003OM	1.248,00



Kit de grifo monomando empotrado de 2 vías Rapid-box para ducha





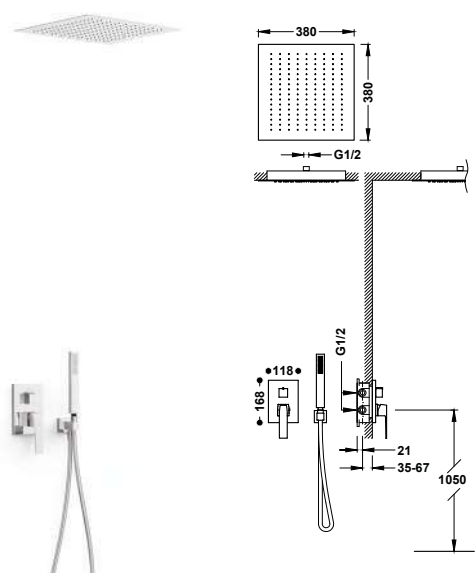

- Cuerpo empotrado incluido.
- Distribuidor cerámico de 2 vías.
- Rociador de ducha a pared de acero inoxidable: 160x560 mm.
- Soporte para ducha de mano con toma de agua a pared.
- Ducha de mano anticalcárea de latón.
- Flexo satinado.

	20228005	743,00
	20228005NM	1.152,00
	20228005BM	1.152,00
	20228005AC	1.152,00
	20228005OR	1.486,00
	20228005OM	1.486,00



Kit de grifo monomando empotrado de 2 vías Rapid-box para ducha

- Cuerpo empotrado incluido.
- Distribuidor cerámico de 2 vías.
- Rociador de ducha empotrado a techo de acero inoxidable: 380x380 mm.
- Soporte para ducha de mano con toma de agua a pared.
- Ducha de mano anticalcárea de latón.
- Flexo satinado.





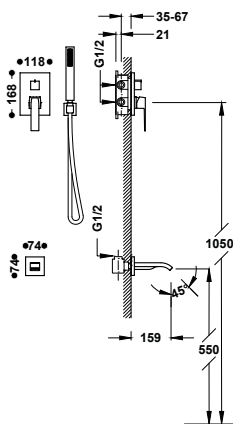

	20228006	1.080,00
	20228006NM	1.674,00
	20228006BM	1.674,00
	20228006AC	1.674,00
	20228006OR	2.160,00
	20228006OM	2.160,00





Kit de grifo monomando empotrado de 2 vías Rapid-box para bañera y ducha

- Cuerpo empotrado incluido.
- Distribuidor cerámico de 2 vías.
- Caño fijo de bañera a pared.
- Soporte para ducha de mano con toma de agua a pared.
- Ducha de mano anticalcárea de latón.
- Flexo satinado.

	20228007	472,00
	20228007NM	732,00
	20228007BM	732,00
	20228007AC	732,00
	20228007OR	944,00
	20228007OM	944,00





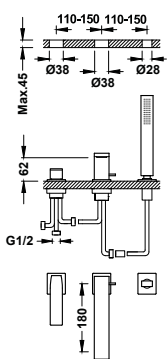



GRIFOS PARA BAÑERA



Grifo monomando para borde de bañera

- Inversor integrado en el caño de bañera.
- Ducha de mano anticalcárea de latón.
- Caño de bañera de 180 mm. Caudal: 3 bar - 13 l/m.
- Kit depósito opcional no incluido ref: 20224501.

	20216103	490,00
	20216103NM	760,00
	20216103BM	760,00
	20216103AC	760,00
	20216103OR	980,00
	20216103OM	980,00







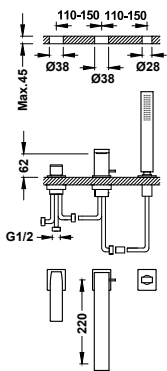

Depósito para grifería de borde de bañera

	20224501	395,00
---	----------	---------------



Grifo monomando para borde de bañera

- Inversor integrado en el caño de bañera.
- Ducha de mano anticalcárea de latón.
- Caño de bañera de 220 mm. Caudal: 3 bar - 13 l/m.
- Kit depósito opcional no incluido ref: 20224501.

	20216101	500,00
	20216101NM	775,00
	20216101BM	775,00
	20216101AC	775,00
	20216101OR	1.000,00
	20216101OM	1.000,00



Depósito para grifería de borde de bañera

	20224501	395,00
---	----------	---------------

GRIFOS TERMOSTÁTICOS MURALES

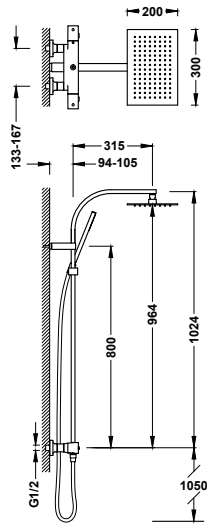

Conjunto de grifo termostático mural Over-wall de 2 vías para ducha

- Con inversor integrado en el regulador de caudal.
- Volante cuadrado.
- Rociador de ducha orientable de acero inoxidable: 300x200 mm.
- Soporte deslizante y orientable para ducha de mano.
- Ducha de mano anticalcárea de latón.
- Flexo satinado.

19039306	691,00
19039306NM	1.071,00
19039306BM	1.071,00
19039306AC	1.071,00
19039306OM	1.382,00



GRIFOS TERMOSTÁTICOS EMPOTRADOS

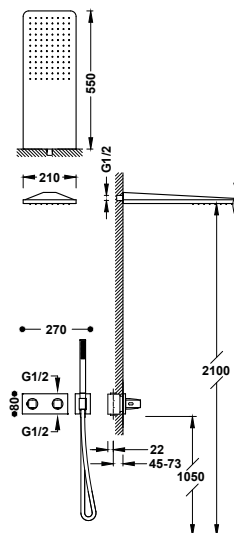

Kit de grifo termostático empotrado de 2 vías B-system para ducha

- Cuerpo empotrado termostático de instalación horizontal incluido.
- Regulador de caudal y distribuidor cerámico de 2 vías.
- Volante cuadrado-redondo.
- Rociador de ducha a pared de acero inoxidable: 210x550 mm.
- Soporte para ducha de mano con toma de agua a pared.
- Ducha de mano anticalcárea de latón.
- Flexo satinado.





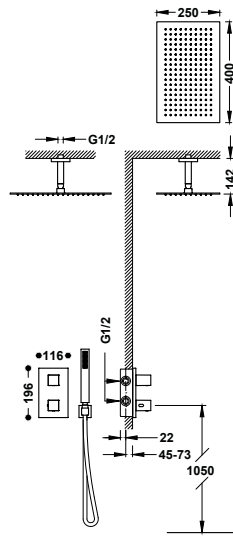

30725205	1.187,00
30725205NM	1.840,00
30725205AC	1.840,00
30725205OR	2.374,00
30725205OM	2.374,00





Kit de grifo termostático empotrado de 2 vías Therm-box para ducha





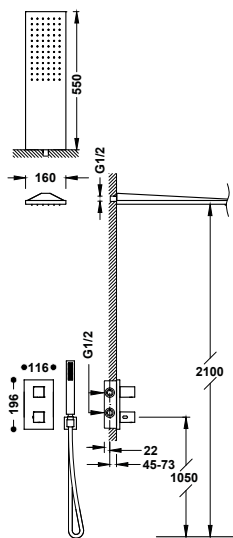

- Cuerpo empotrado incluido.
- Volante cuadrado con control de temperatura. Distribuidor cerámico de 2 vías.
- Brazo a techo con rociador de ducha orientable y de acero inoxidable: 400x250 mm.
- Soporte para ducha de mano con toma de agua a pared.
- Ducha de mano anticalcárea de latón.
- Flexo satinado.

	20225053	684,00
	20225053NM	1.060,00
	20225053BM	1.060,00
	20225053AC	1.060,00
	20225053OR	1.368,00
	20225053OM	1.368,00



Kit de grifo termostático empotrado de 2 vías Therm-box para ducha

- Cuerpo empotrado incluido.
- Volante cuadrado con control de temperatura. Distribuidor cerámico de 2 vías.
- Rociador de ducha a pared de acero inoxidable: 160x550 mm.
- Soporte para ducha de mano con toma de agua a pared.
- Ducha de mano anticalcárea de latón.
- Flexo satinado.

	20225055	803,00
	20225055NM	1.245,00
	20225055BM	1.245,00
	20225055AC	1.245,00
	20225055OR	1.606,00
	20225055OM	1.606,00

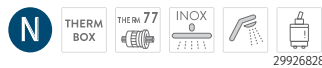



STUDY

Simple a la vez que extravagante. Los cuerpos cilíndricos y delgados de Study aspiran al equilibrio atemporal. Un diseño minimalista y armonioso con acabados metálicos que sorprenden.

Acabados disponibles:

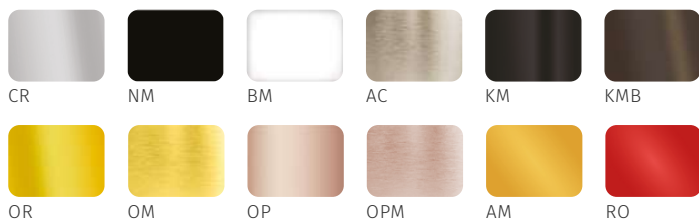









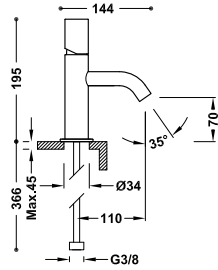









GRIFOS PARA LAVABO

Grifo monomando para lavabo
Latiguillos de alimentación flexibles G3/8.



-  26190301 **165,00**
-  26190301D **187,00**

-  26190301NM **256,00**
-  26190301BM **256,00**
-  26190301AC **256,00**
-  26190301KM **256,00**
-  26190301KMB **256,00**
-  26190301OR **330,00**
-  26190301OM **330,00**
-  26190301OP **330,00**
-  26190301OPM **330,00** N
-  26190301TAM **256,00**
-  26190301TRO **256,00**







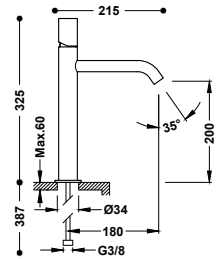





910719005

Grifo monomando alto para lavabo
Latiguillos de alimentación flexibles G3/8.



-  26130701 **297,00**

-  26130701NM **460,00**
-  26130701BM **460,00**
-  26130701AC **460,00**
-  26130701KM **460,00**
-  26130701KMB **460,00**
-  26130701OR **594,00**
-  26130701OM **594,00**
-  26130701OP **594,00**
-  26130701OPM **594,00** N
-  26130701TAM **460,00**
-  26130701TRO **460,00**







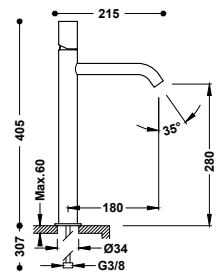





910719005

Grifo monomando XXL para lavabo
Latiguillos de alimentación flexibles G3/8.



-  26130801 **325,00**

-  26130801NM **504,00**
-  26130801BM **504,00**
-  26130801AC **504,00**
-  26130801KM **504,00**
-  26130801KMB **504,00**
-  26130801OR **650,00**
-  26130801OM **650,00**
-  26130801OP **650,00**
-  26130801OPM **650,00** N
-  26130801TAM **504,00**
-  26130801TRO **504,00**



910719005

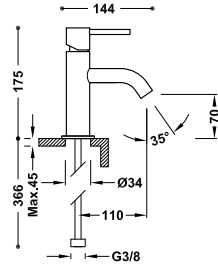

Grifo monomando para lavabo
Latiguillos de alimentación flexibles G3/8.

- 26290301 **165,00**
- 26290301D **187,00**
- 26290301NM **256,00**
- 26290301BM **256,00**
- 26290301AC **256,00**
- 26290301KM **256,00**
- 26290301KMB **256,00**
- 26290301OR **330,00**
- 26290301OM **330,00**
- 26290301OP **330,00**
- 26290301OPM **330,00**
- 26290301TAM **256,00**
- 26290301TRO **256,00**



Grifo monomando alto para lavabo
Latiguillos de alimentación flexibles G3/8.

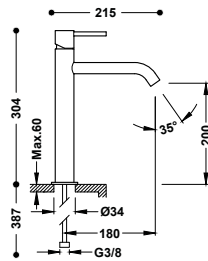

- 26230701 **297,00**
- 26230701NM **460,00**
- 26230701BM **460,00**
- 26230701AC **460,00**
- 26230701KM **460,00**
- 26230701KMB **460,00**
- 26230701OR **594,00**
- 26230701OM **594,00**
- 26230701OP **594,00**
- 26230701OPM **594,00**
- 26230701TAM **460,00**
- 26230701TRO **460,00**



Grifo monomando XXL para lavabo
Latiguillos de alimentación flexibles G3/8.

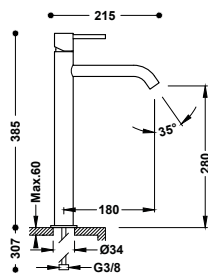

- 26230801 **325,00**
- 26230801NM **504,00**
- 26230801BM **504,00**
- 26230801AC **504,00**
- 26230801KM **504,00**
- 26230801KMB **504,00**
- 26230801OR **650,00**
- 26230801OM **650,00**
- 26230801OP **650,00**
- 26230801OPM **650,00**
- 26230801TAM **504,00**
- 26230801TRO **504,00**



Grifo monomando con maneta lateral para lavabo
 Latiguillos de alimentación flexibles G3/8.

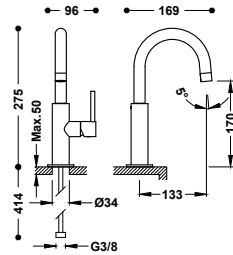

	26290403	210,00
	26290403NM	326,00
	26290403BM	326,00
	26290403AC	326,00
	26290403KM	326,00
	26290403KMB	326,00
	26290403OR	420,00
	26290403OM	420,00
	26290403OP	420,00
	26290403OPM	420,00
	26290403TAM	326,00
	26290403TRO	326,00

Grifo monomando alto con maneta lateral para lavabo
 Latiguillos de alimentación flexibles G3/8.

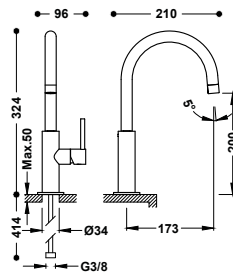

	26290402	220,00
	26290402NM	341,00
	26290402BM	341,00
	26290402AC	341,00
	26290402KM	341,00
	26290402KMB	341,00
	26290402OR	440,00
	26290402OM	440,00
	26290402OP	440,00
	26290402OPM	440,00
	26290402TAM	341,00
	26290402TRO	341,00

Grifo monomando XXL con maneta lateral para lavabo
 Latiguillos de alimentación flexibles G3/8.

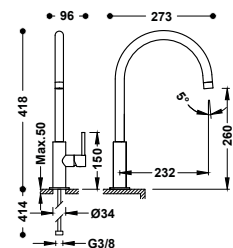

	26290401	230,00
	26290401NM	357,00
	26290401BM	357,00
	26290401AC	357,00
	26290401KM	357,00
	26290401KMB	357,00
	26290401OR	460,00
	26290401OM	460,00
	26290401OP	460,00
	26290401OPM	460,00
	26290401TAM	357,00
	26290401TRO	357,00

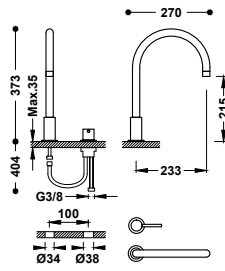

Grifo monomando de repisa para lavabo
De instalación libre.



- 26110501 **225,00**
- 26110501NM **349,00**
- 26110501BM **349,00**
- 26110501AC **349,00**
- 26110501KM **349,00**
- 26110501KMB **349,00**
- 26110501OR **450,00**
- 26110501OM **450,00**
- 26110501OP **450,00**
- 26110501OPM **450,00** N

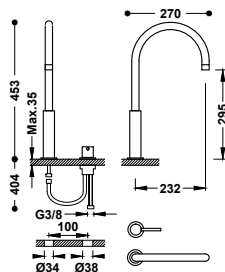

Grifo monomando alto de repisa para lavabo
De instalación libre.



- 26110502 **240,00**
- 26110502NM **372,00**
- 26110502BM **372,00**
- 26110502AC **372,00**
- 26110502KM **372,00**
- 26110502KMB **372,00**
- 26110502OR **480,00**
- 26110502OM **480,00**
- 26110502OP **480,00**
- 26110502OPM **480,00** N

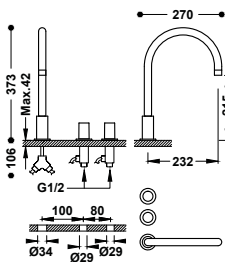

Grifo bimando de repisa para lavabo
De instalación libre. Con volantes.



- 06110501 **265,00**
- 06110501NM **411,00**
- 06110501BM **411,00**
- 06110501AC **411,00**
- 06110501KM **411,00**
- 06110501KMB **411,00**
- 06110501OR **530,00**
- 06110501OM **530,00**
- 06110501OP **530,00**
- 06110501OPM **530,00** N

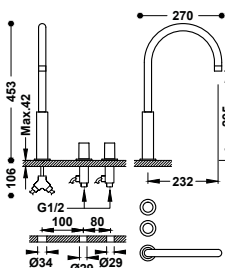







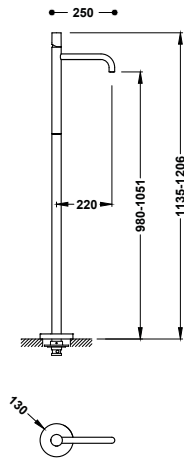



Grifo bimando alto de repisa para lavabo
De instalación libre. Con volantes.



- 06110502 **280,00**
- 06110502NM **434,00**
- 06110502BM **434,00**
- 06110502AC **434,00**
- 06110502KM **434,00**
- 06110502KMB **434,00**
- 06110502OR **560,00**
- 06110502OM **560,00**
- 06110502OP **560,00**
- 06110502OPM **560,00** N



Grifo monomando con toma a suelo para lavabo
1 columna vertical de alimentación de agua a suelo. Caja empotrada no incluida.

-  26285306 **550,00**
-  26285306NM **853,00**
-  26285306BM **853,00**
-  26285306AC **853,00**
-  26285306KM **853,00**
-  26285306KMB **853,00**
-  26285306OR **1.100,00**
-  26285306OM **1.100,00**
-  26285306OP **1.100,00**
-  26285306OPM **1.100,00**



910719005







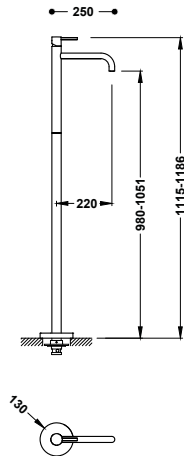





Base de empotramiento para montaje de grifos monomando a suelo

26285350 **180,00** N



Grifo monomando con toma a suelo para lavabo
1 columna vertical de alimentación de agua a suelo. Caja empotrada no incluida.

-  26285305 **550,00**
-  26285305NM **853,00**
-  26285305BM **853,00**
-  26285305AC **853,00**
-  26285305KM **853,00**
-  26285305KMB **853,00**
-  26285305OR **1.100,00**
-  26285305OM **1.100,00**
-  26285305OP **1.100,00**
-  26285305OPM **1.100,00**

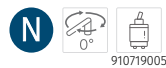

910719005



Base de empotramiento para montaje de grifos monomando a suelo

26285350 **180,00** N

Grifo monomando empotrado para lavabo

Cuerpo empotrado indivisible con amortiguadores acústicos. Junta antihumedad. Caño de 180 mm.

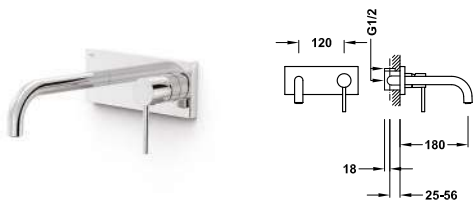

- 26230011 **300,00**
- 26230011NM **465,00**
- 26230011BM **465,00**
- 26230011AC **465,00**
- 26230011KM **465,00**
- 26230011KMB **465,00**
- 26230011OR **600,00**
- 26230011OM **600,00**
- 26230011OP **600,00**
- 26230011OPM **600,00** N

Grifo monomando empotrado para lavabo

Cuerpo empotrado indivisible con amortiguadores acústicos. Junta antihumedad. Caño de 240 mm.

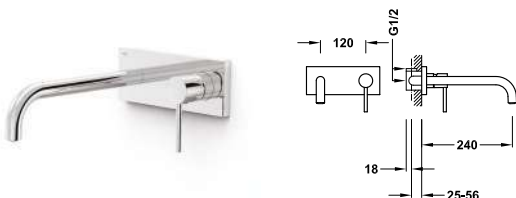

- 26230012 **310,00**
- 26230012NM **481,00**
- 26230012BM **481,00**
- 26230012AC **481,00**
- 26230012KM **481,00**
- 26230012KMB **481,00**
- 26230012OR **620,00**
- 26230012OM **620,00**
- 26230012OP **620,00**
- 26230012OPM **620,00** N

Grifo monomando empotrado para lavabo

Cuerpo empotrado indivisible con amortiguadores acústicos. Junta antihumedad. Caño de 177 mm.

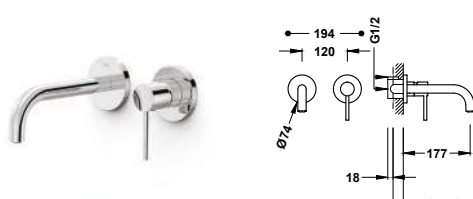

- 26230001 **262,00**
- 26230001NM **406,00**
- 26230001BM **406,00**
- 26230001AC **406,00**
- 26230001KM **406,00**
- 26230001KMB **406,00**
- 26230001OR **524,00**
- 26230001OM **524,00**
- 26230001OP **524,00**
- 26230001OPM **524,00**

Grifo monomando empotrado para lavabo

Cuerpo empotrado indivisible con amortiguadores acústicos. Junta antihumedad. Caño de 237 mm.

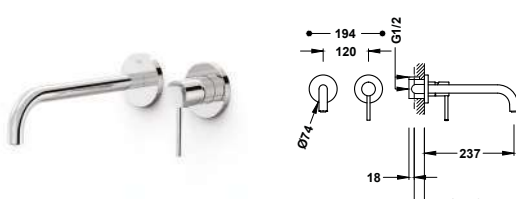

- 26230002 **272,00**
- 26230002NM **422,00**
- 26230002BM **422,00**
- 26230002AC **422,00**
- 26230002KM **422,00**
- 26230002KMB **422,00**
- 26230002OR **544,00**
- 26230002OM **544,00**
- 26230002OP **544,00**
- 26230002OPM **544,00** N

GRIFOS PARA BIDÉ

Grifo monomando para bidé

Rótula orientable. Latiguillos de alimentación flexibles G3/8.

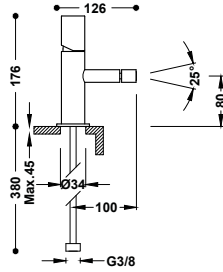

- 26112001 **168,00**
- 26112001D **190,00**

- 06112001NM **260,00**
- 06112001BM **260,00**
- 06112001AC **260,00**
- 06112001KM **260,00**
- 06112001KMB **260,00**
- 06112001OR **336,00**
- 06112001OM **336,00**
- 06112001OP **336,00**
- 06112001OPM **336,00** N
- 06112001TAM **260,00**
- 06112001TRO **260,00**

Grifo monomando para bidé

Rótula orientable. Latiguillos de alimentación flexibles G3/8.

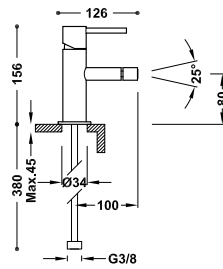

- 26212001 **168,00**
- 26212001D **190,00**

- 06212001NM **260,00**
- 06212001BM **260,00**
- 06212001AC **260,00**
- 06212001KM **260,00**
- 06212001KMB **260,00**
- 06212001OR **336,00**
- 06212001OM **336,00**
- 06212001OP **336,00**
- 06212001OPM **336,00**
- 06212001TAM **260,00**
- 06212001TRO **260,00**

Grifo monomando con maneta lateral para bidé

Rótula orientable. Latiguillos de alimentación flexibles G3/8.

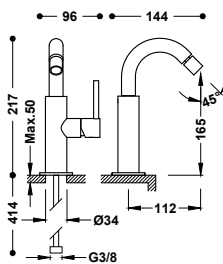

- 26222402 **210,00**

- 26222402NM **326,00**
- 26222402BM **326,00**
- 26222402AC **326,00**
- 26222402KM **326,00**
- 26222402KMB **326,00**
- 26222402OR **420,00**
- 26222402OM **420,00**
- 26222402OP **420,00**
- 26222402OPM **420,00** N
- 26222402TAM **326,00**
- 26222402TRO **326,00**

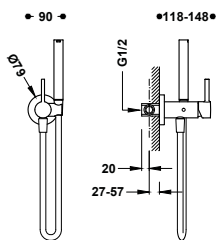

Grifo monomando empotrado con ducha para inodoro
 Con agua fría o caliente. Ducha de mano con racor limitador a 5 l/min. y sistema antigoteo. Soporte fijo para la ducha de mano instalable a derecha o izquierda. Flexo satinado.



- 134123 **178,00**
- 134123NM **276,00**
- 134123BM **276,00**
- 134123AC **276,00**
- 134123KM **276,00**
- 134123KMB **276,00**
- 134123OR **356,00**
- 134123OM **356,00**
- 134123OP **356,00**
- 134123OPM **356,00**

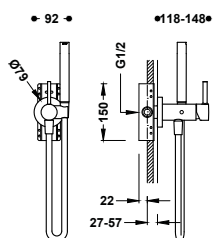

Grifo monomando empotrado con ducha para inodoro
 Opción para paredes de Pladur. Con agua fría o caliente. Ducha de mano con racor limitador a 5 l/min. y sistema antigoteo. Soporte fijo para la ducha de mano instalable a derecha o izquierda. Flexo satinado.



- 134122 **218,00**
- 134122NM **338,00**
- 134122BM **338,00**
- 134122AC **338,00**



Accesorio porta toallas para grifo con ducha para inodoro
 Soporte instalable a derecha o izquierda (para ref.: 134122, 134123, 181122, 181123, 181222, 181223, 20522201, 20522301). Long: 180 mm.

- 03412401 **35,00**
- 03412401NM **54,25**
- 03412401BM **54,25**
- 03412401AC **54,25**
- 03412401KM **54,25** N
- 03412401KMB **54,25** N
- 03412401OR **70,00** N
- 03412401OM **70,00** N
- 03412401OP **70,00** N
- 03412401OPM **70,00** N

GRIFOS MURALES

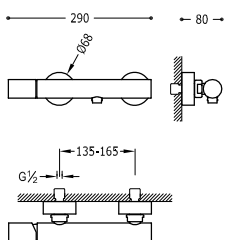

Grifo monomando mural para ducha
 Ducha de mano anticalcárea. Soporte orientable para ducha de mano. Flexo satinado.



- 26116701 **265,00**
- 26116701NM **411,00**
- 26116701BM **411,00**
- 26116701AC **411,00**
- 26116701KM **411,00**
- 26116701KMB **411,00**
- 26116701OR **530,00**
- 26116701OM **530,00**
- 26116701OP **530,00**
- 26116701OPM **530,00**
- 26116701TAM **411,00**
- 26116701TRO **411,00**

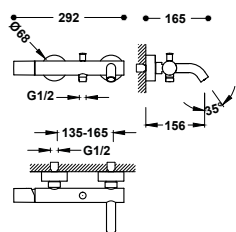

Grifo monomando mural para bañera y ducha

Ducha de mano anticalcárea. Soporte orientable para ducha de mano. Flexo satinado.



	26117001	285,00
	26117001NM	442,00
	26117001BM	442,00
	26117001AC	442,00
	26117001KM	442,00
	26117001KMB	442,00
	26117001OR	570,00
	26117001OM	570,00
	26117001OP	570,00
	26117001OPM	570,00
	26117001TAM	442,00
	26117001TRO	442,00

GRIFOS EMPOTRADOS RAPID-BOX

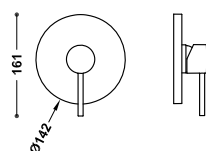

Pieza vista para caja empotrada de 1 vía Rapid-box

Sólo parte vista. Incluye placa embellecedora, mando, casquillo y tornillo de fijación oculto. Caja empotrada no incluida.



	26227810	85,00
	26227810NM	132,00
	26227810BM	132,00
	26227810AC	132,00
	26227810KM	132,00
	26227810KMB	132,00
	26227810OR	170,00
	26227810OM	170,00
	26227810OP	170,00
	26227810OPM	170,00



Caja empotrada de 1 vía Rapid-box con grifo monomando para ducha

20827810 **80,00** N

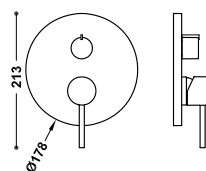

Pieza vista para caja empotrada de 2 vías Rapid-box

Sólo parte vista. Incluye placa embellecedora, mando, volante distribuidor y tornillo de fijación oculto. Caja empotrada no incluida.



	26228110	110,00
	26228110NM	171,00
	26228110BM	171,00
	26228110AC	171,00
	26228110KM	171,00
	26228110KMB	171,00
	26228110OR	220,00
	26228110OM	220,00
	26228110OP	220,00
	26228110OPM	220,00







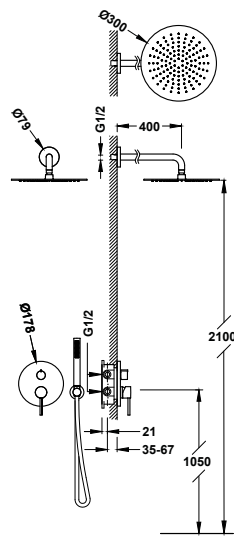



Caja empotrada de 2 vías Rapid-box con grifo monomando para ducha y bañera

20828110 **90,00** N



Kit de grifo monomando empotrado de 2 vías Rapid-box para ducha





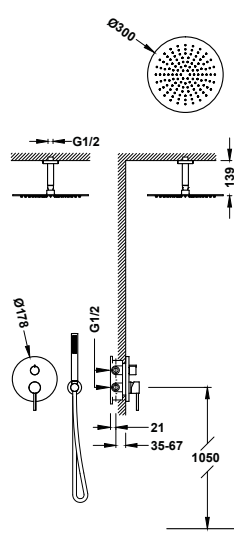





- Cuerpo empotrado incluido.
- Distribuidor cerámico de 2 vías.
- Brazo a pared con rociador de ducha orientable y de acero inoxidable: Ø 300 mm.
- Soporte para ducha de mano con toma de agua a pared.
- Ducha de mano anticalcárea de latón.
- Flexo satinado.

	26228004	476,00
	26228004NM	738,00
	26228004BM	738,00
	26228004AC	738,00
	26228004KM	738,00
	26228004KMB	738,00
	26228004OR	952,00
	26228004OM	952,00
	26228004OP	952,00
	26228004OPM	952,00



Kit de grifo monomando empotrado de 2 vías Rapid-box para ducha





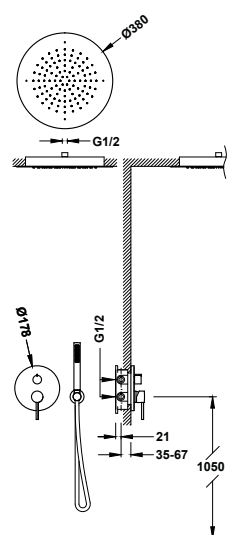





- Cuerpo empotrado incluido.
- Distribuidor cerámico de 2 vías.
- Brazo a techo con rociador de ducha orientable y de acero inoxidable: Ø 300 mm.
- Soporte para ducha de mano con toma de agua a pared.
- Ducha de mano anticalcárea de latón.
- Flexo satinado.

	26228003	451,00
	26228003NM	699,00
	26228003BM	699,00
	26228003AC	699,00
	26228003KM	699,00
	26228003KMB	699,00
	26228003OR	902,00
	26228003OM	902,00
	26228003OP	902,00
	26228003OPM	902,00 



Kit de grifo monomando empotrado de 2 vías Rapid-box para ducha

- Cuerpo empotrado incluido.
- Distribuidor cerámico de 2 vías.
- Rociador de ducha empotrado a techo de acero inoxidable: Ø 380 mm.
- Soporte para ducha de mano con toma de agua a pared.
- Ducha de mano anticalcárea de latón.
- Flexo satinado.

	26228005	1.027,00
	26228005NM	1.592,00
	26228005BM	1.592,00
	26228005AC	1.592,00
	26228005KM	1.592,00
	26228005KMB	1.592,00
	26228005OR	2.054,00
	26228005OM	2.054,00
	26228005OP	2.054,00
	26228005OPM	2.054,00 



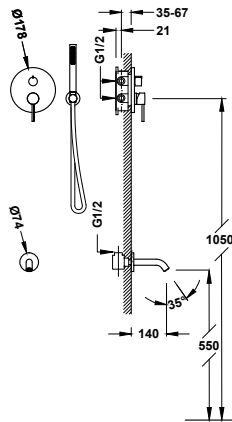

Kit de grifo monomando empotrado de 2 vías Rapid-box para bañera y ducha

- Cuerpo empotrado incluido.
- Distribuidor cerámico de 2 vías.
- Caño fijo de bañera a pared.
- Soporte para ducha de mano con toma de agua a pared.
- Ducha de mano anticalcárea de latón.
- Flexo satinado.

	26228006	366,00
	26228006NM	567,00
	26228006BM	567,00
	26228006AC	567,00
	26228006KM	567,00
	26228006KMB	567,00
	26228006OR	732,00
	26228006OM	732,00
	26228006OP	732,00
	26228006OPM	732,00 N

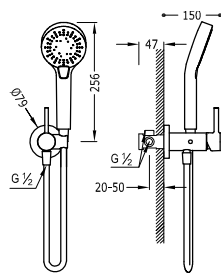

Grifo monomando empotrado de 1 vía para ducha

- Cuerpo empotrado incluido.
- Ducha de mano anticalcárea: Ø 130 mm. (3 tipos de chorro).
- Soporte fijo para la ducha de mano instalable a derecha o izquierda.
- Flexo satinado.

	26212301	178,00
--	----------	---------------



GRIFOS PARA BAÑERA

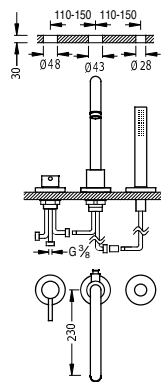

Grifo monomando para borde de bañera

- Inversor integrado en el caño de bañera.
- Ducha de mano anticalcárea de latón.
- Caudal: 3 bar - 14 l/min.
- Kit depósito opcional no incluido ref.: 162245.

	26215001	485,00
--	----------	---------------



Depósito para grifería de borde de bañera

	162245	395,00
--	--------	---------------

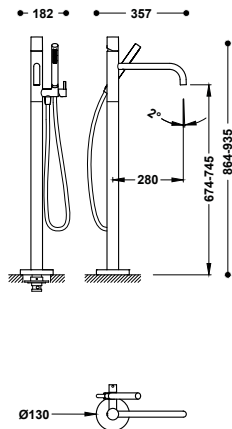

Grifo monomando a suelo para bañera y ducha

1 columna vertical de alimentación de agua a suelo. Soporte para ducha de mano con cierre y regulación de caudal independiente. Ducha de mano anticalcárea de latón. Flexo satinado. Caja empotrada no incluida.

- 26247006 **1.050,00**
- 26247006NM **1.628,00**
- 26247006BM **1.628,00**
- 26247006AC **1.628,00**
- 26247006KM **1.628,00**
- 26247006KMB **1.628,00**
- 26247006OR **2.100,00**
- 26247006OM **2.100,00**
- 26247006OP **2.100,00**
- 26247006OPM **2.100,00**



Base de empotramiento para montaje de grifos monomando a suelo

26285350 **180,00** N

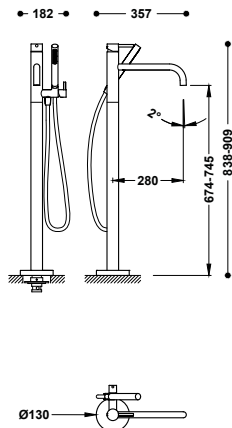

Grifo monomando a suelo para bañera y ducha

1 columna vertical de alimentación de agua a suelo. Soporte para ducha de mano con cierre y regulación de caudal independiente. Ducha de mano anticalcárea de latón. Flexo satinado. Caja empotrada no incluida.

- 26247005 **1.050,00**
- 26247005NM **1.628,00**
- 26247005BM **1.628,00**
- 26247005AC **1.628,00**
- 26247005KM **1.628,00**
- 26247005KMB **1.628,00**
- 26247005OR **2.100,00**
- 26247005OM **2.100,00**
- 26247005OP **2.100,00**
- 26247005OPM **2.100,00**



Base de empotramiento para montaje de grifos monomando a suelo

26285350 **180,00** N



Compra e instala por separado

Puedes instalar la caja empotrada y, posteriormente, adquirir la parte vista para instalarla cuando esté todo listo. De esta manera, la planificación de la obra se simplifica y se gana en eficacia.



Mínima profundidad

El cuerpo empotrado se esconde bajo el suelo y necesita espacio mínimo de 80 mm y uno máximo de 160 mm.

Protección antihumedad

El cuerpo es totalmente estanco, evita las filtraciones de agua y protege contra la humedad.

Fácil de alinear

Una vez instalado el grifo, si no está correctamente alineado, hay la posibilidad de rectificar la orientación del caño en el momento de fijar el grifo.

Cuerpo fácil de nivelar

El cuerpo empotrado se puede nivelar durante la instalación para rectificar las irregularidades del suelo.







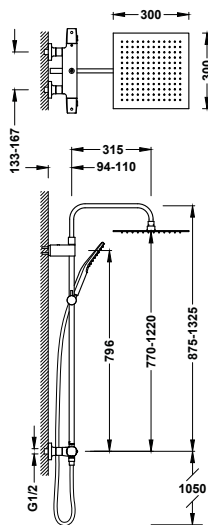

- Ⓐ Dos reguladores independientes, uno para llenar la bañera y el otro para la ducha de mano.
- Ⓑ La temperatura del regulador de la ducha está limitada para evitar quemaduras. (Caudal de 7 l/min).
- Ⓒ La salida para la bañera permite una temperatura más elevada para mantener más agua caliente dentro de la bañera. (Caudal de 22 l/min).
- Ⓓ Soporte de ducha inclinado para evitar el goteo al suelo cuando abrimos o cerramos.

GRIFOS TERMOSTÁTICOS MURALES



Conjunto de grifo termostático mural Over-wall de 2 vías para ducha

- Con inversor integrado en el regulador de caudal.
- Volante con bordes redondeados.
- Barra de ducha telescópica.
- Rociador de ducha orientable de acero inoxidable: 300x300 mm.
- Soporte deslizante y orientable para ducha de mano.
- Ducha de mano anticalcárea: 96x110 mm. (3 tipos de chorro).
- Flexo satinado.

	19038702	592,00
	19038702NM	918,00
	19038702BM	918,00
	19038702AC	918,00
	19038702KMB	918,00
	19038702OM	1.184,00
	19038702OPM	1.184,00





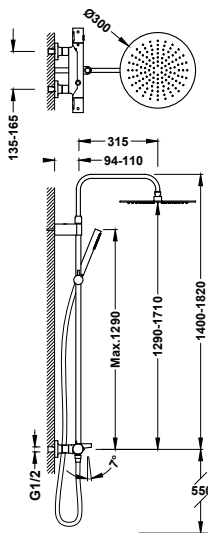



29916834XX



Conjunto de grifo termostático mural Over-wall de 3 vías para bañera y ducha

- Con inversor integrado en el regulador de caudal.
- Volante redondo.
- Barra de ducha telescópica.
- Rociador de ducha orientable de acero inoxidable: Ø 300 mm.
- Soporte deslizante y orientable para ducha de mano.
- Ducha de mano anticalcárea de latón.
- Flexo satinado.

	19031202	603,00
	19031202NM	935,00
	19031202BM	935,00
	19031202AC	935,00
	19031202KMB	935,00
	19031202OM	1.206,00
	19031202OPM	1.206,00







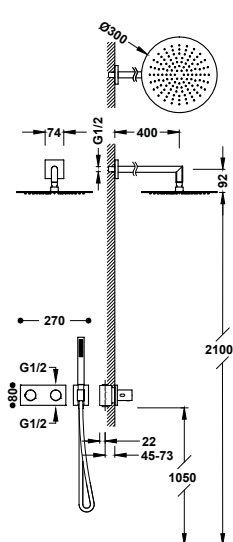

29916832XX

GRIFOS TERMOSTÁTICOS EMPOTRADOS



Kit de grifo termostático empotrado de 2 vías B-system para ducha

- Cuerpo empotrado termostático de instalación horizontal incluido.
- Regulador de caudal y distribuidor cerámico de 2 vías.
- Volante redondo.
- Brazo a pared con rociador de ducha orientable y de acero inoxidable: Ø 300 mm.
- Soporte para ducha de mano con toma de agua a pared.
- Ducha de mano anticalcárea de latón.
- Flexo satinado.

	30735204	803,00
	30735204NM	1.245,00
	30735204AC	1.245,00
	30735204OR	1.606,00
	30735204OM	1.606,00
	30735204OP	1.606,00
	30735204OPM	1.606,00

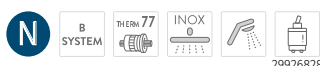

29926828

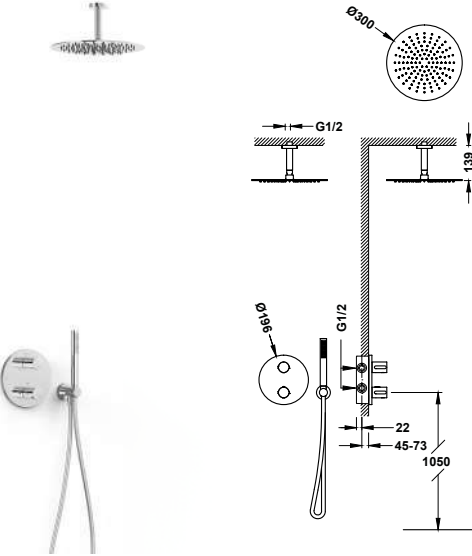

Kit de grifo termostático empotrado de 2 vías Therm-box para ducha

- Cuerpo empotrado incluido.
- Volante redondo con control de temperatura. Distribuidor cerámico de 2 vías.
- Brazo a techo con rociador de ducha orientable y de acero inoxidable: Ø 300 mm.
- Soporte para ducha de mano con toma de agua a pared.
- Ducha de mano anticalcárea de latón.
- Flexo satinado.

26225003	546,00
26225003NM	846,00
26225003BM	846,00
26225003AC	846,00
26225003KM	846,00
26225003KMB	846,00
26225003OR	1.092,00
26225003OM	1.092,00
26225003OP	1.092,00
26225003OPM	1.092,00

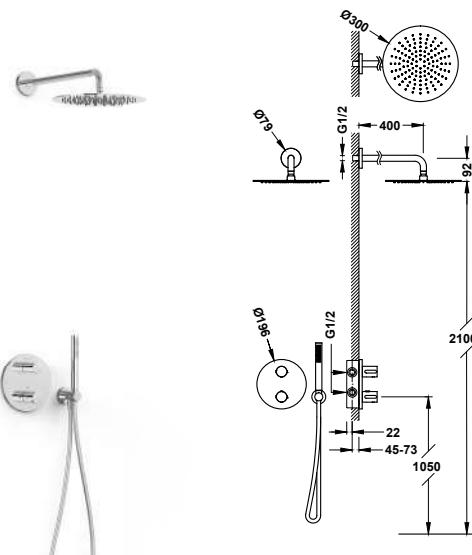

Kit de grifo termostático empotrado de 2 vías Therm-box para ducha

- Cuerpo empotrado incluido.
- Volante redondo con control de temperatura. Distribuidor cerámico de 2 vías.
- Brazo a pared con rociador de ducha orientable y de acero inoxidable: Ø 300 mm.
- Soporte para ducha de mano con toma de agua a pared.
- Ducha de mano anticalcárea de latón.
- Flexo satinado.

26225004	571,00
26225004NM	885,00
26225004BM	885,00
26225004AC	885,00
26225004KM	885,00
26225004KMB	885,00
26225004OR	1.142,00
26225004OM	1.142,00
26225004OP	1.142,00
26225004OPM	1.142,00

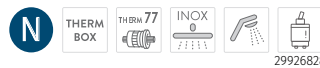

CUADRO

Una colección donde se miman todos los detalles. Con una línea estilizada, cuerpo compacto y de diseño actual, la serie Cuadro es artesanía pura para vestir los espacios más vanguardistas y aportar un toque de distinción.

Acabados disponibles:

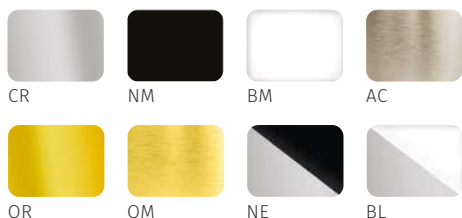





GRIFOS PARA LAVABO

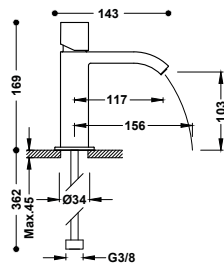

Grifo monomando para lavabo

Caño cerrado con salida del agua en cascada. Caudal limitado a 5 l/min. Latiguillos de alimentación flexibles G3/8. Se incluyen 2 llaves de regulación con filtro (ref: 9134525).

- 00610102 **155,00**
- 00610102D **177,00**

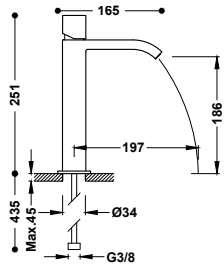

Grifo monomando alto para lavabo

Caño cerrado con salida del agua en cascada. Caudal limitado a 5 l/min. Latiguillos de alimentación flexibles G3/8. Se incluyen 2 llaves de regulación con filtro (ref: 9134525).

- 00661002 **298,00**

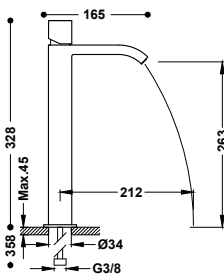

Grifo monomando XXL para lavabo

Caño cerrado con salida del agua en cascada. Caudal limitado a 5 l/min. Latiguillos de alimentación flexibles G3/8. Se incluyen 2 llaves de regulación con filtro (ref: 9134525).

- 00681002 **365,00**

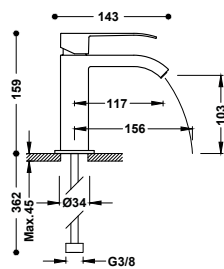

Grifo monomando para lavabo

Caño cerrado con salida del agua en cascada. Caudal limitado a 5 l/min. Latiguillos de alimentación flexibles G3/8. Se incluyen 2 llaves de regulación con filtro (ref: 9134525).

- 00610101 **155,00**
- 00610101D **177,00**
- 00610101NM **240,00**
- 00610101BM **240,00**
- 00610101AC **240,00**
- 00610101OR **310,00**
- 00610101OM **310,00**
- 00610101NE **240,00**
- 00610101BL **240,00**

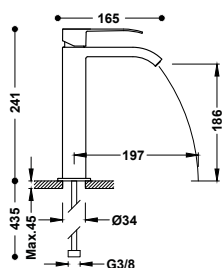

Grifo monomando alto para lavabo

Caño cerrado con salida del agua en cascada. Caudal limitado a 5 l/min. Latiguillos de alimentación flexibles G3/8. Se incluyen 2 llaves de regulación con filtro (ref: 9134525).

- 00661001 **298,00**
- 00661001NM **462,00**
- 00661001BM **462,00**
- 00661001AC **462,00**
- 00661001OR **596,00**
- 00661001OM **596,00**
- 00661001NE **462,00**
- 00661001BL **462,00**





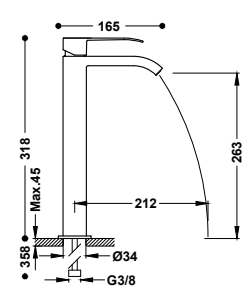





Grifo monomando XXL para lavabo
 Caño cerrado con salida del agua en cascada. Caudal limitado a 5 l/min. Latiguillos de alimentación flexibles G3/8. Se incluyen 2 llaves de regulación con filtro (ref: 9134525).



29919001

	00681001	365,00
	00681001NM	566,00
	00681001BM	566,00
	00681001AC	566,00
	00681001OR	730,00
	00681001OM	730,00
	00681001NE	566,00
	00681001BL	566,00



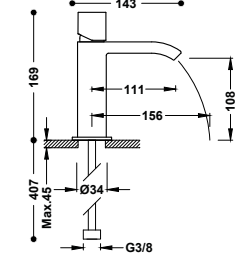





Grifo monomando para lavabo
 Caño abierto con salida del agua en cascada. Latiguillos de alimentación flexibles G3/8. Se incluyen 2 llaves de regulación con filtro (ref: 9134525).



29919002

	00611002	265,00
	00611002D	287,00
	00611002NE	411,00
	00611002BL	411,00



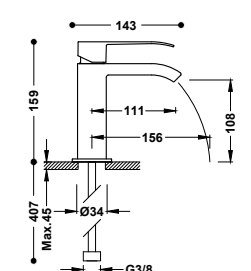





Grifo monomando para lavabo
 Caño abierto con salida del agua en cascada. Latiguillos de alimentación flexibles G3/8. Se incluyen 2 llaves de regulación con filtro (ref: 9134525).



29919002

	00611001	265,00
	00611001D	287,00
	00611001NE	411,00
	00611001BL	411,00



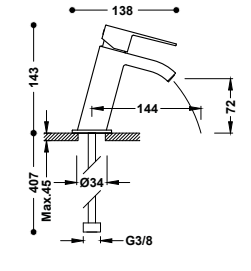







Grifo monomando inclinado para lavabo
 Caño cerrado con salida del agua en cascada. Caudal limitado a 5 l/min. Latiguillos de alimentación flexibles G3/8. Se incluyen 2 llaves de regulación con filtro (ref: 9134525).



29919001

	00620101	162,00
	00620101NM	251,00
	00620101BM	251,00
	00620101AC	251,00
	00620101OR	324,00
	00620101OM	324,00



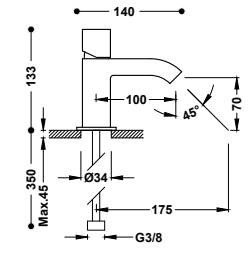



Grifo monomando para lavabo
 Latiguillos de alimentación flexibles G3/8.



9130190

	107103	152,00
	107103DA	174,00

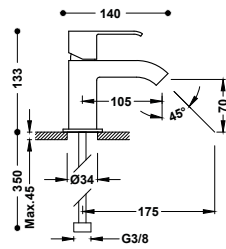

Grifo monomando para lavabo
Latiguillos de alimentación flexibles G3/8.

- 106103 **152,00**
- 106103DA **174,00**

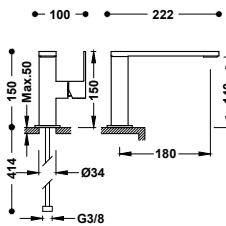

Grifo monomando con maneta lateral para lavabo
Latiguillos de alimentación flexibles G3/8.

- 10620501 **250,00**
- 00620501NM **388,00**
- 00620501BM **388,00**
- 00620501AC **388,00**
- 00620501OR **500,00**
- 00620501OM **500,00**

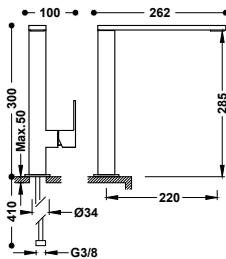

Grifo monomando alto con maneta lateral para lavabo
Latiguillos de alimentación flexibles G3/8.

- 00648501 **290,00**
- 00648501NM **450,00**
- 00648501BM **450,00**
- 00648501AC **450,00**
- 00648501OR **580,00**
- 00648501OM **580,00**

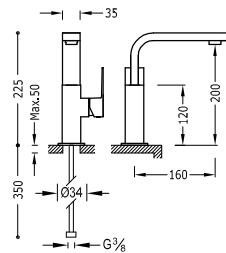

Grifo monomando con maneta lateral para lavabo
Latiguillos de alimentación flexibles G3/8.

- 106603 **222,00**

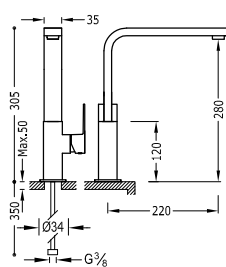

Grifo monomando alto con maneta lateral para lavabo
Latiguillos de alimentación flexibles G3/8.

- 106604 **252,00**



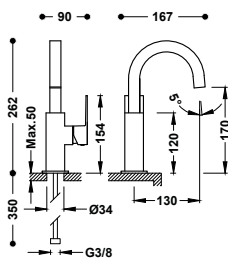

Grifo monomando con maneta lateral para lavabo
 Latiguillos de alimentación flexibles G3/8.



9130190

- 106605 **242,00**
- 00660502NM **375,00**
- 00660502BM **375,00**
- 00660502AC **375,00**
- 00660502OR **484,00**
- 00660502OM **484,00**

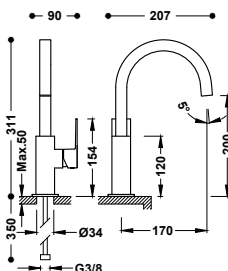

Grifo monomando alto con maneta lateral para lavabo
 Latiguillos de alimentación flexibles G3/8.



9130190

- 106606 **262,00**
- 00660602NM **406,00**
- 00660602BM **406,00**
- 00660602AC **406,00**
- 00660602OR **524,00**
- 00660602OM **524,00**

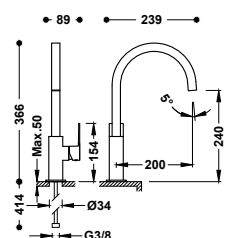

Grifo monomando XXL con maneta lateral para lavabo
 Latiguillos de alimentación flexibles G3/8.



9130190

- 106607 **272,00**
- 00660702NM **422,00**
- 00660702BM **422,00**
- 00660702AC **422,00**
- 00660702OR **544,00**
- 00660702OM **544,00**

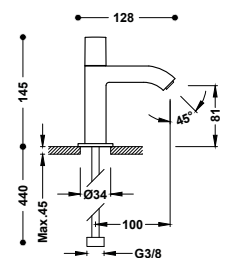

Grifo de 1 agua para lavabo
 Con latiguillo de alimentación flexible G3/8.



910829510

- 107503 **150,00**
- 00750301NM **233,00**
- 00750301BM **233,00**
- 00750301AC **233,00**
- 00750301OR **300,00**
- 00750301OM **300,00**

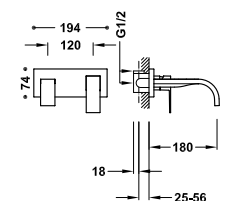

Grifo monomando empotrado para lavabo
 Cuerpo empotrado indivisible con amortiguadores acústicos. Junta antihumedad. Caño de 180 mm.



29902801

- 00630011 **275,00**
- 00630011NM **426,00**
- 00630011BM **426,00**
- 00630011AC **426,00**
- 00630011OR **550,00**
- 00630011OM **550,00**

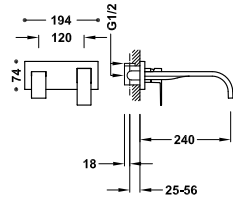

Grifo monomando empotrado para lavabo

Cuerpo empotrado indivisible con amortiguadores acústicos. Junta antihumedad. Caño de 240 mm.



- 00630012 **285,00**
- 00630012NM **442,00**
- 00630012BM **442,00**
- 00630012AC **442,00**
- 00630012OR **570,00**
- 00630012OM **570,00**

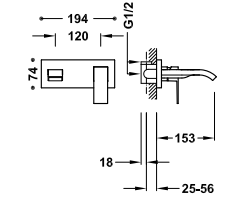

Grifo monomando empotrado para lavabo

Cuerpo empotrado indivisible con amortiguadores acústicos. Junta antihumedad. Caño de 153 mm. Caño cerrado, salida del agua en cascada.



- 00630013 **325,00**
- 00630013NM **504,00**
- 00630013BM **504,00**
- 00630013AC **504,00**
- 00630013OR **650,00**
- 00630013OM **650,00**

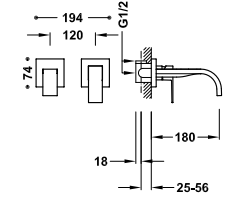

Grifo monomando empotrado para lavabo

Cuerpo empotrado indivisible con amortiguadores acústicos. Junta antihumedad. Caño de 180 mm.



- 00630001 **242,00**
- 00630001NM **375,00**
- 00630001BM **375,00**
- 00630001AC **375,00**
- 00630001OR **484,00**
- 00630001OM **484,00**

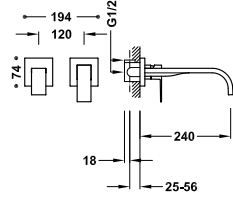

Grifo monomando empotrado para lavabo

Cuerpo empotrado indivisible con amortiguadores acústicos. Junta antihumedad. Caño de 240 mm.



- 00630002 **252,00**
- 00630002NM **391,00**
- 00630002BM **391,00**
- 00630002AC **391,00**
- 00630002OR **504,00**
- 00630002OM **504,00**

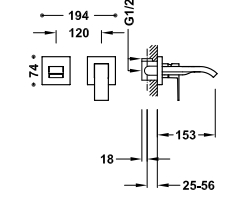

Grifo monomando empotrado para lavabo

Cuerpo empotrado indivisible con amortiguadores acústicos. Junta antihumedad. Caño de 153 mm. Caño cerrado, salida del agua en cascada.



- 00630003 **295,00**
- 00630003NM **457,00**
- 00630003BM **457,00**
- 00630003AC **457,00**
- 00630003OR **590,00**
- 00630003OM **590,00**

GRIFOS PARA BIDÉ

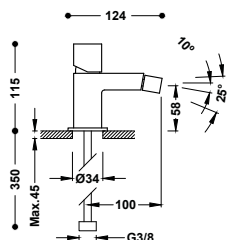

Grifo monomando para bidé
Rótula orientable. Latiguillos de alimentación flexibles G3/8.



- 00712001 **158,00**
- 00712001D **180,00**
- 00712001NM **245,00**
- 00712001BM **245,00**
- 00712001AC **245,00**
- 00712001OR **316,00**
- 00712001OM **316,00**
- 00712001NE **245,00**
- 00712001BL **245,00**

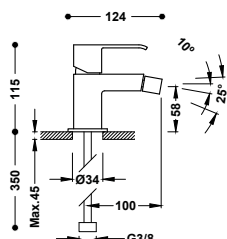

Grifo monomando para bidé
Rótula orientable. Latiguillos de alimentación flexibles G3/8.



- 00612001 **158,00**
- 00612001D **180,00**
- 00612001NM **245,00**
- 00612001BM **245,00**
- 00612001AC **245,00**
- 00612001OR **316,00**
- 00612001OM **316,00**
- 00612001NE **245,00**
- 00612001BL **245,00**

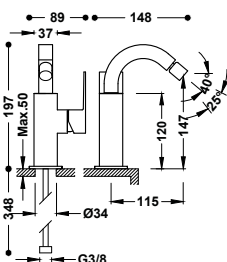

Grifo monomando con maneta lateral para bidé
Rótula orientable. Latiguillos de alimentación flexibles G3/8.



- 106124 **222,00**
- 00612402NM **344,00**
- 00612402BM **344,00**
- 00612402AC **344,00**
- 00612402OR **444,00**
- 00612402OM **444,00**

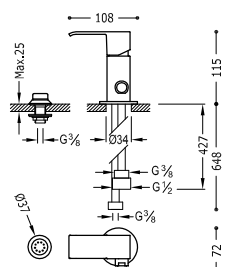

Grifo monomando para bidé con transferencia a duchita
Latiguillos de alimentación flexibles G3/8.



- 00613001 **135,00**
- 00613001NM **209,00**
- 00613001BM **209,00**
- 00613001AC **209,00**
- 00613001OR **270,00**
- 00613001OM **270,00**

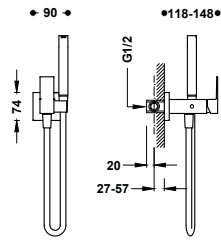

Grifo monomando empotrado con ducha para inodoro
 Con agua fría o caliente. Ducha de mano con racor limitador a 5 l/min. y sistema antigoteo. Soporte fijo para la ducha de mano instalable a derecha o izquierda. Flexo satinado.



- 00612301 **190,00**
- 00612301NM **295,00**
- 00612301BM **295,00**
- 00612301AC **295,00**
- 00612301OR **380,00** N
- 00612301OM **380,00** N

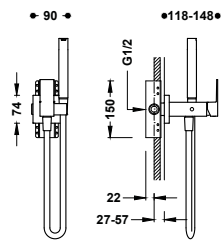

Grifo monomando empotrado con ducha para inodoro
 Opción para paredes de Pladur. Con agua fría o caliente. Ducha de mano con racor limitador a 5 l/min. y sistema antigoteo. Soporte fijo para la ducha de mano instalable a derecha o izquierda. Flexo satinado.



- 00612302 **230,00**
- 00612302NM **357,00**
- 00612302BM **357,00**
- 00612302AC **357,00**



Accesorio porta toallas para grifo con ducha para inodoro
 Soporte instalable a derecha o izquierda (para ref.: 00612301, 00612302). Long: 180 mm.

- 03412402 **45,00**
- 03412402NM **69,75**
- 03412402BM **69,75**
- 03412402AC **69,75**
- 03412402OR **90,00** N
- 03412402OM **90,00** N

GRIFOS MURALES

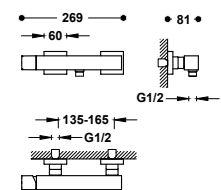

Grifo monomando mural para ducha
 Ducha de mano anticalcárea de latón. Soporte orientable para ducha de mano. Flexo satinado.



- 107167 **298,00**
- 00716703NM **462,00**
- 00716703BM **462,00**
- 50716703 **462,00**
- 00716703OR **596,00**
- 00716703OM **596,00**

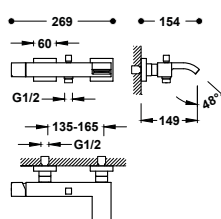

Grifo monomando mural para bañera y ducha
 Con salida de agua en cascada. Ducha de mano anticalcárea de latón. Soporte orientable para ducha de mano. Flexo satinado.



- 10717002 **318,00**
- 0071700203NM **493,00**
- 0071700203BM **493,00**
- 5071700203 **493,00**
- 0071700203OR **636,00**
- 0071700203OM **636,00**

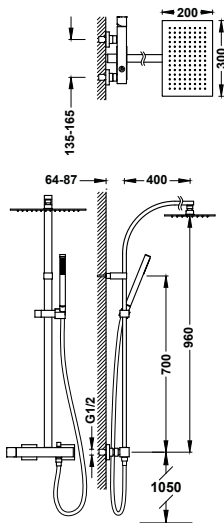

Conjunto de grifo monomando mural de 2 vías para ducha

00719102

667,00

- Rociador de ducha orientable de acero inoxidable: 300x200 mm.
- Soporte deslizante y orientable para ducha de mano.
- Ducha de mano anticalcárea de latón.
- Flexo satinado.

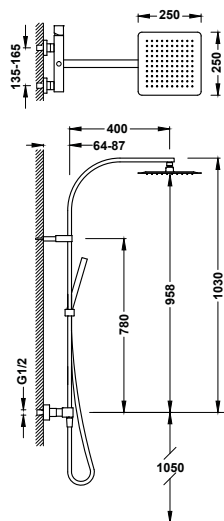

Conjunto de grifo monomando mural de 2 vías para ducha

00719101

633,00

- Rociador de ducha orientable de acero inoxidable: 250x250 mm.
- Soporte deslizante y orientable para ducha de mano.
- Ducha de mano anticalcárea de latón.
- Flexo satinado.

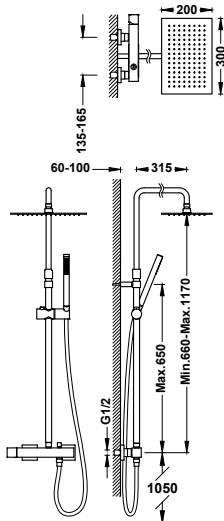

Conjunto de grifo monomando mural de 2 vías para ducha

00719702

616,00

- Rociador de ducha orientable de acero inoxidable: 300x200 mm.
- Barra de ducha telescópica.
- Soporte deslizante y orientable para ducha de mano.
- Ducha de mano anticalcárea de latón.
- Flexo satinado.



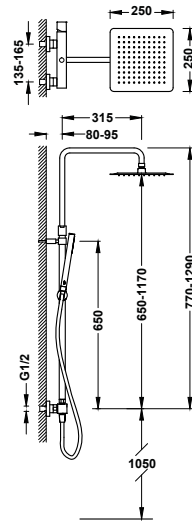

Conjunto de grifo monomando mural de 2 vías para ducha

00719701

585,00

- Rociador de ducha orientable de acero inoxidable: 250x250 mm.
- Barra de ducha telescópica.
- Soporte deslizante y orientable para ducha de mano.
- Ducha de mano anticalcárea de latón.
- Flexo satinado.



GRIFOS EMPOTRADOS RAPID-BOX

Pieza vista para caja empotrada de 1 vía Rapid-box

10627810

85,00

Sólo parte vista. Incluye placa embellecedora, mando, casquillo y tornillo de fijación oculto. **Caja empotrada no incluida.**

- 10627810NM 132,00
- 10627810BM 132,00
- 10627810AC 132,00
- 10627810OR 170,00
- 10627810OM 170,00

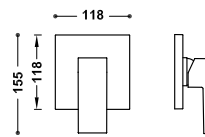

Caja empotrada de 1 vía Rapid-box con grifo monomando para ducha

20827810

80,00 N



Pieza vista para caja empotrada de 2 vías Rapid-box

10628110

110,00

Sólo parte vista. Incluye placa embellecedora, mando, volante distribuidor y tornillo de fijación oculto. **Caja empotrada no incluida.**

- 10628110NM 171,00
- 10628110BM 171,00
- 10628110AC 171,00
- 10628110OR 220,00
- 10628110OM 220,00

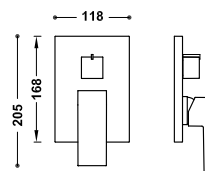

Caja empotrada de 2 vías Rapid-box con grifo monomando para ducha y bañera

20828110

90,00 N



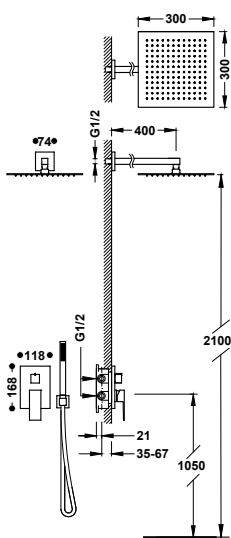

Kit de grifo monomando empotrado de 2 vías Rapid-box para ducha

- Cuerpo empotrado incluido.
- Distribuidor cerámico de 2 vías.
- Brazo a pared con rociador de ducha orientable y de acero inoxidable: 300x300 mm.
- Soporte para ducha de mano con toma de agua a pared.
- Ducha de mano anticalcárea de latón.
- Flexo satinado.

	00628004	564,00
	00628004NM	874,00
	00628004BM	874,00
	00628004AC	874,00
	00628004OR	1.128,00
	00628004OM	1.128,00



29903508

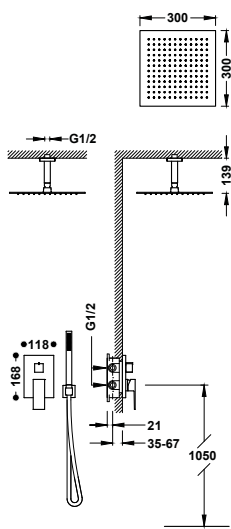

Kit de grifo monomando empotrado de 2 vías Rapid-box para ducha

- Cuerpo empotrado incluido.
- Distribuidor cerámico de 2 vías.
- Brazo a techo con rociador de ducha orientable y de acero inoxidable: 300x300 mm.
- Soporte para ducha de mano con toma de agua a pared.
- Ducha de mano anticalcárea de latón.
- Flexo satinado.

	00628003	542,00
	00628003NM	840,00
	00628003BM	840,00
	00628003AC	840,00
	00628003OR	1.084,00
	00628003OM	1.084,00



29903508

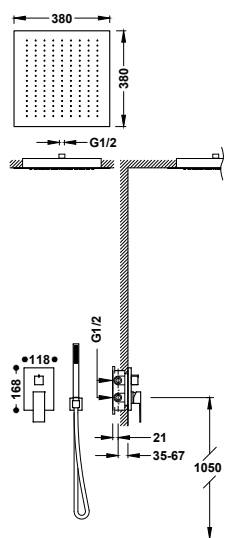

Kit de grifo monomando empotrado de 2 vías Rapid-box para ducha

- Cuerpo empotrado incluido.
- Distribuidor cerámico de 2 vías.
- Rociador de ducha empotrado a techo de acero inoxidable: 380x380 mm.
- Soporte para ducha de mano con toma de agua a pared.
- Ducha de mano anticalcárea de latón.
- Flexo satinado.

	00628005	1.077,00
	00628005NM	1.669,00
	00628005BM	1.669,00
	00628005AC	1.669,00
	00628005OR	2.154,00
	00628005OM	2.154,00



29903508

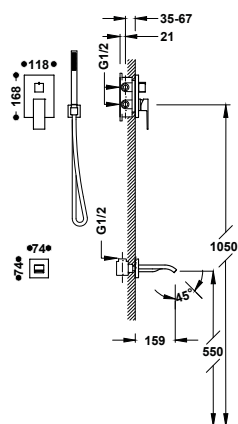

Kit de grifo monomando empotrado de 2 vías Rapid-box para bañera y ducha

- Cuerpo empotrado incluido.
- Distribuidor cerámico de 2 vías.
- Caño fijo de bañera a pared.
- Soporte para ducha de mano con toma de agua a pared.
- Ducha de mano anticalcárea de latón.
- Flexo satinado.

	00628006	469,00
	00628006NM	727,00
	00628006BM	727,00
	00628006AC	727,00
	00628006OR	938,00
	00628006OM	938,00



GRIFOS EMPOTRADOS

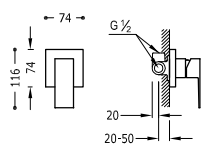

Grifo monomando empotrado de 1 vía para ducha

Cuerpo empotrado incluido.

	106177	120,00
--	--------	---------------



Alargadera para grifo monomando empotrado de 1 vía para ducha

	10617710	90,00
--	----------	--------------

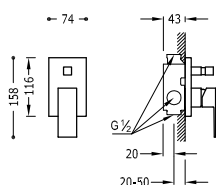

Grifo monomando empotrado de 2 vías para bañera y ducha

Cuerpo empotrado incluido. Inversor de 2 vías.

	106180	200,00
--	--------	---------------



Set de prolongación para los grifos monomando empotrado de 2 vías

	10618010	124,00
--	----------	---------------

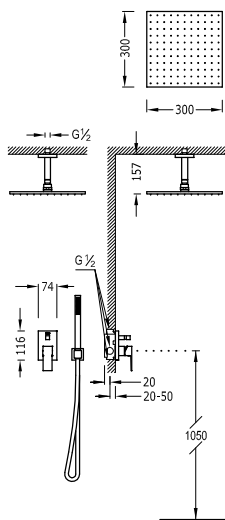

Kit de grifo monomando empotrado de 2 vías para ducha

00618080

542,00

- Cuerpo empotrado incluido.
- Inversor de 2 vías.
- Brazo a techo con rociador de ducha orientable y de acero inoxidable: 300x300 mm.
- Soporte para ducha de mano con toma de agua a pared.
- Ducha de mano anticalcárea de latón.
- Flexo satinado.

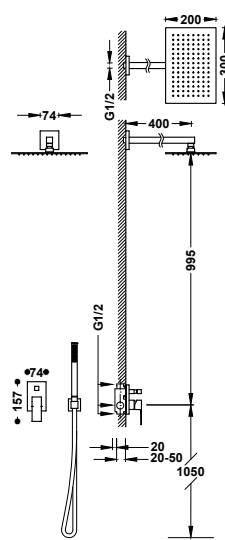

Kit de grifo monomando empotrado de 2 vías para ducha

00698003

596,00

- Cuerpo empotrado incluido.
- Inversor de 2 vías.
- Brazo a pared con rociador de ducha orientable y de acero inoxidable: 300x200 mm.
- Soporte para ducha de mano con toma de agua a pared.
- Ducha de mano anticalcárea de latón.
- Flexo satinado.

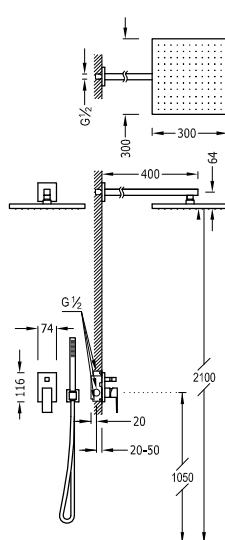

Kit de grifo monomando empotrado de 2 vías para ducha

106980

564,00

- Cuerpo empotrado incluido.
- Inversor de 2 vías.
- Brazo a pared con rociador de ducha orientable y de acero inoxidable: 300x300 mm.
- Soporte para ducha de mano con toma de agua a pared.
- Ducha de mano anticalcárea de latón.
- Flexo satinado.



GRIFOS PARA BAÑERA

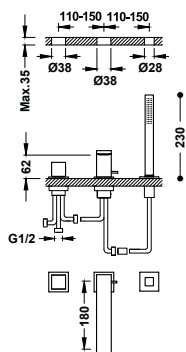

Grifo monomando para borde de bañera

- Inversor integrado en el caño de bañera.
- Ducha de mano anticalcárea de latón.
- Caño de bañera de 180 mm. Caudal: 3 bar - 13 l/min.
- Kit depósito opcional no incluido ref.: 20024501.

00616106

440,00



Depósito para grifería de borde de bañera

20024501

395,00

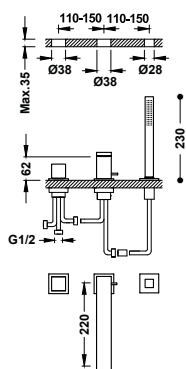

Grifo monomando para borde de bañera

- Inversor integrado en el caño de bañera.
- Ducha de mano anticalcárea de latón.
- Caño de bañera de 220 mm. Caudal: 3 bar - 13 l/min.
- Kit depósito opcional no incluido ref.: 20024501.

00616104

450,00



Depósito para grifería de borde de bañera

20024501

395,00

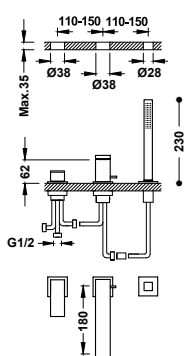

Grifo monomando para borde de bañera

- Inversor integrado en el caño de bañera.
- Ducha de mano anticalcárea de latón.
- Caño de bañera de 180 mm. Caudal: 3 bar - 13 l/m.
- Kit depósito opcional no incluido ref.: 20024501.

00616105

440,00

- 00616105NM 682,00
- 00616105BM 682,00
- 00616105AC 682,00
- 00616105OR 880,00
- 00616105OM 880,00



Depósito para grifería de borde de bañera





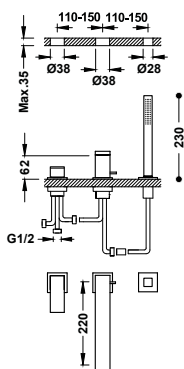

20024501

395,00



Grifo monomando para borde de bañera

- Inversor integrado en el caño de bañera.
- Ducha de mano anticalcárea de latón.
- Caño de bañera de 220 mm. Caudal: 3 bar - 13 l/m.
- Kit depósito opcional no incluido ref.: 20024501.

	00616103	450,00
	00616103NM	698,00
	00616103BM	698,00
	00616103AC	698,00
	00616103OR	900,00
	00616103OM	900,00



Depósito para grifería de borde de bañera

	20024501	395,00
---	----------	---------------

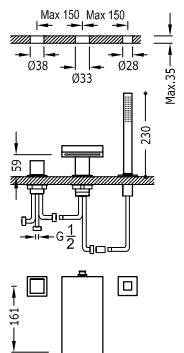

Grifo monomando para borde de bañera

- Inversor integrado en el caño de bañera.
- Ducha de mano anticalcárea de latón.
- Caño de bañera con salida del agua en cascada: 164 mm. Caudal: 3 bar -13 l/min.
- Kit depósito opcional no incluido ref.: 106245.

	10716102	980,00
---	----------	---------------



Depósito para grifería de borde de bañera

	106245	395,00
---	--------	---------------

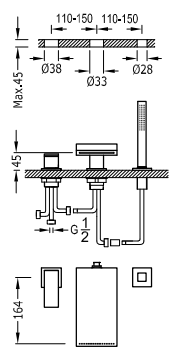

Grifo monomando para borde de bañera

- Inversor integrado en el caño de bañera.
- Ducha de mano anticalcárea de latón.
- Caño de bañera con salida del agua en cascada: 164 mm. Caudal: 3 bar -13 l/min.
- Kit depósito opcional no incluido ref.: 106245.

	10616102	990,00
---	----------	---------------



Depósito para grifería de borde de bañera

	106245	395,00
---	--------	---------------

GRIFOS TERMOSTÁTICOS MURALES

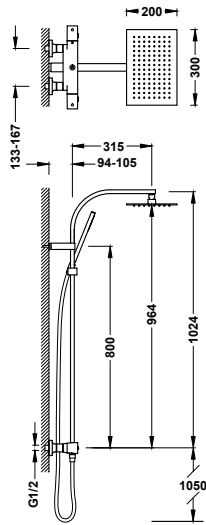

Conjunto de grifo termostático mural Over-wall de 2 vías para ducha

- Con inversor integrado en el regulador de caudal.
- Volante cuadrado.
- Rociador de ducha orientable de acero inoxidable: 300x200 mm.
- Soporte deslizante y orientable para ducha de mano.
- Ducha de mano anticalcárea de latón.
- Flexo satinado.

19039306	691,00
19039306NM	1.071,00
19039306BM	1.071,00
19039306AC	1.071,00
19039306OM	1.382,00



GRIFOS TERMOSTÁTICOS EMPOTRADOS

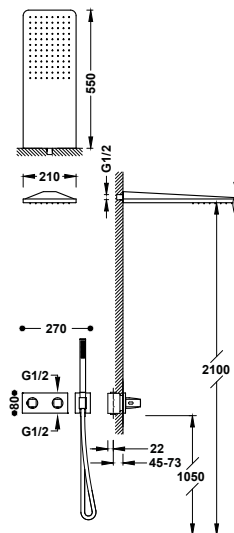

Kit de grifo termostático empotrado de 2 vías B-system para ducha

- Cuerpo empotrado termostático de instalación horizontal incluido.
- Regulador de caudal y distribuidor cerámico de 2 vías.
- Volante cuadrado-redondo.
- Rociador de ducha a pared de acero inoxidable: 210x550 mm.
- Soporte para ducha de mano con toma de agua a pared.
- Ducha de mano anticalcárea de latón.
- Flexo satinado.

30725205	1.187,00
30725205NM	1.840,00
30725205AC	1.840,00
30725205OR	2.374,00
30725205OM	2.374,00



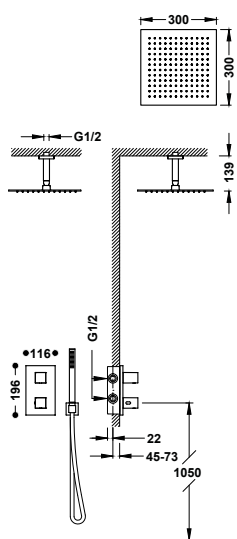

Kit de grifo termostático empotrado de 2 vías Therm-box para ducha

- Cuerpo empotrado incluido.
- Volante cuadrado con control de temperatura. Distribuidor cerámico de 2 vías.
- Brazo a techo con rociador de ducha orientable y de acero inoxidable: 300x300 mm.
- Soporte para ducha de mano con toma de agua a pared.
- Ducha de mano anticalcárea de latón.
- Flexo satinado.

	00625003	603,00
	00625003NM	935,00
	00625003BM	935,00
	00625003AC	935,00
	00625003OR	1.206,00
	00625003OM	1.206,00

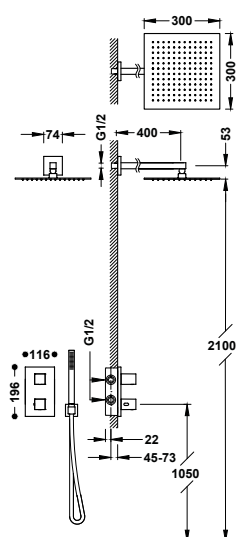

Kit de grifo termostático empotrado de 2 vías Therm-box para ducha

- Cuerpo empotrado incluido.
- Volante cuadrado con control de temperatura. Distribuidor cerámico de 2 vías.
- Brazo a pared con rociador de ducha orientable y de acero inoxidable: 300x300 mm.
- Soporte para ducha de mano con toma de agua a pared.
- Ducha de mano anticalcárea de latón.
- Flexo satinado.







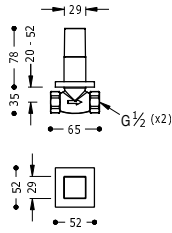



	00625004	624,00
	00625004NM	967,00
	00625004BM	967,00
	00625004AC	967,00
	00625004OR	1.248,00
	00625004OM	1.248,00



LLAVES DE PASO



Llave de paso empotrada
Conexión a rosca hembra: 1/2".

	00715501	85,00
	00715501NM	132,00 
	00715501BM	132,00 
	00715501AC	132,00 
	00715501OR	170,00 
	00715501OM	170,00 

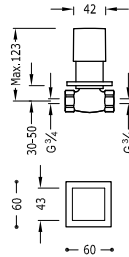

Llave de paso empotrada
Conexión a rosca hembra: 3/4".

	107511	93,00
---	--------	--------------



LOFT

El equilibrio entre las superficies planas y las redondeadas dan como resultado una colección muy amplia y versátil. Loft es la serie que mejor encaja y siempre acierta. Diseñada para el agua.

Acabados disponibles:

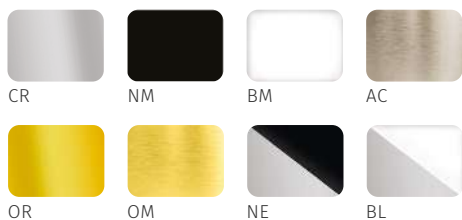





GRIFOS PARA LAVABO

Grifo monomando para lavabo

Latiguillos de alimentación flexibles G3/8.

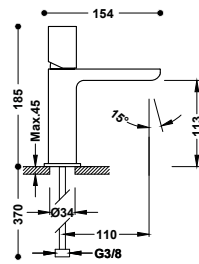

-  20010302 **125,00**
-   20010302D **147,00**
-  20010302NM **194,00**
-  20010302BM **194,00**
-  20010302AC **194,00**
-  20010302OR **250,00**
-  20010302OM **250,00**
-  20010302NE **194,00**
-  20010302BL **194,00**



9130190

Grifo monomando para lavabo

Caño cerrado con salida del agua en cascada. Latiguillos de alimentación flexibles G3/8. Se incluyen 2 llaves de regulación con filtro (ref: 9134525).

-  20010102 **150,00**
-   20010102D **172,00**

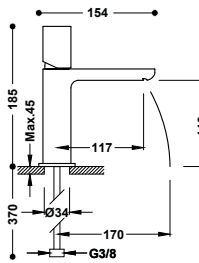

9130190

Grifo monomando alto para lavabo

Latiguillos de alimentación flexibles G3/8.

-  20020304 **232,00**
-  20020304NM **360,00**
-  20020304BM **360,00**
-  20020304AC **360,00**
-  20020304OR **464,00**
-  20020304OM **464,00**
-  20020304NE **360,00**
-  20020304BL **360,00**

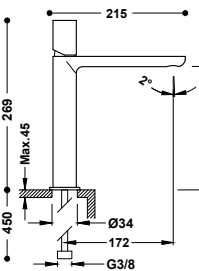

9130190

Grifo monomando XXL para lavabo

Latiguillos de alimentación flexibles G3/8.

-  20020306 **265,00**
-  20020306NM **411,00**
-  20020306BM **411,00**
-  20020306AC **411,00**
-  20020306OR **530,00**
-  20020306OM **530,00**
-  20020306NE **411,00**
-  20020306BL **411,00**

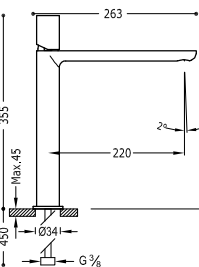

9130190

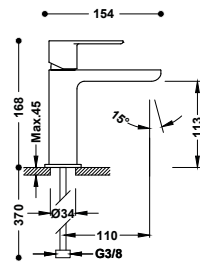

Grifo monomando para lavabo
Latiguillos de alimentación flexibles G3/8.



- 20010301 **125,00**
- 20010301D **147,00**
- 20010301NM **194,00**
- 20010301BM **194,00**
- 20010301AC **194,00**
- 20010301OR **250,00**
- 20010301OM **250,00**
- 20010301NE **194,00**
- 20010301BL **194,00**

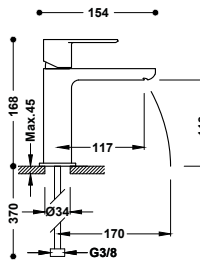

Grifo monomando para lavabo
Caño cerrado con salida del agua en cascada. Latiguillos de alimentación flexibles G3/8. Se incluyen 2 llaves de regulación con filtro (ref: 9134525).



- 20010101 **150,00**
- 20010101D **172,00**

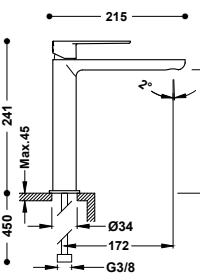

Grifo monomando alto para lavabo
Latiguillos de alimentación flexibles G3/8.



- 20020303 **232,00**
- 20020303NM **360,00**
- 20020303BM **360,00**
- 20020303AC **360,00**
- 20020303OR **464,00**
- 20020303OM **464,00**
- 20020303NE **360,00**
- 20020303BL **360,00**

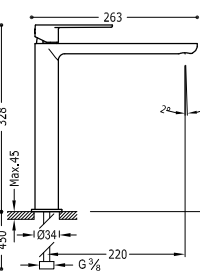

Grifo monomando XXL para lavabo
Latiguillos de alimentación flexibles G3/8.



- 20020305 **265,00**
- 20020305NM **411,00**
- 20020305BM **411,00**
- 20020305AC **411,00**
- 20020305OR **530,00**
- 20020305OM **530,00**
- 20020305NE **411,00**
- 20020305BL **411,00**

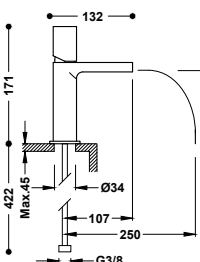



Grifo monomando para lavabo
Caño abierto con salida del agua en cascada. Latiguillos de alimentación flexibles G3/8. Se incluyen 2 llaves de regulación con filtro (ref: 9134525).



- 20011002 **212,00**
- 20011002NE **329,00**
- 20011002BL **329,00**

Grifo monomando para lavabo

Caño abierto con salida del agua en cascada. Latiguillos de alimentación flexibles G3/8. Se incluyen 2 llaves de regulación con filtro (ref: 9134525).

-  20011001 **212,00**
-  20011001NE **329,00**
-  20011001BL **329,00**

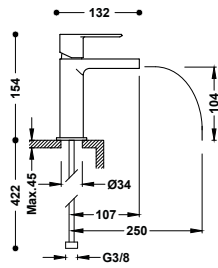

9130190

Grifo monomando con maneta lateral para lavabo

Latiguillos de alimentación flexibles G3/8.



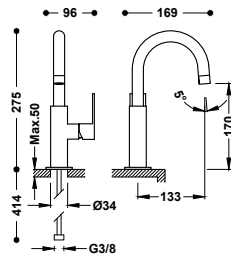

-  20020504 **200,00**
-  20020504NM **310,00**
-  20020504BM **310,00**
-  20020504AC **310,00**
-  20020504OR **400,00**
-  20020504OM **400,00**
-  20020504NE **310,00**
-  20020504BL **310,00**



9130190

Grifo monomando alto con maneta lateral para lavabo

Latiguillos de alimentación flexibles G3/8.



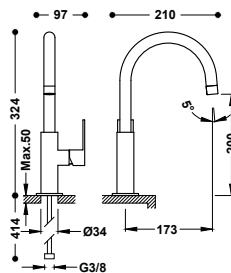

-  20020505 **210,00**
-  20020505NM **326,00**
-  20020505BM **326,00**
-  20020505AC **326,00**
-  20020505OR **420,00**
-  20020505OM **420,00**
-  20020505NE **326,00**
-  20020505BL **326,00**



9130190

Grifo monomando XXL con maneta lateral para lavabo

Latiguillos de alimentación flexibles G3/8.

-  20020506 **220,00**
-  20020506NM **341,00**
-  20020506BM **341,00**
-  20020506AC **341,00**
-  20020506OR **440,00**
-  20020506OM **440,00**
-  20020506NE **341,00**
-  20020506BL **341,00**

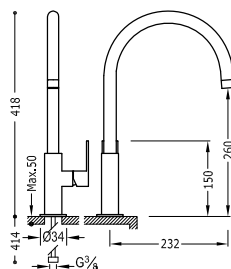

9130190

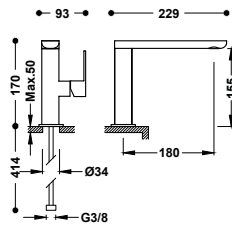

Grifo monomando con maneta lateral para lavabo
Latiguillos de alimentación flexibles G3/8.



- 20020501 **185,00**
- 20020501NM **287,00**
- 20020501BM **287,00**
- 20020501AC **287,00**
- 20020501OR **370,00**
- 20020501OM **370,00**
- 20020501NE **287,00**
- 20020501BL **287,00**

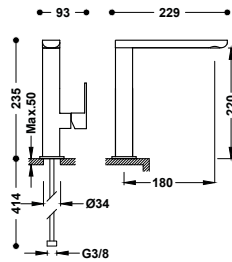

Grifo monomando alto con maneta lateral para lavabo
Latiguillos de alimentación flexibles G3/8.

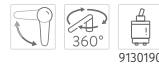

- 20020502 **205,00**
- 20020502NM **318,00**
- 20020502BM **318,00**
- 20020502AC **318,00**
- 20020502OR **410,00**
- 20020502OM **410,00**
- 20020502NE **318,00**
- 20020502BL **318,00**

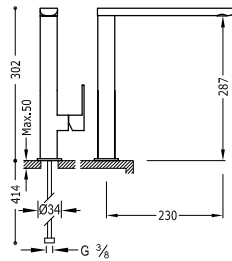

Grifo monomando XXL con maneta lateral para lavabo
Latiguillos de alimentación flexibles G3/8.



- 20020503 **225,00**
- 20020503NM **349,00**
- 20020503BM **349,00**
- 20020503AC **349,00**
- 20020503OR **450,00**
- 20020503OM **450,00**
- 20020503NE **349,00**
- 20020503BL **349,00**

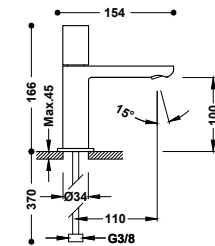

Grifo de 1 agua para lavabo
Con latiguillo de alimentación flexible G3/8.



- 20050301 **95,00**
- 20050301NM **147,00**
- 20050301BM **147,00**
- 20050301AC **147,00**
- 20050301OR **190,00**
- 20050301OM **190,00**

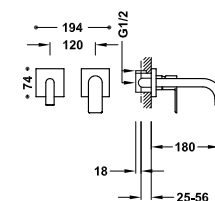

Grifo monomando empotrado para lavabo
Cuerpo empotrado indivisible con amortiguadores acústicos. Junta antihumedad. Caño de 180 mm.



- 20030001 **235,00**
- 20030001NM **364,00**
- 20030001BM **364,00**
- 20030001AC **364,00**
- 20030001OR **470,00**
- 20030001OM **470,00**

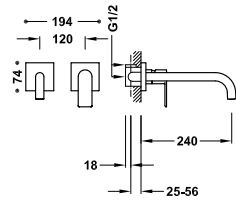

Grifo monomando empotrado para lavabo

Cuerpo empotrado indivisible con amortiguadores acústicos. Junta antihumedad. Caño de 240 mm.



	20030002	245,00
	20030002NM	380,00
	20030002BM	380,00
	20030002AC	380,00
	20030002OR	490,00
	20030002OM	490,00

GRIFOS PARA BIDÉ

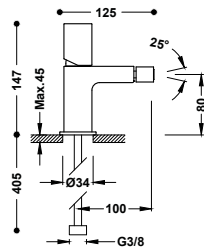

Grifo monomando para bidé

Rótula orientable. Latiguillos de alimentación flexibles G3/8.

	20012002	128,00
	20012002D	150,00
	20012002NM	198,00
	20012002BM	198,00
	20012002AC	198,00
	20012002OR	256,00
	20012002OM	256,00
	20012002NE	198,00
	20012002BL	198,00

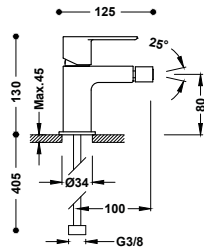

Grifo monomando para bidé

Rótula orientable. Latiguillos de alimentación flexibles G3/8.

	20012001	128,00
	20012001D	150,00
	20012001NM	198,00
	20012001BM	198,00
	20012001AC	198,00
	20012001OR	256,00
	20012001OM	256,00
	20012001NE	198,00
	20012001BL	198,00

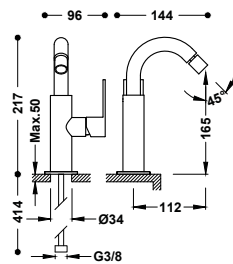

Grifo monomando con maneta lateral para bidé

Rótula orientable. Latiguillos de alimentación flexibles G3/8.

	20022401	192,00
	20022401NM	298,00
	20022401BM	298,00
	20022401AC	298,00
	20022401OR	384,00
	20022401OM	384,00
	20022401NE	298,00
	20022401BL	298,00

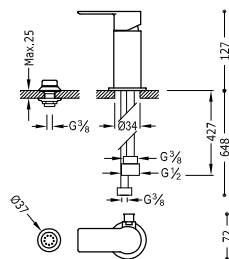

Grifo monomando para bidé con transferencia a duchita

Con inversor para duchita. Latiguillos de alimentación flexibles G3/8.

	20013001	135,00
	20013001NM	209,00
	20013001BM	209,00
	20013001AC	209,00
	20013001KM	209,00
	20013001KMB	209,00
	20013001OR	270,00
	20013001OM	270,00
	20013001OP	270,00
	20013001OPM	270,00

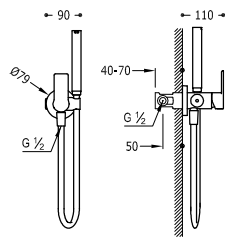

Grifo monomando empotrado con ducha para inodoro

Con agua fría o caliente. Ducha de mano con racor limitador a 5 l/min. y sistema antigoteo. Soporte fijo para la ducha de mano instalable a derecha o izquierda. Flexo satinado.



- 20522301 **180,00**
- 20522301NM **279,00**
- 20522301BM **279,00**
- 20522301AC **279,00**
- 20522301OR **360,00**
- 20522301OM **360,00**

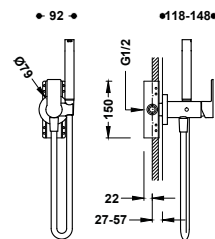

Grifo monomando empotrado con ducha para inodoro

Opción para paredes de Pladur. Con agua fría o caliente. Ducha de mano con racor limitador a 5 l/min. y sistema antigoteo. Soporte fijo para la ducha de mano instalable a derecha o izquierda. Flexo satinado.



- 20522201 **220,00**
- 20522201NM **341,00**
- 20522201BM **341,00**
- 20522201AC **341,00**



Accesorio porta toallas para grifo con ducha para inodoro

Soporte instalable a derecha o izquierda (para ref.: 134122, 134123, 181122, 181123, 181222, 181223, 20522201, 20522301). Long: 180 mm.

- 03412401 **35,00**
- 03412401NM **54,25**
- 03412401BM **54,25**
- 03412401AC **54,25**
- 03412401OR **70,00**
- 03412401OM **70,00**

GRIFOS MURALES

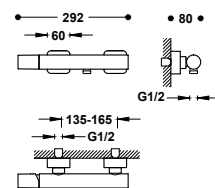

Grifo monomando mural para ducha

Ducha de mano anticalcárea. Soporte orientable para ducha de mano. Flexo satinado.



- 20016701 **235,00**
- 20016701NM **364,00**
- 20016701BM **364,00**
- 20016701AC **364,00**
- 20016701OR **470,00**
- 20016701OM **470,00**

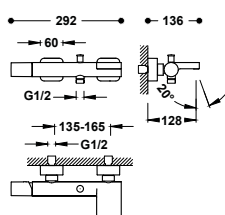

Grifo monomando mural para bañera y ducha

Ducha de mano anticalcárea. Con salida de agua en cascada. Soporte orientable para ducha de mano. Flexo satinado.



- 20017001 **255,00**
- 20017001NM **395,00**
- 20017001BM **395,00**
- 20017001AC **395,00**
- 20017001OR **510,00**
- 20017001OM **510,00**

GRIFOS EMPOTRADOS

Grifo monomando empotrado de 1 vía para ducha
Cuerpo empotrado incluido.

20017701

110,00

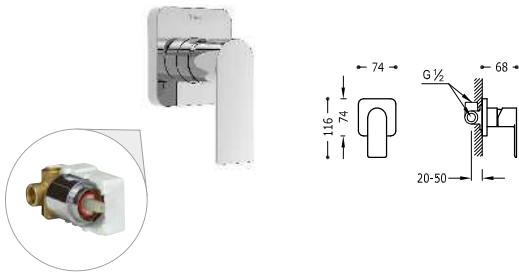

Grifo monomando empotrado de 2 vías para bañera y ducha
Cuerpo empotrado incluido. Inversor de 2 vías.

20018001

170,00

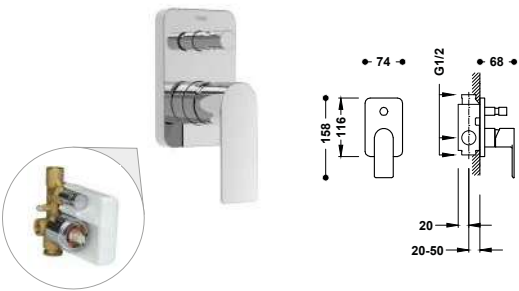

- 20018001NM 264,00
- 20018001BM 264,00
- 20018001AC 264,00
- 20018001OR 340,00
- 20018001OM 340,00

Set de prolongación para los grifos monomando empotrado de 2 vías

20018010

95,50



- 20018010OR 191,00 N
- 20018010OM 191,00 N

Kit de grifo monomando empotrado de 2 vías para ducha

20018011

456,00

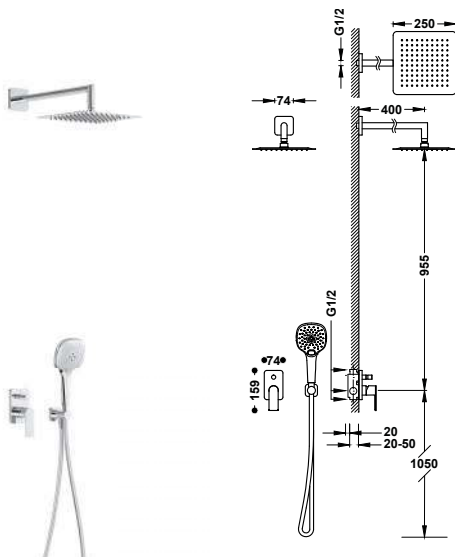

- Cuerpo empotrado incluido.
- Inversor de 2 vías.
- Brazo a pared con rociador de ducha orientable y de acero inoxidable: 250x250mm.
- Soporte para ducha de mano con toma de agua a pared.
- Ducha de mano anticalcárea: 120x120 mm. (3 tipos de chorro).
- Flexo satinado.

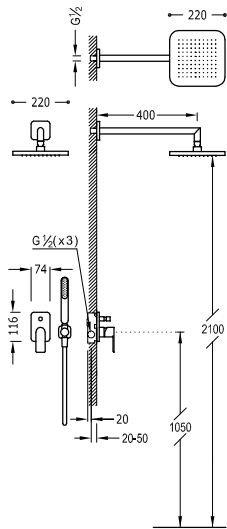

Kit de grifo monomando empotrado de 2 vías para ducha

20018002

482,00

- Cuerpo empotrado incluido.
- Inversor de 2 vías.
- Brazo a pared con rociador de ducha orientable: 220x220 mm.
- Soporte para ducha de mano con toma de agua a pared.
- Ducha de mano anticalcárea.
- Flexo satinado.



9130190

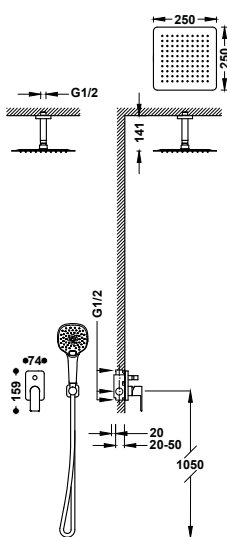

Kit de grifo monomando empotrado de 2 vías para ducha

20018009

422,00

- Cuerpo empotrado incluido.
- Inversor de 2 vías.
- Brazo a techo con rociador de ducha orientable y de acero inoxidable: 250x250mm.
- Soporte para ducha de mano con toma de agua a pared.
- Ducha de mano anticalcárea: 120x120 mm. (3 tipos de chorro).
- Flexo satinado.



9130190

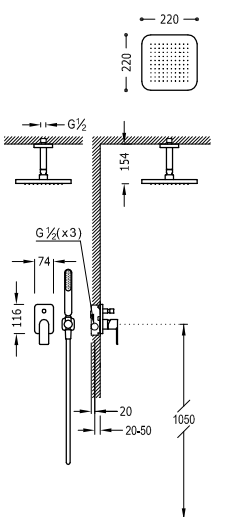

Kit de grifo monomando empotrado de 2 vías para ducha

20018080

449,00

- Cuerpo empotrado incluido.
- Inversor de 2 vías.
- Brazo a techo con rociador de ducha orientable: 220x220 mm.
- Soporte para ducha de mano con toma de agua a pared.
- Ducha de mano anticalcárea.
- Flexo satinado.





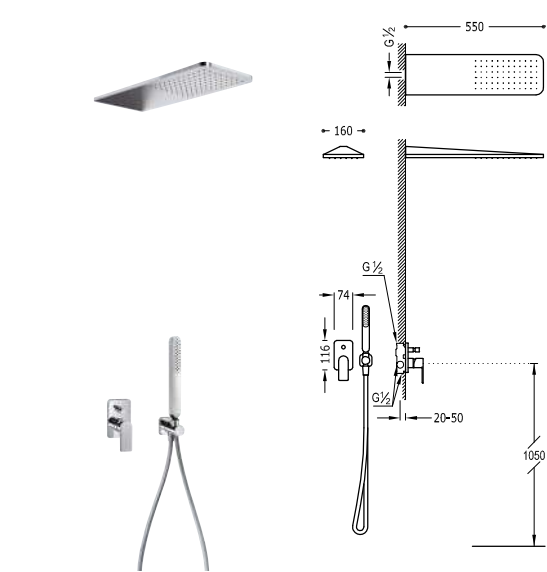



9130190



Kit de grifo monomando empotrado de 2 vías para ducha

- Cuerpo empotrado incluido.
- Inversor de 2 vías.
- Rociador de ducha a pared de acero inoxidable: 160x550 mm.
- Soporte para ducha de mano con toma de agua a pared.
- Ducha de mano anticalcárea.
- Flexo satinado.

	20018005	750,00
	20018005NM	1.163,00
	20018005BM	1.163,00
	20018005AC	1.163,00
	20018005OR	1.500,00
	20018005OM	1.500,00





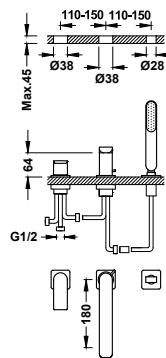



GRIFOS PARA BAÑERA



Grifo monomando para borde de bañera

- Inversor integrado en el caño de bañera.
- Ducha de mano anticalcárea.
- Caño de bañera de 180 mm. Caudal: 3 bar - 16 l/min.
- Kit depósito opcional no incluido ref.: 20324501.

	20016203	390,00
	20016203NM	605,00
	20016203BM	605,00
	20016203AC	605,00
	20016203OR	780,00
	20016203OM	780,00







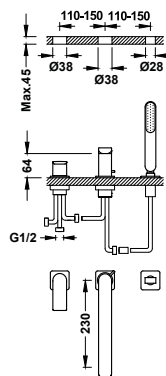

Depósito para grifería de borde de bañera

	20324501	395,00
---	----------	---------------



Grifo monomando para borde de bañera

- Inversor integrado en el caño de bañera.
- Ducha de mano anticalcárea.
- Caño de bañera de 230 mm. Caudal: 3 bar - 16 l/m.
- Kit depósito opcional no incluido ref.: 20324501.

	20016201	400,00
	20016201NM	620,00
	20016201BM	620,00
	20016201AC	620,00
	20016201OR	800,00
	20016201OM	800,00



Depósito para grifería de borde de bañera

	20324501	395,00
---	----------	---------------

GRIFOS TERMOSTÁTICOS MURALES

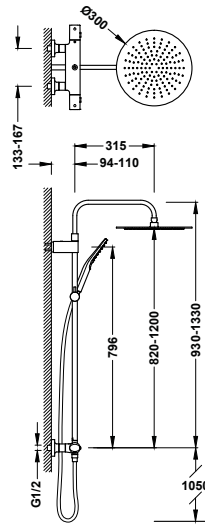

Conjunto de grifo termostático mural Over-wall de 2 vías para ducha

- Con inversor integrado en el regulador de caudal.
- Volante ovalado.
- Barra de ducha telescópica.
- Rociador de ducha orientable de acero inoxidable: Ø 300 mm.
- Soporte deslizante y orientable para ducha de mano.
- Ducha de mano anticalcárea: Ø 110 mm. (3 tipos de chorro).
- Flexo satinado.

19038705 **563,00**

19038705NM **873,00**

19038705BM **873,00**

19038705AC **873,00**

19038705OM **1.126,00**



GRIFOS TERMOSTÁTICOS EMPOTRADOS

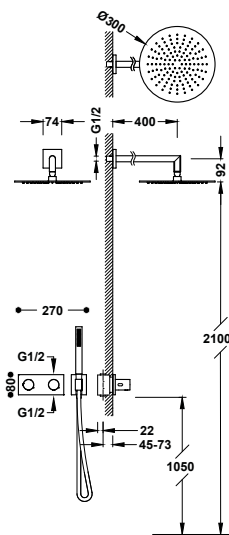

Kit de grifo termostático empotrado de 2 vías B-system para ducha

- Cuerpo empotrado termostático de instalación horizontal incluido.
- Regulador de caudal y distribuidor cerámico de 2 vías.
- Volante redondo.
- Brazo a pared con rociador de ducha orientable y de acero inoxidable: Ø 300 mm.
- Soporte para ducha de mano con toma de agua a pared.
- Ducha de mano anticalcárea de latón.
- Flexo satinado.

30735204 **803,00**

30735204NM **1.245,00**

30735204AC **1.245,00**

30735204OR **1.606,00**

30735204OM **1.606,00**

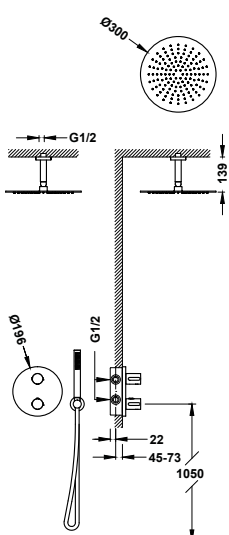

Kit de grifo termostático empotrado de 2 vías Therm-box para ducha

- Cuerpo empotrado incluido.
- Volante redondo con control de temperatura. Distribuidor cerámico de 2 vías.
- Brazo a techo con rociador de ducha orientable y de acero inoxidable: Ø 300 mm.
- Soporte para ducha de mano con toma de agua a pared.
- Ducha de mano anticalcárea de latón.
- Flexo satinado.

26225003 **546,00**

26225003NM **846,00**

26225003BM **846,00**

26225003AC **846,00**

26225003OR **1.092,00**





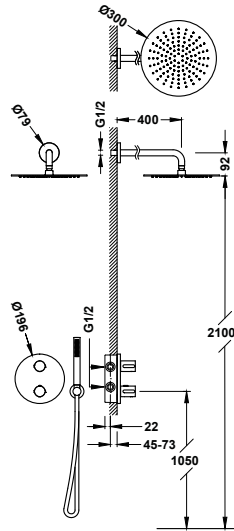

26225003OM **1.092,00**





Kit de grifo termostático empotrado de 2 vías Therm-box para ducha

- Cuerpo empotrado incluido.
- Volante redondo con control de temperatura. Distribuidor cerámico de 2 vías.
- Brazo a pared con rociador de ducha orientable y de acero inoxidable: Ø 300 mm.
- Soporte para ducha de mano con toma de agua a pared.
- Ducha de mano anticalcárea de latón.
- Flexo satinado.







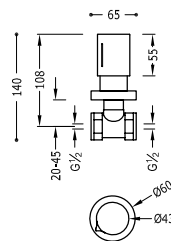

	26225004	571,00
	26225004NM	885,00
	26225004BM	885,00
	26225004AC	885,00
	26225004OR	1.142,00
	26225004OM	1.142,00



LLAVES DE PASO







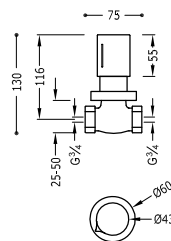



Llave de paso empotrada
Conexión a rosca hembra: 1/2".

	06115501	80,00
	06115501NM	124,00 
	06115501BM	124,00 
	06115501OR	160,00 
	06115501OM	160,00 



Llave de paso empotrada
Conexión a rosca hembra: 3/4".

	06151101	88,00
	06151101NM	136,00 
	06151101BM	136,00 
	06151101OR	176,00 
	06151101OM	176,00 



FUJI

Las formas cónicas de la colección Fuji de Tres se representan en cada una de las piezas. Su silueta sinuosa es lo que consigue este dinamismo tan atractivo para los baños modernos y eleva la notoriedad y presencia de cada grifo.

Acabados disponibles:



CR



NM



AC







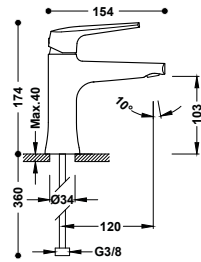

GRIFOS PARA LAVABO



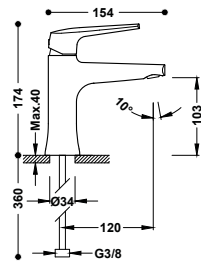

Grifo monomando para lavabo
Latiguillos de alimentación flexibles G3/8.

-  28110301 **115,00**
-  28110301NM **178,00**
-  28110301AC **178,00**



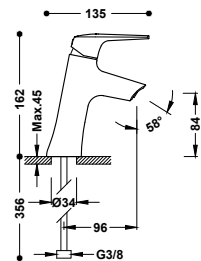

Grifo monomando ecoeficiente para lavabo
Latiguillos de alimentación flexibles G3/8.

-  28110401 **123,00**
-  28110401NM **191,00**
-  28110401AC **191,00**



Grifo monomando inclinado para lavabo
Latiguillos de alimentación flexibles G3/8.

-  28190301 **119,00**
-  28190301NM **184,00**
-  28190301AC **184,00**

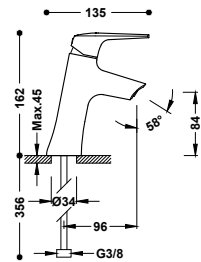

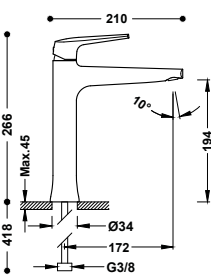

Grifo monomando inclinado ecoeficiente para lavabo
Latiguillos de alimentación flexibles G3/8.

-  28110402 **127,00**
-  28110402NM **197,00**
-  28110402AC **197,00**



Grifo monomando alto para lavabo
Latiguillos de alimentación flexibles G3/8.

-  28120301 **225,00**
-  28120301NM **349,00**
-  28120301AC **349,00**



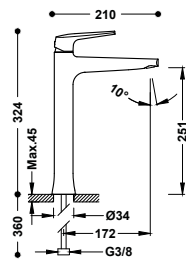



Grifo monomando XXL para lavabo
Latiguillos de alimentación flexibles G3/8.



29902802

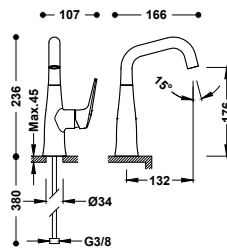

-  28180301 **260,00**
-  28180301NM **403,00**
-  28180301AC **403,00**



Grifo monomando con maneta lateral para lavabo
Latiguillos de alimentación flexibles G3/8.



29902804

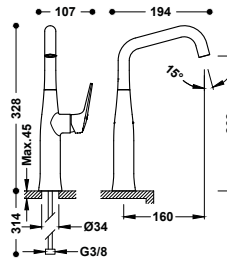

-  28144701 **200,00**
-  28144701NM **310,00**
-  28144701AC **310,00**



Grifo monomando alto con maneta lateral para lavabo
Latiguillos de alimentación flexibles G3/8.



29902804

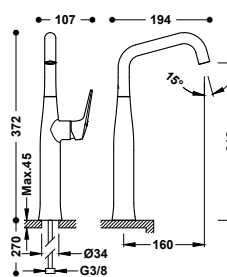

-  28164701 **210,00**
-  28164701NM **326,00**
-  28164701AC **326,00**



Grifo monomando XXL con maneta lateral para lavabo
Latiguillos de alimentación flexibles G3/8.



29902804

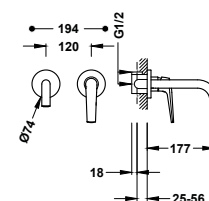

-  28184701 **225,00**
-  28184701NM **349,00**
-  28184701AC **349,00**



Grifo monomando empotrado para lavabo
Cuerpo empotrado indivisible con amortiguadores acústicos. Junta antihumedad. Caño de 177 mm.



29902801

-  28130001 **230,00**
-  28130001NM **357,00**
-  28130001AC **357,00**

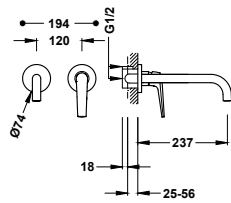

Grifo monomando empotrado para lavabo

Cuerpo empotrado indivisible con amortiguadores acústicos. Junta antihumedad. Caño de 237 mm.

- 28130002 **240,00**
- 28130002NM **372,00**
- 28130002AC **372,00**

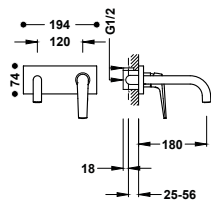

Grifo monomando empotrado para lavabo

Cuerpo empotrado indivisible con amortiguadores acústicos. Junta antihumedad. Caño de 180 mm.

- 28130003 **270,00**
- 28130003NM **419,00**
- 28130003AC **419,00**

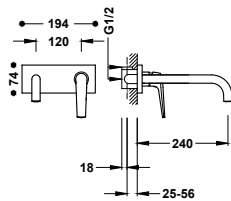

Grifo monomando empotrado para lavabo

Cuerpo empotrado indivisible con amortiguadores acústicos. Junta antihumedad. Caño de 240 mm.

- 28130004 **280,00**
- 28130004NM **434,00**
- 28130004AC **434,00**



GRIFOS PARA BIDÉ

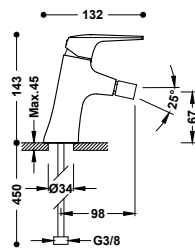

Grifo monomando para bidé

Rótula orientable. Latiguillos de alimentación flexibles G3/8.

- 28112001 **122,00**
- 28112001NM **189,00**
- 28112001AC **189,00**

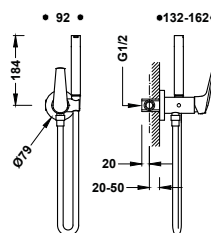

Grifo monomando empotrado con ducha para inodoro

Con agua fría o caliente. Ducha de mano con racor limitador a 5 l/min. y sistema antigoteo. Soporte fijo para la ducha de mano instalable a derecha o izquierda. Flexo satinado.

- 28112301 **180,00**
- 28112301NM **279,00**
- 28112301AC **279,00**



GRIFOS MURALES

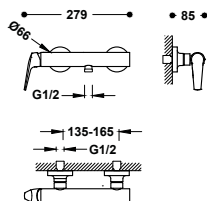

Grifo monomando mural para ducha

Ducha de mano anticalcárea: Ø 110 mm. (3 tipos de chorro). Soporte orientable para ducha de mano. Flexo satinado.

- 28116701 **230,00**
- 28116701NM **357,00**
- 28116701AC **357,00**



29902802

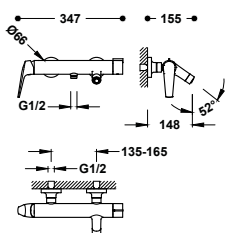

Grifo monomando mural para bañera y ducha

Ducha de mano anticalcárea: Ø 110 mm. (3 tipos de chorro). Soporte orientable para ducha de mano. Flexo satinado.

- 28117001 **250,00**
- 28117001NM **388,00**
- 28117001AC **388,00**



29903516

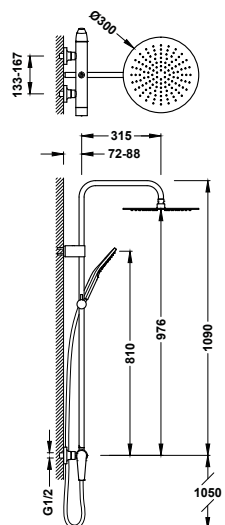

Conjunto de grifo monomando mural de 2 vías para ducha

- Rociador de ducha orientable de acero inoxidable: Ø 300 mm.
- Soporte deslizante y orientable para ducha de mano.
- Ducha de mano anticalcárea: Ø 110 mm. (3 tipos de chorro).
- Flexo satinado.

- 28119101 **473,00**
- 28119101NM **733,00**
- 28119101AC **733,00**



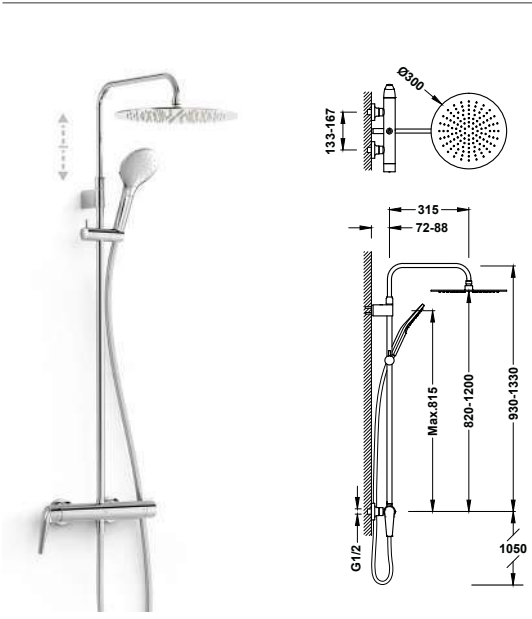

INOX 29903516



Conjunto de grifo monomando mural de 2 vías para ducha

- Rociador de ducha orientable de acero inoxidable: Ø 300 mm.
- Barra de ducha telescópica.
- Soporte deslizante y orientable para ducha de mano.
- Ducha de mano anticalcárea: Ø 110 mm. (3 tipos de chorro).
- Flexo satinado.



	28119701	503,00
	28119701NM	780,00
	28119701AC	780,00



GRIFOS EMPOTRADOS RAPID-BOX

Pieza vista para caja empotrada de 1 vía Rapid-box

Sólo parte vista. Incluye placa embellecedora, mando, casquillo y tornillo de fijación oculto. Caja empotrada no incluida.

	28127810	75,00
	28127810NM	116,00
	28127810AC	116,00

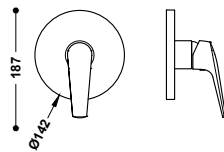



Caja empotrada de 1 vía Rapid-box con grifo monomando para ducha

20827810	80,00 N
----------	----------------



Pieza vista para caja empotrada de 2 vías Rapid-box

Sólo parte vista. Incluye placa embellecedora, mando, volante distribuidor y tornillo de fijación oculto. Caja empotrada no incluida.

	28128110	95,00
	28128110NM	147,00
	28128110AC	147,00

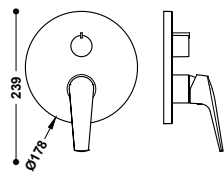

Caja empotrada de 2 vías Rapid-box con grifo monomando para ducha y bañera



20828110	90,00 N
----------	----------------

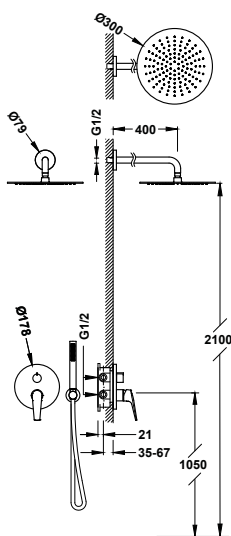



Kit de grifo monomando empotrado de 2 vías Rapid-box para ducha

- Cuerpo empotrado incluido.
- Distribuidor cerámico de 2 vías.
- Brazo a pared con rociador de ducha orientable y de acero inoxidable: Ø 300 mm.
- Soporte para ducha de mano con toma de agua a pared.
- Ducha de mano anticalcárea de latón.
- Flexo satinado.

	28128004	446,00
	28128004NM	691,00
	28128004AC	691,00





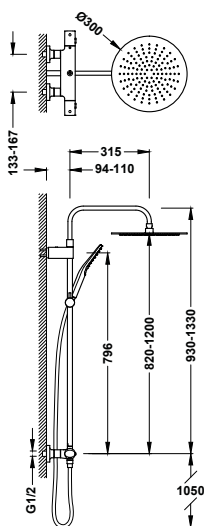

GRIFOS TERMOSTÁTICOS MURALES



Conjunto de grifo termostático mural Over-wall de 2 vías para ducha



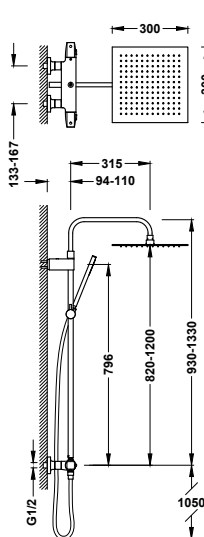

- Con inversor integrado en el regulador de caudal.
- Volante ovalado.
- Barra de ducha telescópica.
- Rociador de ducha orientable de acero inoxidable: Ø 300 mm.
- Soporte deslizante y orientable para ducha de mano.
- Ducha de mano anticalcárea: Ø 110 mm. (3 tipos de chorro).
- Flexo satinado.

	19038705	563,00
	19038705NM	873,00
	19038705BM	873,00
	19038705AC	873,00



Conjunto de grifo termostático mural Over-wall de 2 vías para ducha

- Con inversor integrado en el regulador de caudal.
- Volante cuadrado-redondo.
- Barra de ducha telescópica.
- Rociador de ducha orientable de acero inoxidable: 300x300 mm.
- Soporte deslizante y orientable para ducha de mano.
- Ducha de mano anticalcárea de latón.
- Flexo satinado.

	19039307	598,00
	19039307NM	927,00
	19039307BM	927,00
	19039307AC	927,00



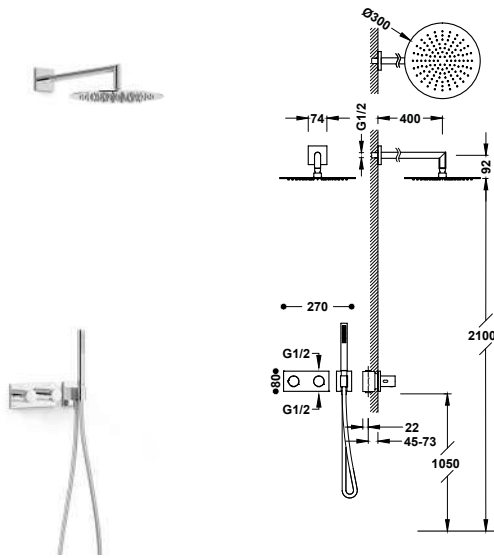

GRIFOS TERMOSTÁTICOS EMPOTRADOS



Kit de grifo termostático empotrado de 2 vías B-system para ducha

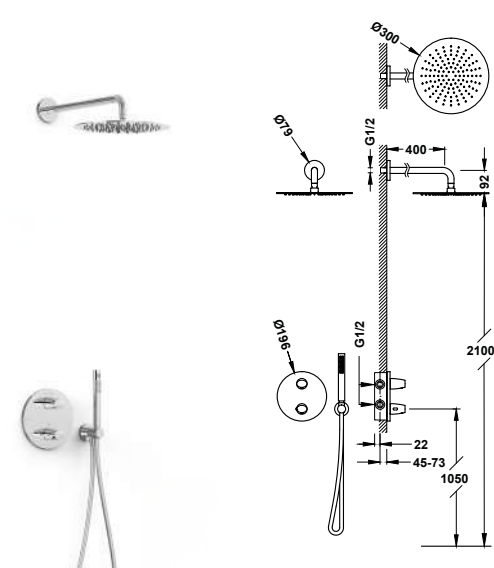

- Cuerpo empotrado termostático de instalación horizontal incluido.
- Regulador de caudal y distribuidor cerámico de 2 vías.
- Volante redondo.
- Brazo a pared con rociador de ducha orientable y de acero inoxidable: Ø 300 mm.
- Soporte para ducha de mano con toma de agua a pared.
- Ducha de mano anticalcárea de latón.
- Flexo satinado.

	30735204	803,00
	30735204NM	1.245,00
	30735204AC	1.245,00



Kit de grifo termostático empotrado de 2 vías Therm-box para ducha

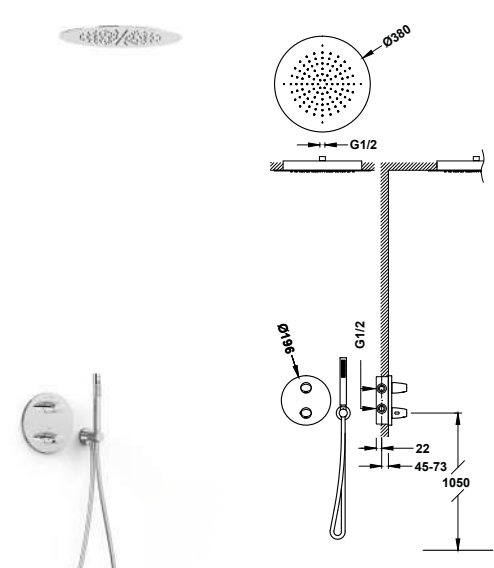

- Cuerpo empotrado incluido.
- Volante ovalado con control de temperatura. Distribuidor cerámico de 2 vías.
- Brazo a pared con rociador de ducha orientable y de acero inoxidable: Ø 300 mm.
- Soporte para ducha de mano con toma de agua a pared.
- Ducha de mano anticalcárea de latón.
- Flexo satinado.

	28125004	551,00
	28125004NM	854,00
	28125004AC	854,00



Kit de grifo termostático empotrado de 2 vías Therm-box para ducha

- Cuerpo empotrado incluido.
- Volante ovalado con control de temperatura. Distribuidor cerámico de 2 vías.
- Rociador de ducha empotrado a techo de acero inoxidable: Ø 380 mm.
- Soporte para ducha de mano con toma de agua a pared.
- Ducha de mano anticalcárea de latón.
- Flexo satinado.

	28125005	1.102,00
	28125005NM	1.708,00
	28125005AC	1.708,00



PROJECT-TRES

Project-tres es la serie más especial de Tres. Adaptable a muchos entornos y con acabados sorprendentes, esta serie mezcla la innovación tecnológica con el diseño más versátil. Por algo será que a todo el mundo le gusta.

Acabados disponibles:

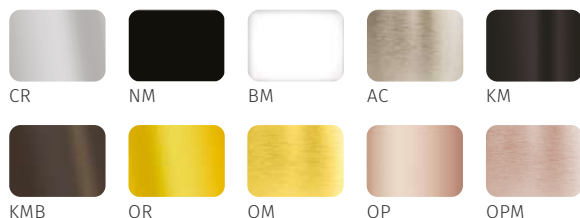



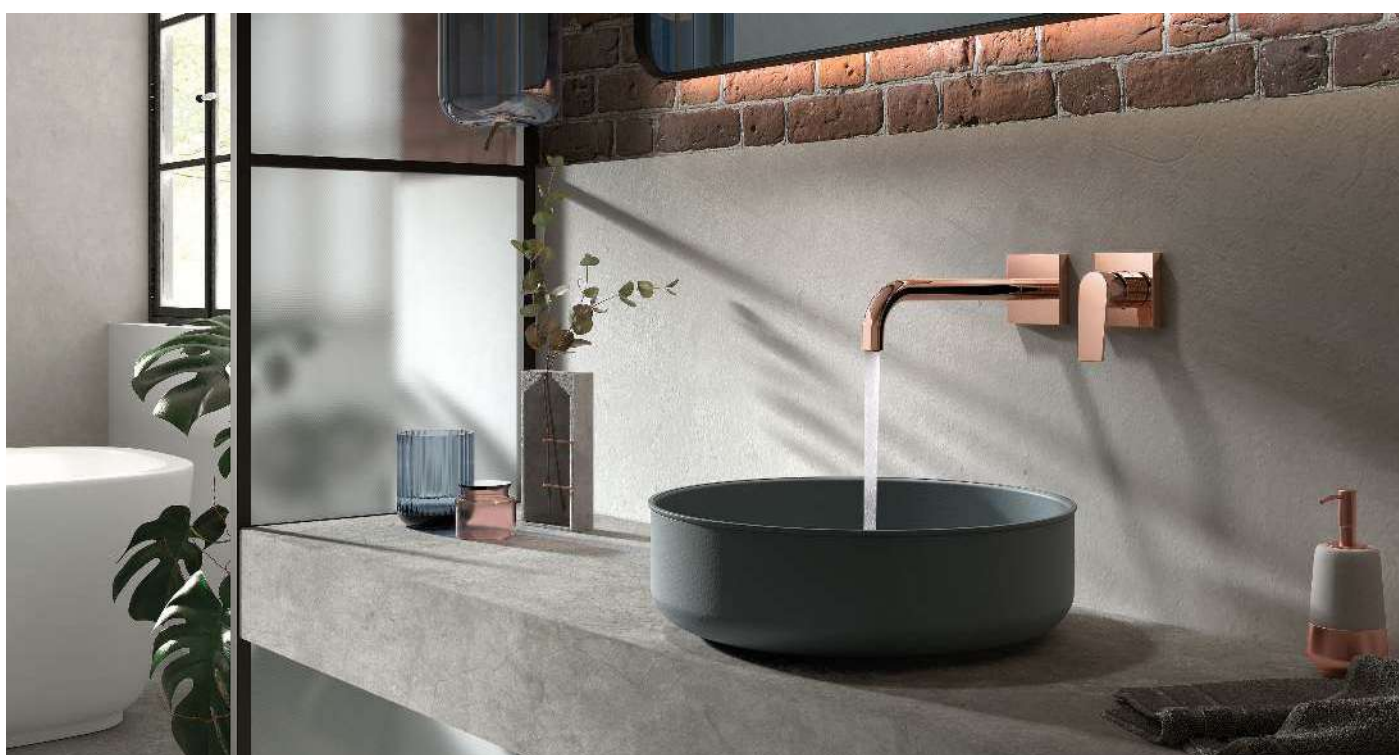

GRIFOS PARA LAVABO

Grifo monomando para lavabo

Latiguillos de alimentación flexibles G3/8.

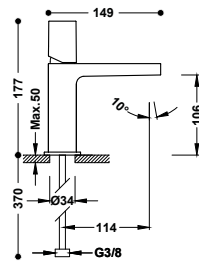

9130190

- 21110302 106,00
- 21110302D 128,00

- 21110302NM 164,00
- 21110302BM 164,00
- 21110302AC 164,00
- 21110302KM 164,00
- 21110302KMB 164,00
- 21110302OR 212,00
- 21110302OM 212,00
- 21110302OP 212,00
- 21110302OPM 212,00 N

Grifo monomando alto para lavabo

Latiguillos de alimentación flexibles G3/8.

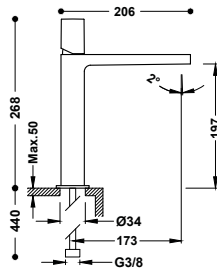

9130190

- 21120302 222,00

- 21120302NM 344,00
- 21120302BM 344,00
- 21120302AC 344,00
- 21120302KM 344,00
- 21120302KMB 344,00
- 21120302OR 444,00
- 21120302OM 444,00
- 21120302OP 444,00
- 21120302OPM 444,00 N

Grifo monomando XXL para lavabo

Latiguillos de alimentación flexibles G3/8.

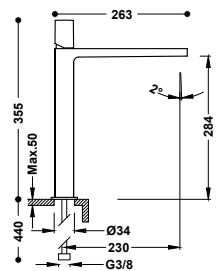

9130190

- 21180302 255,00

- 21180302NM 395,00
- 21180302BM 395,00
- 21180302AC 395,00
- 21180302KM 395,00
- 21180302KMB 395,00
- 21180302OR 510,00
- 21180302OM 510,00
- 21180302OP 510,00
- 21180302OPM 510,00 N

Grifo monomando para lavabo

Latiguillos de alimentación flexibles G3/8.

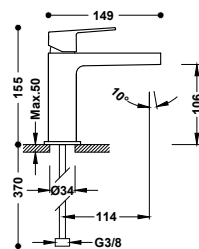

9130190

- 21110301 106,00
- 21110301D 128,00

- 21110301NM 164,00
- 21110301BM 164,00
- 21110301AC 164,00
- 21110301KM 164,00
- 21110301KMB 164,00
- 21110301OR 212,00
- 21110301OM 212,00
- 21110301OP 212,00
- 21110301OPM 212,00

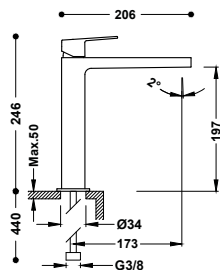

Grifo monomando alto para lavabo
Latiguillos de alimentación flexibles G3/8.



- 21120301 **222,00**
- 21120301NM **344,00**
- 21120301BM **344,00**
- 21120301AC **344,00**
- 21120301KM **344,00**
- 21120301KMB **344,00**
- 21120301OR **444,00**
- 21120301OM **444,00**
- 21120301OP **444,00**
- 21120301OPM **444,00**

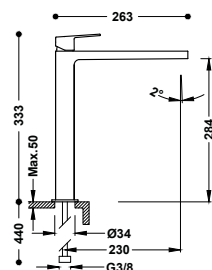

Grifo monomando XXL para lavabo
Latiguillos de alimentación flexibles G3/8.



- 21180301 **255,00**
- 21180301NM **395,00**
- 21180301BM **395,00**
- 21180301AC **395,00**
- 21180301KM **395,00**
- 21180301KMB **395,00**
- 21180301OR **510,00**
- 21180301OM **510,00**
- 21180301OP **510,00**
- 21180301OPM **510,00**

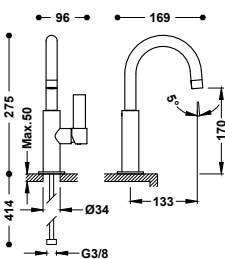

Grifo monomando con maneta lateral para lavabo
Latiguillos de alimentación flexibles G3/8.



- 21190401 **198,00**
- 21190401NM **307,00**
- 21190401BM **307,00**
- 21190401AC **307,00**
- 21190401KM **307,00**
- 21190401KMB **307,00**
- 21190401OR **396,00**
- 21190401OM **396,00**
- 21190401OP **396,00**
- 21190401OPM **396,00** N

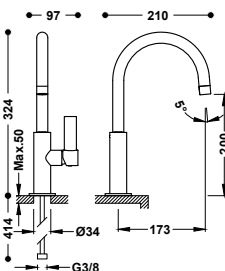

Grifo monomando alto con maneta lateral para lavabo
Latiguillos de alimentación flexibles G3/8.



- 21190501 **208,00**
- 21190501NM **322,00**
- 21190501BM **322,00**
- 21190501AC **322,00**
- 21190501KM **322,00**
- 21190501KMB **322,00**
- 21190501OR **416,00**
- 21190501OM **416,00**
- 21190501OP **416,00**
- 21190501OPM **416,00** N

Grifo monomando XXL con maneta lateral para lavabo
 Latiguillos de alimentación flexibles G3/8.

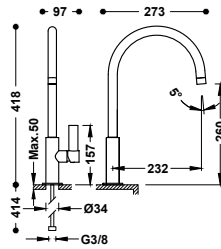

- 21190601 **218,00**
- 21190601NM **338,00**
- 21190601BM **338,00**
- 21190601AC **338,00**
- 21190601KM **338,00**
- 21190601KMB **338,00**
- 21190601OR **436,00**
- 21190601OM **436,00**
- 21190601OP **436,00**
- 21190601OPM **436,00** N

Grifo monomando con maneta lateral para lavabo
 Latiguillos de alimentación flexibles G3/8.

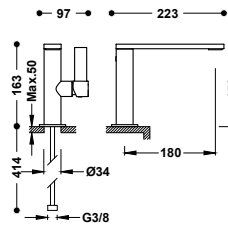

- 21120501 **175,00**
- 21120501NM **271,00**
- 21120501BM **271,00**
- 21120501AC **271,00**
- 21120501KM **271,00**
- 21120501KMB **271,00**
- 21120501OR **350,00**
- 21120501OM **350,00**
- 21120501OP **350,00**
- 21120501OPM **350,00** N

Grifo monomando alto con maneta lateral para lavabo
 Latiguillos de alimentación flexibles G3/8.

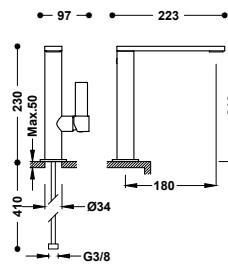

- 21130501 **195,00**
- 21130501NM **302,00**
- 21130501BM **302,00**
- 21130501AC **302,00**
- 21130501KM **302,00**
- 21130501KMB **302,00**
- 21130501OR **390,00**
- 21130501OM **390,00**
- 21130501OP **390,00**
- 21130501OPM **390,00** N

Grifo monomando XXL con maneta lateral para lavabo
 Latiguillos de alimentación flexibles G3/8.

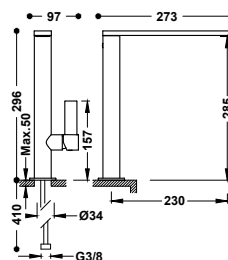

- 21140501 **215,00**
- 21140501NM **333,00**
- 21140501BM **333,00**
- 21140501AC **333,00**
- 21140501KM **333,00**
- 21140501KMB **333,00**
- 21140501OR **430,00**
- 21140501OM **430,00**
- 21140501OP **430,00**
- 21140501OPM **430,00** N

Grifo de 1 agua para lavabo
 Con latiguillo de alimentación flexible G3/8.

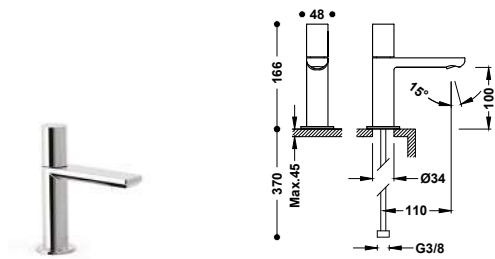

- 21150301 **100,00**
- 21150301NM **155,00**
- 21150301BM **155,00**
- 21150301AC **155,00**
- 21150301KM **155,00**
- 21150301KMB **155,00**
- 21150301OR **200,00**
- 21150301OM **200,00**
- 21150301OP **200,00**
- 21150301OPM **200,00** N

Grifo monomando empotrado para lavabo
 Cuerpo empotrado indivisible con amortiguadores acústicos. Junta antihumedad. Caño de 180 mm.

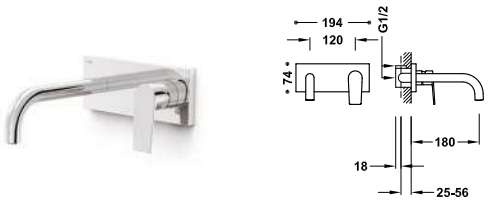

- 21130011 **260,00**
- 21130011NM **403,00**
- 21130011BM **403,00**
- 21130011AC **403,00**
- 21130011KM **403,00**
- 21130011KMB **403,00**
- 21130011OR **520,00**
- 21130011OM **520,00**
- 21130011OP **520,00**
- 21130011OPM **520,00** N

Grifo monomando empotrado para lavabo
 Cuerpo empotrado indivisible con amortiguadores acústicos. Junta antihumedad. Caño de 240 mm.

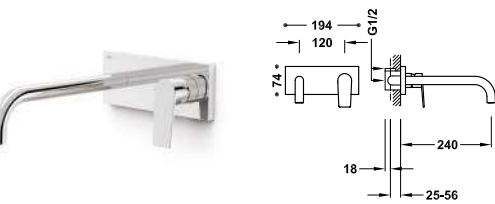

- 21130012 **270,00**
- 21130012NM **419,00**
- 21130012BM **419,00**
- 21130012AC **419,00**
- 21130012KM **419,00**
- 21130012KMB **419,00**
- 21130012OR **540,00**
- 21130012OM **540,00**
- 21130012OP **540,00**
- 21130012OPM **540,00** N

Grifo monomando empotrado para lavabo
 Cuerpo empotrado indivisible con amortiguadores acústicos. Junta antihumedad. Caño de 180 mm.

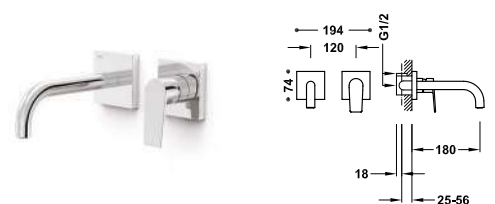

- 21130001 **225,00**
- 21130001NM **349,00**
- 21130001BM **349,00**
- 21130001AC **349,00**
- 21130001KM **349,00**
- 21130001KMB **349,00**
- 21130001OR **450,00**
- 21130001OM **450,00**
- 21130001OP **450,00**
- 21130001OPM **450,00**

Grifo monomando empotrado para lavabo

Cuerpo empotrado indivisible con amortiguadores acústicos. Junta antihumedad. Caño de 240 mm.

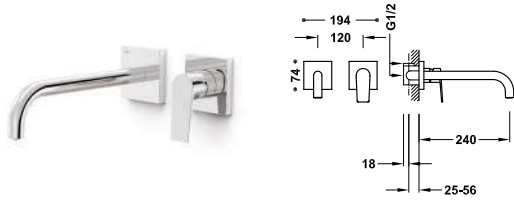

- 21130002 **235,00**
- 21130002NM **364,00**
- 21130002BM **364,00**
- 21130002AC **364,00**
- 21130002KM **364,00**
- 21130002KMB **364,00**
- 21130002OR **470,00**
- 21130002OM **470,00**
- 21130002OP **470,00**
- 21130002OPM **470,00** N

GRIFOS PARA BIDÉ

Grifo monomando para bidé

Rótula orientable. Latiguillos de alimentación flexibles G3/8.

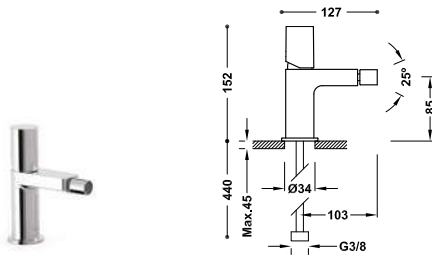

- 21112002 **109,00**
- 21112002D **131,00**
- 21112002NM **169,00**
- 21112002BM **169,00**
- 21112002AC **169,00**
- 21112002KM **169,00**
- 21112002KMB **169,00**
- 21112002OR **218,00**
- 21112002OM **218,00**
- 21112002OP **218,00**
- 21112002OPM **218,00** N

Grifo monomando para bidé

Rótula orientable. Latiguillos de alimentación flexibles G3/8.

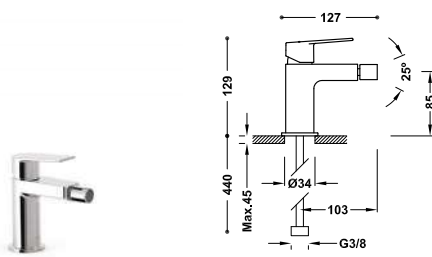

- 21112001 **109,00**
- 21112001D **131,00**
- 21112001NM **169,00**
- 21112001BM **169,00**
- 21112001AC **169,00**
- 21112001KM **169,00**
- 21112001KMB **169,00**
- 21112001OR **218,00**
- 21112001OM **218,00**
- 21112001OP **218,00**
- 21112001OPM **218,00**

Grifo monomando con maneta lateral para bidé

Rótula orientable. Latiguillos de alimentación flexibles G3/8.

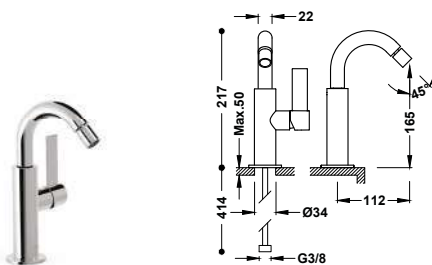

- 21122401 **190,00**
- 21122401NM **295,00**
- 21122401BM **295,00**
- 21122401AC **295,00**
- 21122401KM **295,00**
- 21122401KMB **295,00**
- 21122401OR **380,00**
- 21122401OM **380,00**
- 21122401OP **380,00**
- 21122401OPM **380,00** N

GRIFOS MURALES

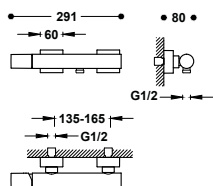

Grifo monomando mural para ducha

Ducha de mano anticalcárea de latón. Soporte orientable para ducha de mano. Flexo satinado.

- 21116701 **220,00**
- 21116701NM **341,00**
- 21116701BM **341,00**
- 21116701AC **341,00**
- 21116701KM **341,00**
- 21116701KMB **341,00**
- 21116701OR **440,00**
- 21116701OM **440,00**
- 21116701OP **440,00**
- 21116701OPM **440,00**

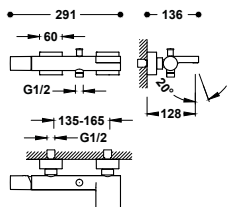

Grifo monomando mural para bañera y ducha

Con salida de agua en cascada. Ducha de mano anticalcárea de latón. Soporte orientable para ducha de mano. Flexo satinado.

- 21117001 **240,00**
- 21117001NM **372,00**
- 21117001BM **372,00**
- 21117001AC **372,00**
- 21117001KM **372,00**
- 21117001KMB **372,00**
- 21117001OR **480,00**
- 21117001OM **480,00**
- 21117001OP **480,00**
- 21117001OPM **480,00**



GRIFOS EMPOTRADOS RAPID-BOX

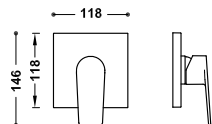

Pieza vista para caja empotrada de 1 vía Rapid-box

Sólo parte vista. Incluye placa embellecedora, mando, casquillo y tornillo de fijación oculto. Caja empotrada no incluida.

- 21127810 **75,00**
- 21127810NM **116,00**
- 21127810BM **116,00**
- 21127810AC **116,00**
- 21127810KM **116,00**
- 21127810KMB **116,00**
- 21127810OR **150,00**
- 21127810OM **150,00**
- 21127810OP **150,00**
- 21127810OPM **150,00**



Caja empotrada de 1 vía Rapid-box con grifo monomando para ducha

20827810 **80,00**

Pieza vista para caja empotrada de 2 vías Rapid-box

Sólo parte vista. Incluye placa embellecedora, mando, volante distribuidor y tornillo de fijación oculto. **Caja empotrada no incluida.**

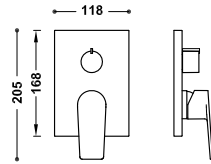

	21128110	95,00
	21128110NM	147,00
	21128110BM	147,00
	21128110AC	147,00
	21128110KM	147,00
	21128110KMB	147,00
	21128110OR	190,00
	21128110OM	190,00
	21128110OP	190,00
	21128110OPM	190,00

Caja empotrada de 2 vías Rapid-box con grifo monomando para ducha y bañera

20828110 90,00 **N**



Kit de grifo monomando empotrado de 2 vías Rapid-box para ducha

- Cuerpo empotrado incluido.
- Distribuidor cerámico de 2 vías.
- Brazo a pared con rociador de ducha orientable y de acero inoxidable: 300x300 mm.
- Soporte para ducha de mano con toma de agua a pared.
- Ducha de mano anticalcárea de latón.
- Flexo satinado.

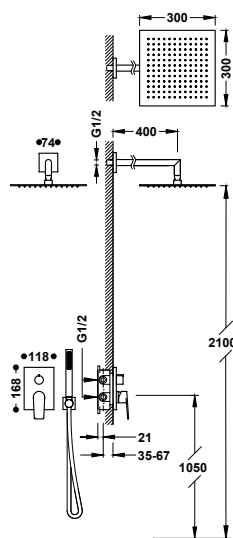

	21128004	537,00
	21128004NM	832,00
	21128004BM	832,00
	21128004AC	832,00
	21128004KM	832,00
	21128004KMB	832,00
	21128004OR	1.074,00
	21128004OM	1.074,00
	21128004OP	1.074,00
	21128004OPM	1.074,00



29903508

Kit de grifo monomando empotrado de 2 vías Rapid-box para ducha

- Cuerpo empotrado incluido.
- Distribuidor cerámico de 2 vías.
- Brazo a techo con rociador de ducha orientable y de acero inoxidable: 300x300 mm.
- Soporte para ducha de mano con toma de agua a pared.
- Ducha de mano anticalcárea de latón.
- Flexo satinado.

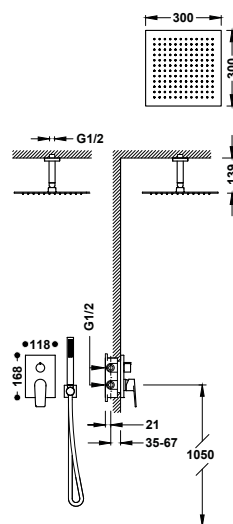

	21128003	504,00
	21128003NM	781,00
	21128003BM	781,00
	21128003AC	781,00
	21128003KM	781,00
	21128003KMB	781,00
	21128003OR	1.008,00
	21128003OM	1.008,00
	21128003OP	1.008,00
	21128003OPM	1.008,00 N



29903508

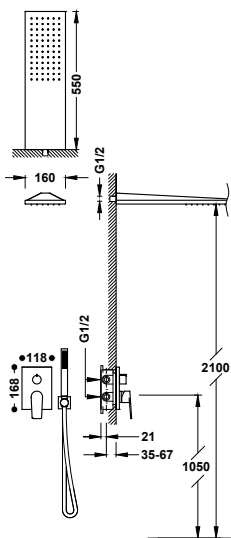

Kit de grifo monomando empotrado de 2 vías Rapid-box para ducha

- Cuerpo empotrado incluido.
- Distribuidor cerámico de 2 vías.
- Rociador de ducha a pared de acero inoxidable: 160x550 mm.
- Soporte para ducha de mano con toma de agua a pared.
- Ducha de mano anticalcárea de latón.
- Flexo satinado.

	21128005	718,00
	21128005NM	1.113,00
	21128005BM	1.113,00
	21128005AC	1.113,00
	21128005KM	1.113,00
	21128005KMB	1.113,00
	21128005OR	1.436,00
	21128005OM	1.436,00
	21128005OP	1.436,00
	21128005OPM	1.436,00 N



29903508

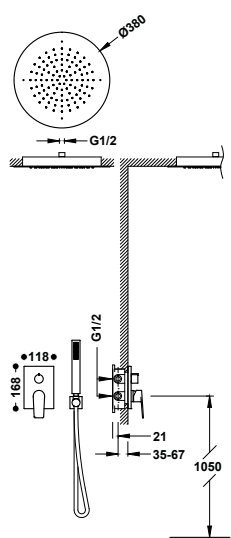

Kit de grifo monomando empotrado de 2 vías Rapid-box para ducha

- Cuerpo empotrado incluido.
- Distribuidor cerámico de 2 vías.
- Rociador de ducha empotrado a techo de acero inoxidable: Ø 380 mm.
- Soporte para ducha de mano con toma de agua a pared.
- Ducha de mano anticalcárea de latón.
- Flexo satinado.

	21128006	1.055,00
	21128006NM	1.635,00
	21128006BM	1.635,00
	21128006AC	1.635,00
	21128006KM	1.635,00
	21128006KMB	1.635,00
	21128006OR	2.110,00
	21128006OM	2.110,00
	21128006OP	2.110,00
	21128006OPM	2.110,00 N



29903508

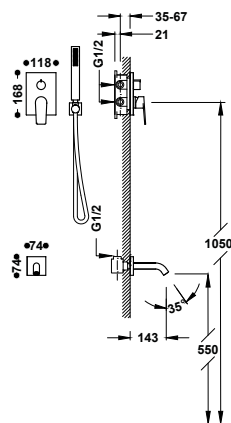

Kit de grifo monomando empotrado de 2 vías Rapid-box para bañera y ducha

- Cuerpo empotrado incluido.
- Distribuidor cerámico de 2 vías.
- Caño fijo de bañera a pared.
- Soporte para ducha de mano con toma de agua a pared.
- Ducha de mano anticalcárea de latón.
- Flexo satinado.

	21128007	394,00
	21128007NM	611,00
	21128007BM	611,00
	21128007AC	611,00
	21128007KM	611,00
	21128007KMB	611,00
	21128007OR	788,00
	21128007OM	788,00
	21128007OP	788,00
	21128007OPM	788,00 N



29903508

GRIFOS PARA BAÑERA

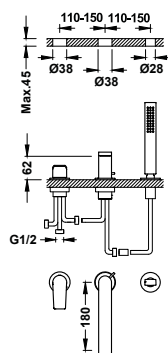

Grifo monomando para borde de bañera

- Inversor integrado en el caño de bañera.
- Ducha de mano anticalcárea de latón.
- Caño de bañera de 180 mm. Caudal: 3 bar - 13 l/min.
- Kit depósito opcional no incluido ref.: 20024501.



	21116101	370,00
	21116101NM	574,00
	21116101BM	574,00
	21116101AC	574,00
	21116101KM	574,00
	21116101KMB	574,00
	21116101OR	740,00
	21116101OM	740,00
	21116101OP	740,00
	21116101OPM	740,00 ^N



Depósito para grifería de borde de bañera

	20024501	395,00
--	----------	--------

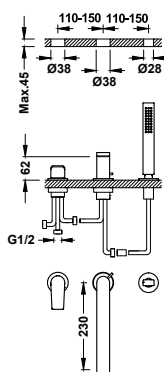

Grifo monomando para borde de bañera

- Inversor integrado en el caño de bañera.
- Ducha de mano anticalcárea de latón.
- Caño de bañera de 230 mm. Caudal: 3 bar - 13 l/min.
- Kit depósito opcional no incluido ref.: 20024501.



	21116103	380,00
	21116103NM	589,00
	21116103BM	589,00
	21116103AC	589,00
	21116103KM	589,00
	21116103KMB	589,00
	21116103OR	760,00
	21116103OM	760,00
	21116103OP	760,00
	21116103OPM	760,00 ^N



Depósito para grifería de borde de bañera

	20024501	395,00
--	----------	--------

GRIFOS TERMOSTÁTICOS MURALES

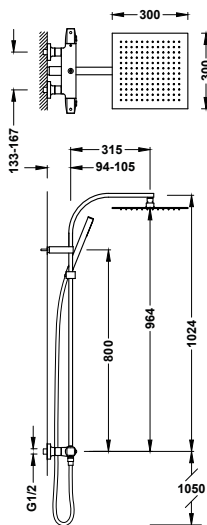

Conjunto de grifo termostático mural Over-wall de 2 vías para ducha

- Con inversor integrado en el regulador de caudal.
- Volante cuadrado-redondo.
- Rociador de ducha orientable de acero inoxidable: 300x300 mm.
- Soporte deslizante y orientable para ducha de mano.
- Ducha de mano anticalcárea de latón.
- Flexo satinado.

19039305	595,00
19039305NM	922,00
19039305BM	922,00
19039305AC	922,00
19039305KMB	922,00
19039305OM	1.190,00
19039305OPM	1.190,00

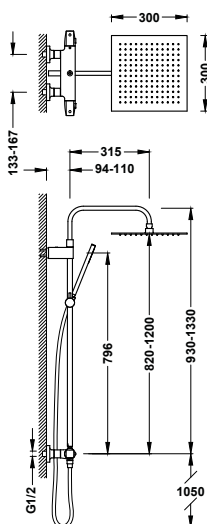

Conjunto de grifo termostático mural Over-wall de 2 vías para ducha

- Con inversor integrado en el regulador de caudal.
- Volante cuadrado-redondo.
- Barra de ducha telescópica.
- Rociador de ducha orientable de acero inoxidable: 300x300 mm.
- Soporte deslizante y orientable para ducha de mano.
- Ducha de mano anticalcárea de latón.
- Flexo satinado.

19039307	598,00
19039307NM	927,00
19039307BM	927,00
19039307AC	927,00
19039307KMB	927,00
19039307OM	1.196,00
19039307OPM	1.196,00



GRIFOS TERMOSTÁTICOS EMPOTRADOS

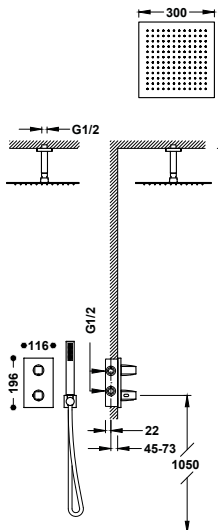

Kit de grifo termostático empotrado de 2 vías Therm-box para ducha

- Cuerpo empotrado incluido.
- Volante cuadrado-redondo con control de temperatura. Distribuidor cerámico de 2 vías.
- Brazo a techo con rociador de ducha orientable y de acero inoxidable: 300x300 mm.
- Soporte para ducha de mano con toma de agua a pared.
- Ducha de mano anticalcárea de latón.
- Flexo satinado.

21125003	559,00
21125003NM	866,00
21125003BM	866,00
21125003AC	866,00
21125003KM	866,00
21125003KMB	866,00
21125003OR	1.118,00
21125003OM	1.118,00
21125003OP	1.118,00
21125003OPM	1.118,00

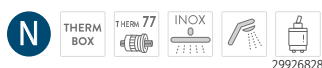

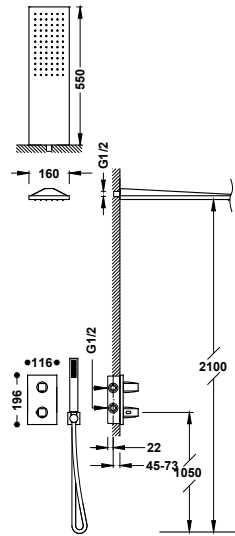

Kit de grifo termostático empotrado de 2 vías Therm-box para ducha

- Cuerpo empotrado incluido.
- Volante cuadrado-redondo con control de temperatura. Distribuidor cerámico de 2 vías.
- Rociador de ducha a pared de acero inoxidable: 160x550 mm.
- Soporte para ducha de mano con toma de agua a pared.
- Ducha de mano anticalcárea de latón.
- Flexo satinado.

	21125005	773,00
	21125005NM	1.198,00
	21125005BM	1.198,00
	21125005AC	1.198,00
	21125005KM	1.198,00
	21125005KMB	1.198,00
	21125005OR	1.546,00
	21125005OM	1.546,00
	21125005OP	1.546,00
	21125005OPM	1.546,00

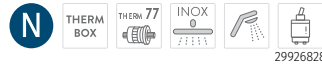

MAX

El cuidado estético junto con toda la tecnología desarrollada para su creación sitúan Max entre las series más elegantes y funcionales que aportan modernidad, sencillez y calidad al baño.

Acabados disponibles:



CR







GRIFOS PARA LAVABO

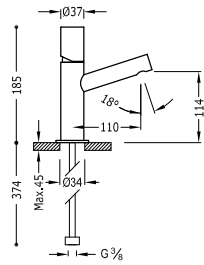

Grifo monomando para lavabo
Latiguillos de alimentación flexibles G3/8.

06110301 **104,00**
06110301D **126,00**

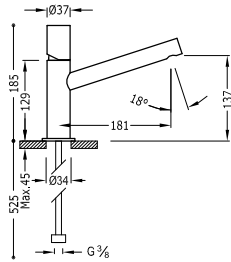

Grifo monomando para lavabo
Caño largo. Latiguillos de alimentación flexibles G3/8.

06120301 **119,00**
06120301D **141,00**

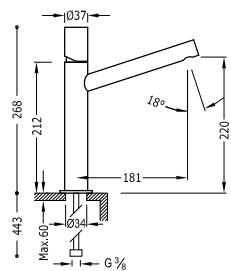

Grifo monomando alto para lavabo
Caño largo. Latiguillos de alimentación flexibles G3/8.

06120601 **207,00**

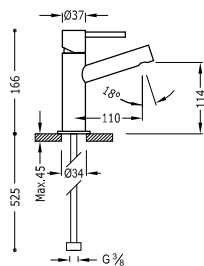

Grifo monomando para lavabo
Latiguillos de alimentación flexibles G3/8.

06210301 **104,00**
06210301D **126,00**

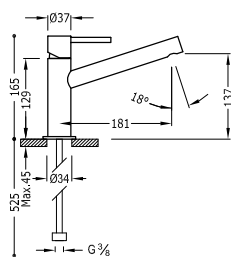

Grifo monomando para lavabo
Caño largo. Latiguillos de alimentación flexibles G3/8.

06220301 **119,00**
06220301D **141,00**



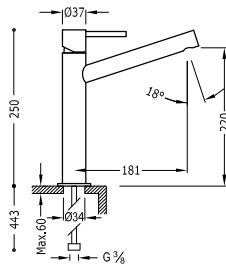

Grifo monomando alto para lavabo
Caño largo. Latiguillos de alimentación flexibles G3/8.

06220601 **207,00**

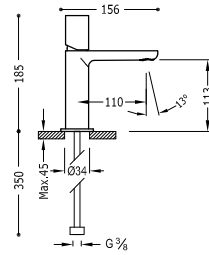

Grifo monomando para lavabo
Latiguillos de alimentación flexibles G3/8.

06110302 **121,00**
06110302D **143,00**

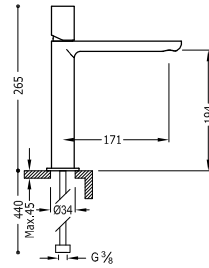

Grifo monomando alto para lavabo
Latiguillos de alimentación flexibles G3/8.

06120304 **207,00**

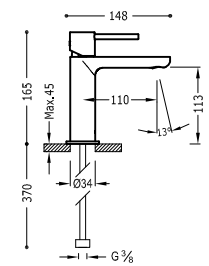

Grifo monomando para lavabo
Latiguillos de alimentación flexibles G3/8.

06210302 **121,00**
06210302D **143,00**

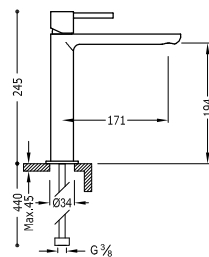

Grifo monomando alto para lavabo
Latiguillos de alimentación flexibles G3/8.

06220304 **207,00**



TOUCH-TRES

EL GRIFO ELECTRÓNICO SENSIBLE AL TACTO

Se cierra automáticamente a los 10 segundos o bien cuando se vuelve a tocar.

SÓLO TOCAR
(NO PULSAR)



Grifo electrónico de 1 agua para lavabo
Sistema sensible al tacto TOUCH-TRES.

06144701

265,00

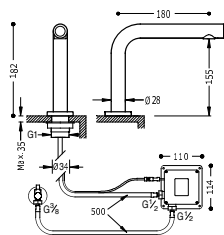

Grifo electrónico con sistema premezclador para lavabo
Sistema sensible al tacto TOUCH-TRES. Incluye una válvula mezcladora de 2 aguas con tubos flexibles (ref.: 19250730).

06144801

295,00

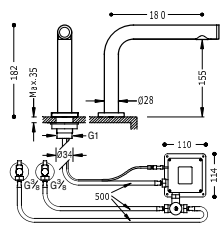

Grifo de 1 agua para lavabo
Con latiguillo de alimentación flexible G3/8.

20050301

95,00

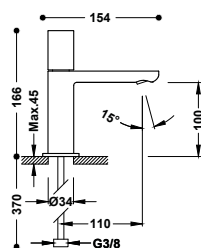

Grifo monomando empotrado para lavabo

06230011

240,00

Cuerpo empotrado indivisible con amortiguadores acústicos. Junta antihumedad. Caño de 180 mm.

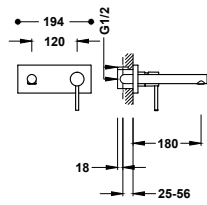

29902801

Grifo monomando empotrado para lavabo

06230012

250,00

Cuerpo empotrado indivisible con amortiguadores acústicos. Junta antihumedad. Caño de 240 mm.

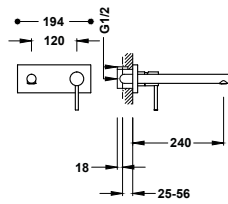

29902801

Grifo monomando empotrado para lavabo

06230001

220,00

Cuerpo empotrado indivisible con amortiguadores acústicos. Junta antihumedad. Caño de 177 mm.

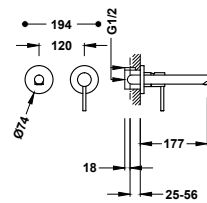

29902801

Grifo monomando empotrado para lavabo

06230002

230,00

Cuerpo empotrado indivisible con amortiguadores acústicos. Junta antihumedad. Caño de 237 mm.

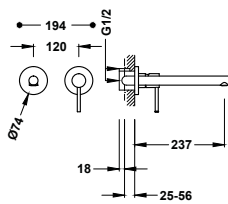

29902801

GRIFOS PARA BIDÉ

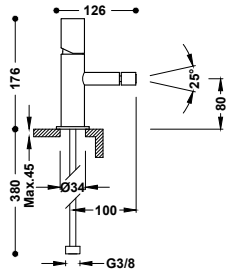

Grifo monomando para bidé
Rótula orientable. Latiguillos de alimentación flexibles G3/8.

06112001 **107,00**
06112001D **129,00**



910719005

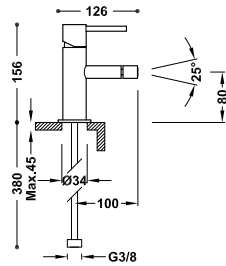

Grifo monomando para bidé
Rótula orientable. Latiguillos de alimentación flexibles G3/8.

06212001 **107,00**
06212001D **129,00**



910719005

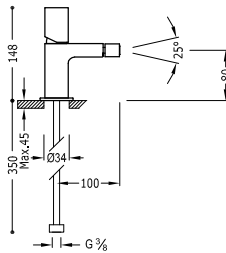

Grifo monomando para bidé
Rótula orientable. Latiguillos de alimentación flexibles G3/8.

06122001 **124,00**
06122001D **146,00**



9130190

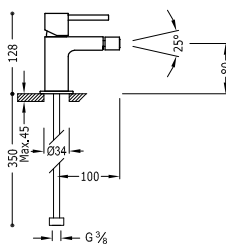

Grifo monomando para bidé
Rótula orientable. Latiguillos de alimentación flexibles G3/8.

06222001 **124,00**
06222001D **146,00**



9130190

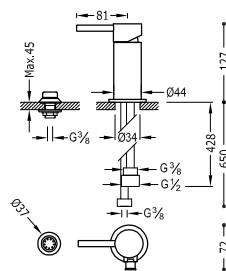

Grifo monomando para bidé con transferencia a duchita
Con inversor para duchita. Latiguillos de alimentación flexibles G3/8.

06213001 **125,00**



9134592

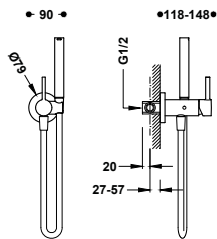

Grifo monomando empotrado con ducha para inodoro

Con agua fría o caliente. Ducha de mano con racor limitador a 5 l/min. y sistema antigoteo. Soporte fijo para la ducha de mano instalable a derecha o izquierda. Flexo satinado.

134123

178,00

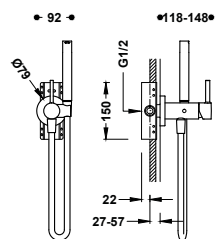

Grifo monomando empotrado con ducha para inodoro

Opción para paredes de Pladur. Con agua fría o caliente. Ducha de mano con racor limitador a 5 l/min. y sistema antigoteo. Soporte fijo para la ducha de mano instalable a derecha o izquierda. Flexo satinado.

134122

218,00



Accesorio porta toallas para grifo con ducha para inodoro

Soporte instalable a derecha o izquierda (para ref.: 134122, 134123, 181122, 181123, 181222, 181223, 20522201, 20522301). Long: 180 mm.

03412401

35,00

GRIFOS MURALES

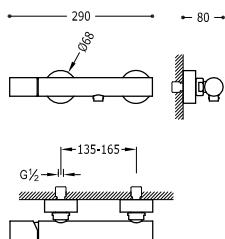

Grifo monomando mural para ducha

Ducha de mano anticalcárea. Soporte orientable para ducha de mano. Flexo satinado.

06116701

205,00

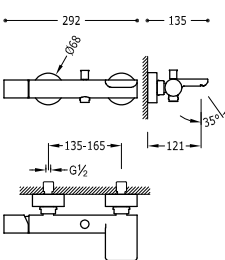

Grifo monomando mural para bañera y ducha

Ducha de mano anticalcárea. Caño cerrado con salida del agua en cascada. Soporte orientable para ducha de mano. Flexo satinado.

06117001

225,00



GRIFOS EMPOTRADOS RAPID-BOX

Pieza vista para caja empotrada de 1 vía Rapid-box

06227810

75,00

Sólo parte vista. Incluye placa embellecedora, mando, casquillo y tornillo de fijación oculto. Caja empotrada no incluida.

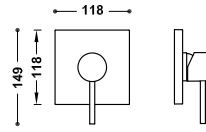

Caja empotrada de 1 vía Rapid-box con grifo monomando para ducha

20827810

80,00 N

Pieza vista para caja empotrada de 2 vías Rapid-box

06228110

95,00

Sólo parte vista. Incluye placa embellecedora, mando, volante distribuidor y tornillo de fijación oculto. Caja empotrada no incluida.

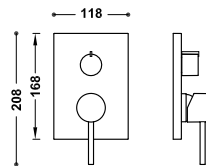

Caja empotrada de 2 vías Rapid-box con grifo monomando para ducha y bañera

20828110

90,00 N

Kit de grifo monomando empotrado de 2 vías Rapid-box para ducha

06228004

414,00

- Cuerpo empotrado incluido.
- Distribuidor cerámico de 2 vías.
- Brazo a pared con rociador de ducha orientable y de acero inoxidable: Ø 250 mm.
- Soporte para ducha de mano con toma de agua a pared.
- Ducha de mano anticalcárea de latón.
- Flexo satinado.

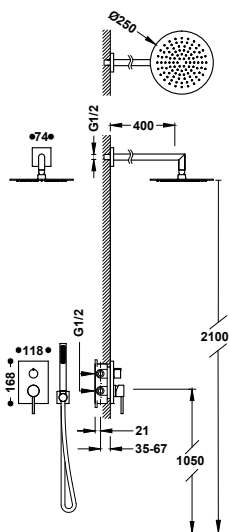

29903508

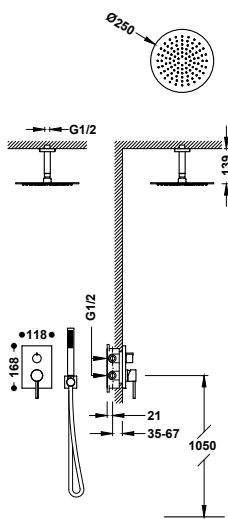

Kit de grifo monomando empotrado de 2 vías Rapid-box para ducha

06228003

364,00

- Cuerpo empotrado incluido.
- Distribuidor cerámico de 2 vías.
- Brazo a techo con rociador de ducha orientable y de acero inoxidable: Ø 250 mm.
- Soporte para ducha de mano con toma de agua a pared.
- Ducha de mano anticalcárea de latón.
- Flexo satinado.



29903508

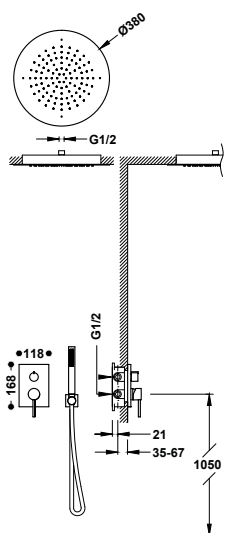

Kit de grifo monomando empotrado de 2 vías Rapid-box para ducha

06228005

820,00

- Cuerpo empotrado incluido.
- Distribuidor cerámico de 2 vías.
- Rociador empotrado a techo de acero inoxidable: Ø 380 mm.
- Soporte para ducha de mano con toma de agua a pared.
- Ducha de mano anticalcárea de latón.
- Flexo satinado.



29903508

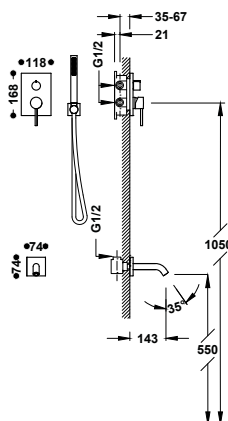

Kit de grifo monomando empotrado de 2 vías Rapid-box para bañera y ducha

06228006

333,00

- Cuerpo empotrado incluido.
- Distribuidor cerámico de 2 vías.
- Caño fijo de bañera a pared.
- Soporte para ducha de mano con toma de agua a pared.
- Ducha de mano anticalcárea de latón.
- Flexo satinado.



29903508

GRIFOS EMPOTRADOS

Grifo monomando empotrado de 1 vía para ducha
Cuerpo empotrado incluido.

06217702

110,00

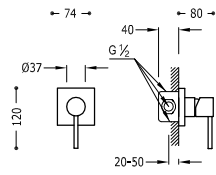

Grifo monomando empotrado de 2 vías para bañera y ducha
Cuerpo empotrado incluido. Inversor de 2 vías.

06218002

170,00

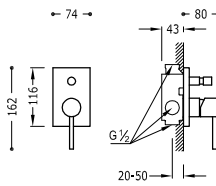

Kit de grifo monomando empotrado de 2 vías para ducha

06298004

427,00

- Cuerpo empotrado incluido.
- Inversor de 2 vías.
- Brazo a pared con rociador de ducha orientable y de acero inoxidable: Ø 250 mm.
- Soporte para ducha de mano con toma de agua a pared.
- Ducha de mano anticalcárea.
- Flexo satinado.

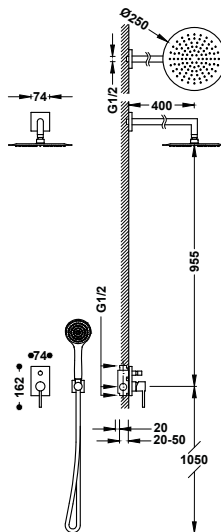

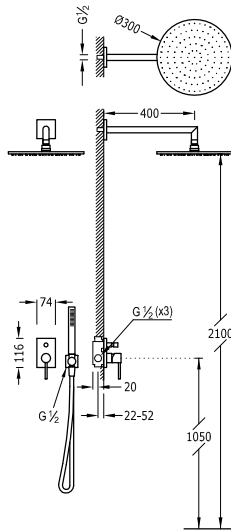

Kit de grifo monomando empotrado de 2 vías para ducha

06298001

489,00

- Cuerpo empotrado incluido.
- Inversor de 2 vías.
- Brazo a pared con rociador de ducha orientable y de acero inoxidable: Ø 300 mm.
- Soporte para ducha de mano con toma de agua a pared.
- Ducha de mano anticalcárea de latón.
- Flexo satinado.



9130190

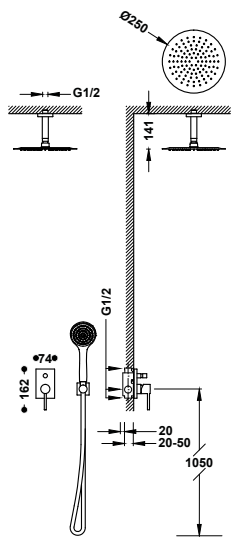

Kit de grifo monomando empotrado de 2 vías para ducha

06218081

394,00

- Cuerpo empotrado incluido.
- Inversor de 2 vías.
- Brazo a techo con rociador de ducha orientable y de acero inoxidable: Ø 250 mm.
- Soporte para ducha de mano con toma de agua a pared.
- Ducha de mano anticalcárea.
- Flexo satinado.



9130190

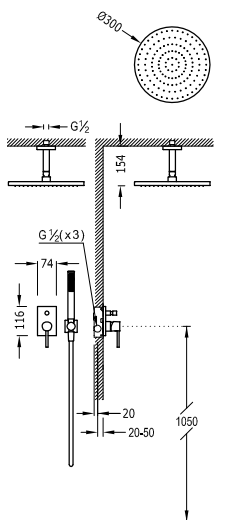

Kit de grifo monomando empotrado de 2 vías para ducha

06218080

456,00

- Cuerpo empotrado incluido.
- Inversor de 2 vías.
- Brazo a techo con rociador de ducha orientable y de acero inoxidable: Ø 300 mm.
- Soporte para ducha de mano con toma de agua a pared.
- Ducha de mano anticalcárea de latón.
- Flexo satinado.



9130190

GRIFOS PARA BAÑERA

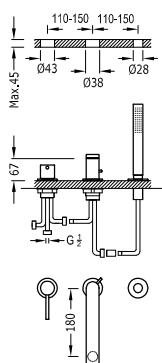

Grifo monomando para borde de bañera

06216103

370,00

- Inversor integrado en el caño de bañera.
- Ducha de mano anticalcárea de latón.
- Caño de bañera de 180 mm. Caudal: 3 bar - 16 l/m.
- Kit depósito opcional no incluido ref.: 20324501.

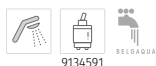

Depósito para grifería de borde de bañera

20324501

395,00

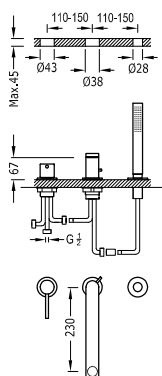

Grifo monomando para borde de bañera

06216102

380,00

- Inversor integrado en el caño de bañera.
- Ducha de mano anticalcárea de latón.
- Caño de bañera de 230 mm. Caudal: 3 bar - 16 l/m.
- Kit depósito opcional no incluido ref.: 20324501.

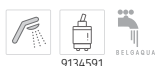

Depósito para grifería de borde de bañera

20324501

395,00

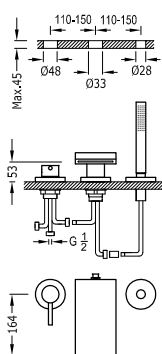

Grifo monomando para borde de bañera

162161

812,00

- Inversor integrado en el caño de bañera.
- Ducha de mano anticalcárea de latón.
- Caño de bañera con salida del agua en cascada. Caudal: 3 bar - 17 l/m.
- Kit depósito opcional no incluido ref.: 162245.



Depósito para grifería de borde de bañera

162245

395,00

GRIFOS TERMOSTÁTICOS MURALES

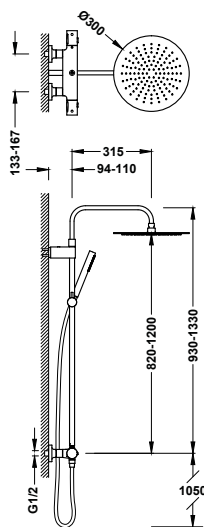

Conjunto de grifo termostático mural Over-wall de 2 vías para ducha

19039302

563,00

- Con inversor integrado en el regulador de caudal.
- Volante redondo.
- Barra de ducha telescópica.
- Rociador de ducha orientable de acero inoxidable: Ø 300 mm.
- Soporte deslizante y orientable para ducha de mano.
- Ducha de mano anticalcárea de latón.
- Flexo satinado.

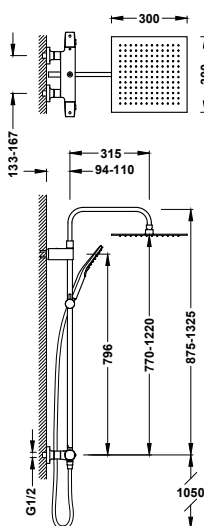

Conjunto de grifo termostático mural Over-wall de 2 vías para ducha

19038702

592,00

- Con inversor integrado en el regulador de caudal.
- Volante con bordes redondeados.
- Barra de ducha telescópica.
- Rociador de ducha orientable de acero inoxidable: 300x300 mm.
- Soporte deslizante y orientable para ducha de mano.
- Ducha de mano anticalcárea: 96x110 mm. (3 tipos de chorro).
- Flexo satinado.



GRIFOS TERMOSTÁTICOS EMPOTRADOS

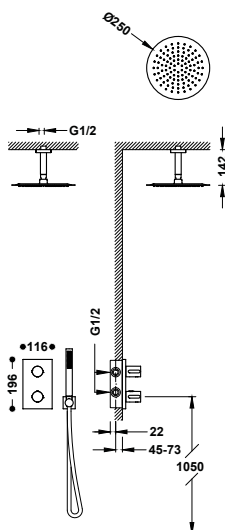

Kit de grifo termostático empotrado de 2 vías Therm-box para ducha

06225003

483,00

- Cuerpo empotrado incluido.
- Volante redondo con control de temperatura. Distribuidor cerámico de 2 vías.
- Brazo a techo con rociador de ducha orientable y de acero inoxidable: Ø 250 mm.
- Soporte para ducha de mano con toma de agua a pared.
- Ducha de mano anticalcárea de latón.
- Flexo satinado.

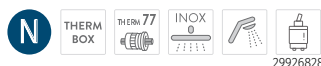

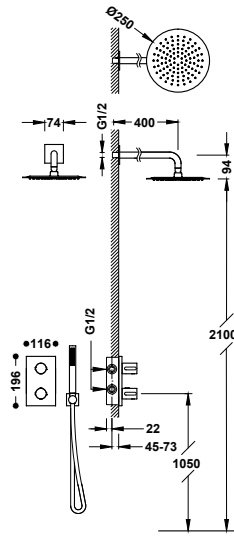

Kit de grifo termostático empotrado de 2 vías Therm-box para ducha

06225004

516,00

- Cuerpo empotrado incluido.
- Volante redondo con control de temperatura. Distribuidor cerámico de 2 vías.
- Brazo a pared con rociador de ducha orientable y de acero inoxidable: Ø 250 mm.
- Soporte para ducha de mano con toma de agua a pared.
- Ducha de mano anticalcárea de latón.
- Flexo satinado.

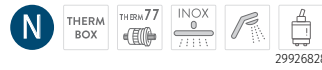

LLAVES DE PASO

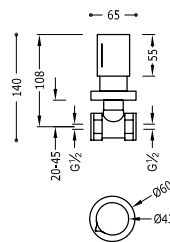

Llave de paso empotrada
Conexión a rosca hembra: 1/2".

06115501

80,00

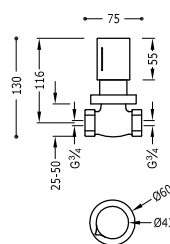

Llave de paso empotrada
Conexión a rosca hembra: 3/4".

06151101

88,00

LEX-ALP

Un diseño clásico que invita a la calma. Lex-Alp es una serie equilibrada, que funciona a la perfección y nunca pasa de moda. Eso es lo que la hace más especial.

Acabados disponibles:



CR







GRIFOS PARA LAVABO

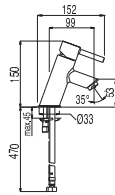

Grifo monomando inclinado para lavabo
Latiguillos de alimentación flexibles G3/8.

20310301 **84,00**
20310301D **106,00**

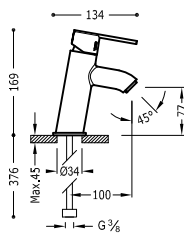

Grifo monomando inclinado para lavabo
Con aireador de fácil limpieza. Latiguillos de alimentación flexibles G3/8.

181903 **108,00**

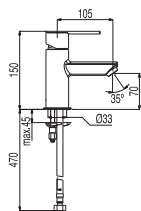

Grifo monomando para lavabo
Con aireador de fácil limpieza. Latiguillos de alimentación flexibles G3/8.

181103 **104,00**
186103 **126,00**

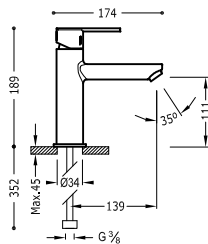

Grifo monomando para lavabo
Con aireador de fácil limpieza. Latiguillos de alimentación flexibles G3/8.

181203 **129,00**
186203 **151,00**

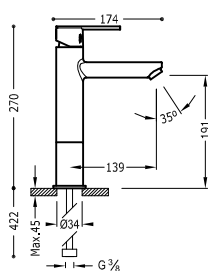

Grifo monomando alto para lavabo
Con aireador de fácil limpieza. Latiguillos de alimentación flexibles G3/8.

181217 **204,00**
186217 **226,00**



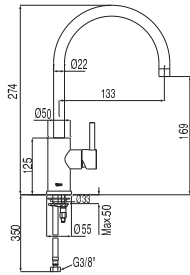

Grifo monomando con maneta lateral para lavabo
 Latiguillos de alimentación flexibles G3/8.

20370301

160,00

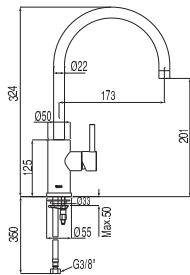

Grifo monomando alto con maneta lateral para lavabo
 Latiguillos de alimentación flexibles G3/8.

20340301

170,00

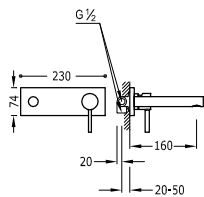

Grifo monomando empotrado para lavabo
 Cuerpo empotrado incluido e indivisible. Caño de 160 mm.

20321001

230,00

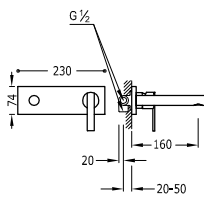

Grifo monomando empotrado para lavabo
 Cuerpo empotrado incluido e indivisible. Caño de 160 mm.

08120001

230,00

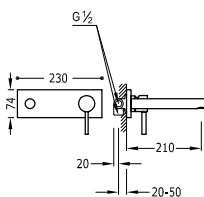

Grifo monomando empotrado para lavabo
 Cuerpo empotrado incluido e indivisible. Caño de 210 mm.

20320002

240,00



Grifo monomando empotrado para lavabo
 Cuerpo empotrado incluido e indivisible. Caño de 210 mm.

08120021

240,00

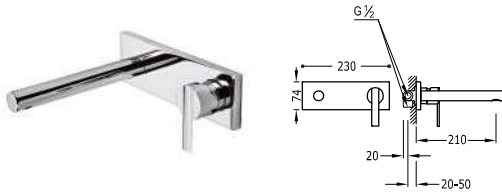

GRIFOS PARA BIDÉ

Grifo monomando para bidé
 Rótula orientable. Con aireador de fácil limpieza. Latiguillos de alimentación flexibles G3/8.

181120
 186120

107,00
 129,00

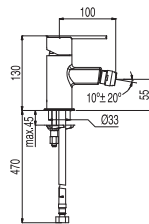

Grifo monomando inclinado para bidé
 Rótula orientable. Latiguillos de alimentación flexibles G3/8.

20312001

87,00

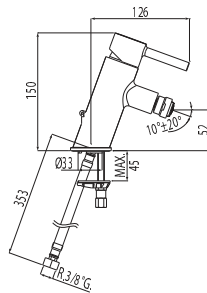

Grifo monomando inclinado para bidé
 Rótula orientable. Con aireador de fácil limpieza. Latiguillos de alimentación flexibles G3/8.

181920
 186920

111,00
 133,00

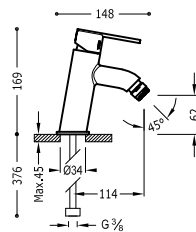

Grifo monomando con maneta lateral para bidé
 Rótula orientable. Latiguillos de alimentación flexibles G3/8.

20322401

163,00

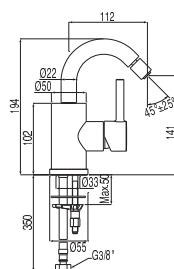

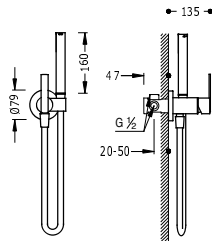

Grifo monomando empotrado con ducha para inodoro
 Con agua fría o caliente. Ducha de mano con racor limitador a 5 l/min. y sistema antigoteo. Soporte fijo para la ducha de mano instalable a derecha o izquierda. Flexo satinado.

181223

176,00

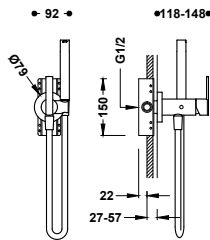

Grifo monomando empotrado con ducha para inodoro
 Opción para paredes de Pladur. Con agua fría o caliente. Ducha de mano con racor limitador a 5 l/min. y sistema antigoteo. Soporte fijo para la ducha de mano instalable a derecha o izquierda. Flexo satinado.

181222

216,00



Accesorio porta toallas para grifo con ducha para inodoro
 Soporte instalable a derecha o izquierda (para ref.: 134122, 134123, 181122, 181123, 181222, 181223, 20522201, 20522301). Long: 180 mm.

03412401

35,00

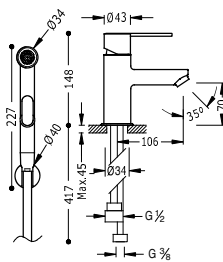

Grifo monomando para lavabo con ducha para inodoro
 Ducha de mano anticalcárea con cierre de caudal. Soporte fijo para ducha de mano. Flexo satinado. Latiguillos de alimentación flexibles G3/8.

181113

185,00

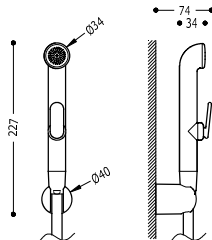

Kit de ducha para grifo monomando para inodoro
 Ducha de mano con cierre de caudal. Soporte fijo para ducha de mano. Flexo satinado. Atención: Recambio solo para bidé ref: 162113 y 181113.

29995001

36,00

GRIFOS MURALES

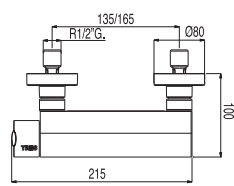

Grifo monomando mural para ducha

181468

165,00

Ducha de mano anticalcárea: Ø 100 mm. (5 tipos de chorro). Soporte orientable para ducha de mano. Flexo satinado.

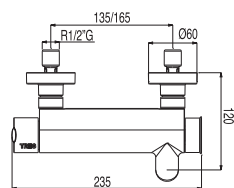

Grifo monomando mural para bañera y ducha

181474

185,00

Ducha de mano anticalcárea: Ø 100 mm. (5 tipos de chorro). Soporte orientable para ducha de mano. Flexo satinado.

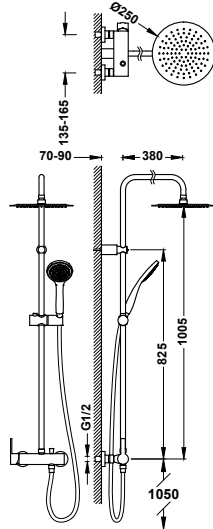

Conjunto de grifo monomando mural de 2 vías para ducha

18119102

423,00

- Rociador de ducha orientable de acero inoxidable: Ø 250 mm.
- Soporte deslizante y orientable para ducha de mano.
- Ducha de mano anticalcárea: Ø 100 mm.
- Flexo satinado.

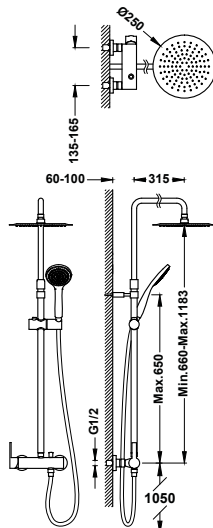

Conjunto de grifo monomando mural de 2 vías para ducha

08119703

466,00

- Rociador de ducha orientable de acero inoxidable: Ø 250 mm.
- Barra de ducha telescópica.
- Soporte deslizante y orientable para ducha de mano.
- Ducha de mano anticalcárea: Ø 100 mm.
- Flexo satinado.



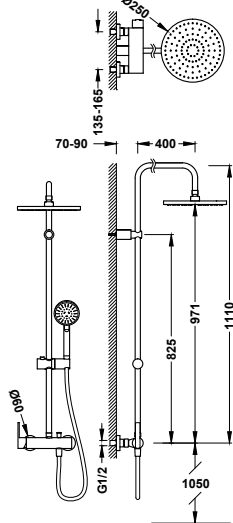

Conjunto de grifo monomando mural de 2 vías para ducha

181191

423,00

- Rociador de ducha orientable de acero inoxidable: Ø 250 mm.
- Soporte deslizante y orientable para ducha de mano.
- Ducha de mano anticalcárea: Ø 100 mm. (5 tipos de chorro).
- Flexo satinado.

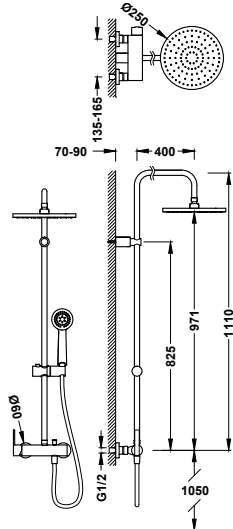

Conjunto de grifo monomando mural de 2 vías para ducha

081192

387,00

- Rociador de ducha orientable de acero inoxidable: Ø 250 mm.
- Soporte deslizante y orientable para ducha de mano.
- Ducha de mano anticalcárea: Ø 100 mm.
- Flexo metálico reforzado.

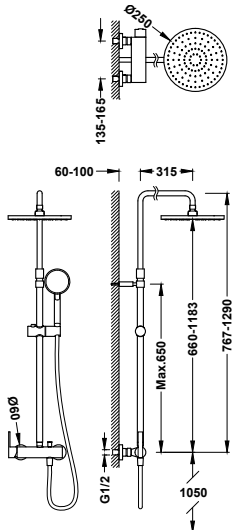

Conjunto de grifo monomando mural de 2 vías para ducha

08119702

498,00

- Rociador de ducha orientable de acero inoxidable: Ø 250 mm.
- Barra de ducha telescópica.
- Soporte deslizante y orientable para ducha de mano.
- Ducha de mano anticalcárea: Ø 100 mm. (5 tipos de chorro).
- Flexo satinado.



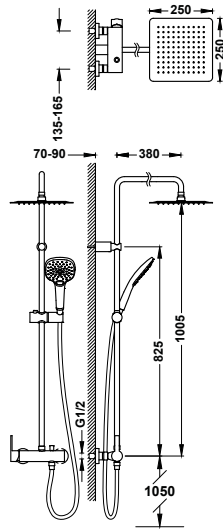

Conjunto de grifo monomando mural de 2 vías para ducha

08119302

421,00

- Rociador de ducha orientable de acero inoxidable: 250x250 mm.
- Soporte deslizante y orientable para ducha de mano.
- Ducha de mano anticalcárea: 120x120 mm. (3 tipos de chorro).
- Flexo satinado.

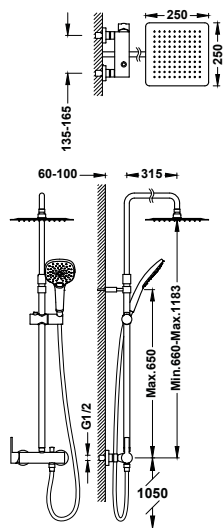

Conjunto de grifo monomando mural de 2 vías para ducha

08119704

496,00

- Rociador de ducha orientable de acero inoxidable: 250x250 mm.
- Barra de ducha telescópica.
- Soporte deslizante y orientable para ducha de mano.
- Ducha de mano anticalcárea: 120x120 mm. (3 tipos de chorro).
- Flexo satinado.

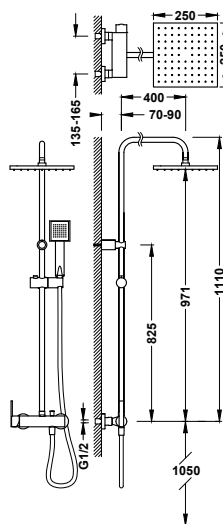

Conjunto de grifo monomando mural de 2 vías para ducha

08119301

414,00

- Rociador de ducha orientable de acero inoxidable: 250x250 mm.
- Soporte deslizante y orientable para ducha de mano.
- Ducha de mano anticalcárea: 80x80 mm.
- Flexo satinado.



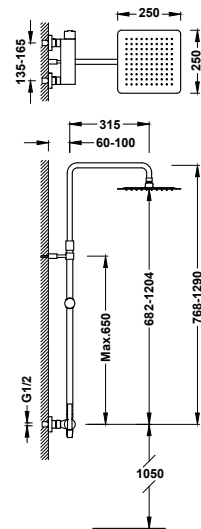

Conjunto de grifo monomando mural de 2 vías para ducha

08119701

489,00

- Rociador de ducha orientable de acero inoxidable: 250x250 mm.
- Barra de ducha telescópica.
- Soporte deslizante y orientable para ducha de mano.
- Ducha de mano anticalcárea.
- Flexo satinado.



GRIFOS EMPOTRADOS

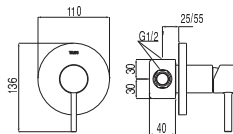

Grifo monomando empotrado de 1 vía para ducha

20317701

95,00

Cuerpo empotrado incluido.

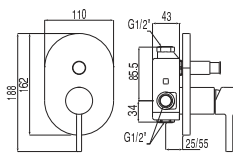

Grifo monomando empotrado de 2 vías para bañera y ducha

20318001

145,00

Cuerpo empotrado incluido. Inversor de 2 vías.

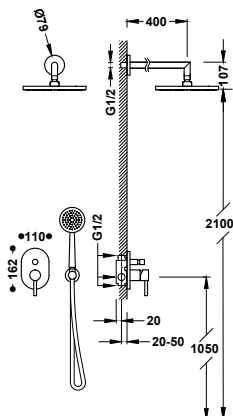
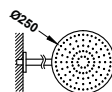

Kit de grifo monomando empotrado de 2 vías para ducha

20318002

395,00

- Cuerpo empotrado incluido.
- Inversor de 2 vías.
- Brazo a pared con rociador de ducha orientable y de acero inoxidable: Ø 250 mm.
- Soporte para ducha de mano con toma de agua a pared.
- Ducha de mano anticalcárea: Ø 100 mm.
- Flexo satinado.



GRIFOS PARA BAÑERA

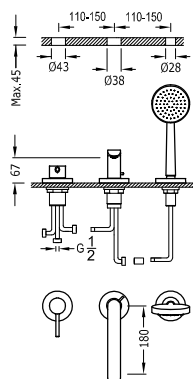

Grifo monomando para borde de bañera

20316102

340,00

- Inversor integrado en el caño de bañera.
- Ducha de mano anticalcárea: Ø 100 mm.
- Caño de bañera de 180 mm. Caudal: 3 bar - 16 l/m.
- Kit depósito opcional no incluido ref.: 20324501.



Depósito para grifería de borde de bañera

20324501

395,00

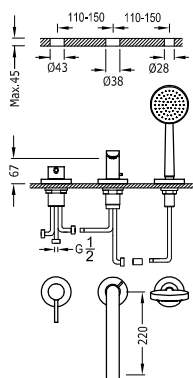

Grifo monomando para borde de bañera

20316101

350,00

- Inversor integrado en el caño de bañera.
- Ducha de mano anticalcárea: Ø 100 mm.
- Caño de bañera de 220 mm. Caudal: 3 bar - 16 l/m.
- Kit depósito opcional no incluido ref.: 20324501.



Depósito para grifería de borde de bañera

20324501

395,00

GRIFOS TERMOSTÁTICOS MURALES

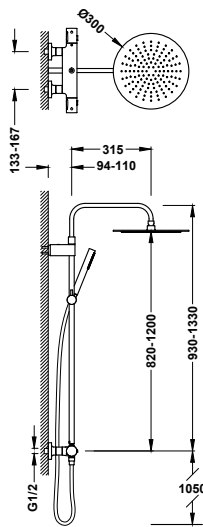

Conjunto de grifo termostático mural Over-wall de 2 vías para ducha

19039302

563,00

- Con inversor integrado en el regulador de caudal.
- Volante redondo.
- Barra de ducha telescópica.
- Rociador de ducha orientable de acero inoxidable: Ø 300 mm.
- Soporte deslizante y orientable para ducha de mano.
- Ducha de mano anticalcárea de latón.
- Flexo satinado.



29916832

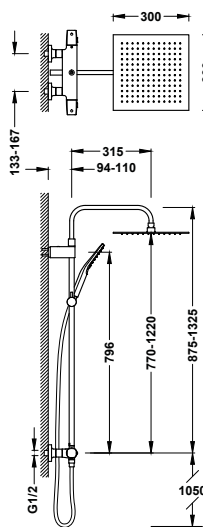

Conjunto de grifo termostático mural Over-wall de 2 vías para ducha

19038702

592,00

- Con inversor integrado en el regulador de caudal.
- Volante con bordes redondeados.
- Barra de ducha telescópica.
- Rociador de ducha orientable de acero inoxidable: 300x300 mm.
- Soporte deslizante y orientable para ducha de mano.
- Ducha de mano anticalcárea: 96x110 mm. (3 tipos de chorro).
- Flexo satinado.



29916834

GRIFOS TERMOSTÁTICOS EMPOTRADOS

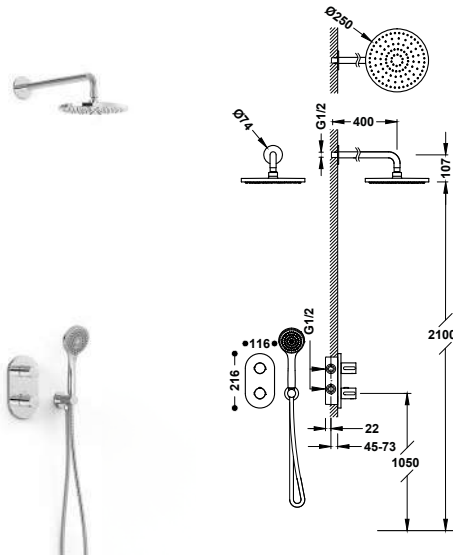

Kit de grifo termostático empotrado de 2 vías Therm-box para ducha

21525004

455,00

- Cuerpo empotrado incluido.
- Volante redondo de ABS con control de temperatura. Distribuidor cerámico de 2 vías.
- Brazo a pared con rociador de ducha orientable: Ø 250 mm.
- Soporte para ducha de mano con toma de agua a pared.
- Ducha de mano anticalcárea.
- Flexo metálico.



LLAVES DE PASO

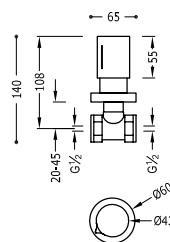

Llave de paso empotrada
Conexión a rosca hembra: 1/2".

06115501

80,00

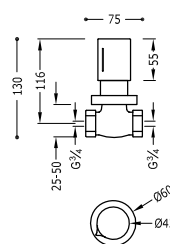

Llave de paso empotrada
Conexión a rosca hembra: 3/4".

06151101

88,00

CLASS

La serie Class nace con el claro objetivo de ofrecer todo el bienestar y confort posible en el cuarto de baño. Es una serie de líneas actuales que encaja a la perfección en todo tipo de espacios, tanto reducidos como amplios.

Acabados disponibles:



CR







GRIFOS PARA LAVABO

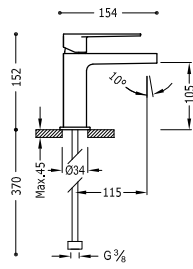

Grifo monomando para lavabo
Latiguillos de alimentación flexibles G3/8.

20510301 **102,00**
20510301D **124,00**

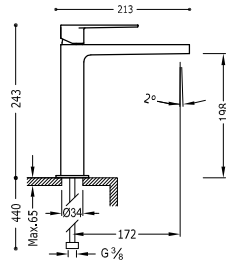

Grifo monomando alto para lavabo
Latiguillos de alimentación flexibles G3/8.

20510303 **200,00**

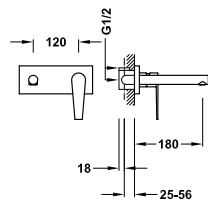

Grifo monomando empotrado para lavabo
Cuerpo empotrado indivisible con amortiguadores acústicos. Junta antihumedad. Caño de 180 mm.

20530011 **220,00**

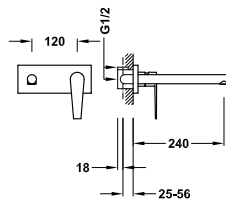

Grifo monomando empotrado para lavabo
Cuerpo empotrado indivisible con amortiguadores acústicos. Junta antihumedad. Caño de 240 mm.

20530012 **230,00**

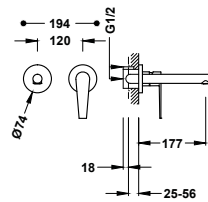

Grifo monomando empotrado para lavabo
Cuerpo empotrado indivisible con amortiguadores acústicos. Junta antihumedad. Caño de 177 mm.

20530001 **210,00**

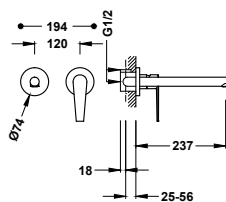

Grifo monomando empotrado para lavabo
Cuerpo empotrado indivisible con amortiguadores acústicos. Junta antihumedad. Caño de 237 mm.

20530002 **220,00**



GRIFOS PARA BIDÉ

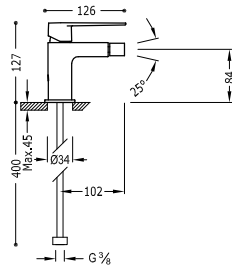

Grifo monomando para bidé

Rótula orientable. Latiguillos de alimentación flexibles G3/8.

- 20512001
- 20512001D

105,00
127,00



GRIFOS MURALES

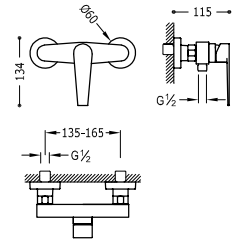

Grifo monomando mural para ducha

Ducha de mano anticalcárea. Soporte orientable para ducha de mano. Flexo satinado.

- 20516701

130,00

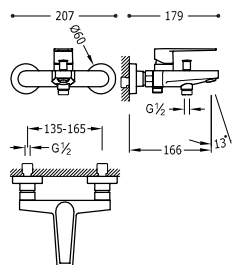

Grifo monomando mural para bañera y ducha

Ducha de mano anticalcárea. Soporte orientable para ducha de mano. Flexo satinado.

- 20517001

150,00



GRIFOS EMPOTRADOS RAPID-BOX

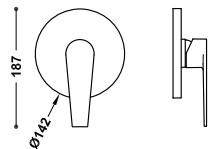

Pieza vista para caja empotrada de 1 vía Rapid-box

Sólo parte vista. Incluye placa embellecedora, mando, casquillo y tornillo de fijación oculto. Caja empotrada no incluida.

- 20527810

75,00



Caja empotrada de 1 vía Rapid-box con grifo monomando para ducha

- 20827810

80,00

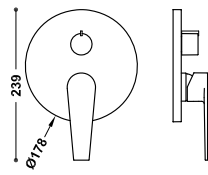

Pieza vista para caja empotrada de 2 vías Rapid-box
 Sólo parte vista. Incluye placa embellecedora, mando, volante distribuidor y tornillo de fijación oculto. **Caja empotrada no incluida.**

20528110 **95,00**



Caja empotrada de 2 vías Rapid-box con grifo monomando para ducha y bañera

20828110 **90,00** N

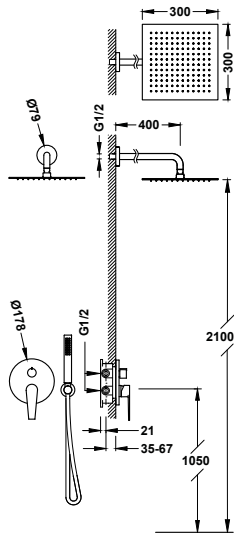

Kit de grifo monomando empotrado de 2 vías Rapid-box para ducha

20528004 **419,00**

- Cuerpo empotrado incluido.
- Distribuidor cerámico de 2 vías.
- Brazo a pared con rociador de ducha orientable y de acero inoxidable: 300x300 mm.
- Soporte para ducha de mano con toma de agua a pared.
- Ducha de mano anticalcárea.
- Flexo satinado.

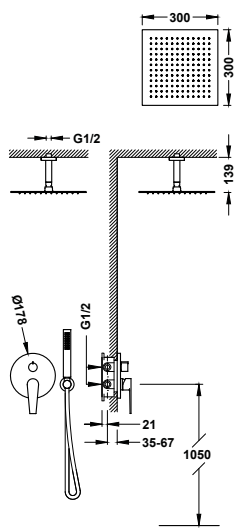
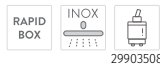

Kit de grifo monomando empotrado de 2 vías Rapid-box para ducha

20528003 **400,00**

- Cuerpo empotrado incluido.
- Distribuidor cerámico de 2 vías.
- Brazo a techo con rociador de ducha orientable y de acero inoxidable: 300x300 mm.
- Soporte para ducha de mano con toma de agua a pared.
- Ducha de mano anticalcárea.
- Flexo satinado.



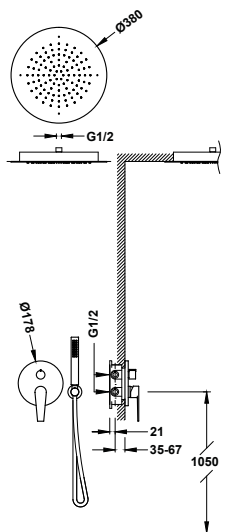

Kit de grifo monomando empotrado de 2 vías Rapid-box para ducha

20528005

806,00

- Cuerpo empotrado incluido.
- Distribuidor cerámico de 2 vías.
- Rociador de ducha empotrado a techo de acero inoxidable: Ø 380 mm.
- Soporte para ducha de mano con toma de agua a pared.
- Ducha de mano anticalcárea.
- Flexo satinado.



Kit de grifo monomando empotrado de 2 vías Rapid-box para bañera y ducha

20528006

319,00

- Cuerpo empotrado incluido.
- Distribuidor cerámico de 2 vías.
- Caño fijo de bañera a pared.
- Soporte para ducha de mano con toma de agua a pared.
- Ducha de mano anticalcárea.
- Flexo satinado.

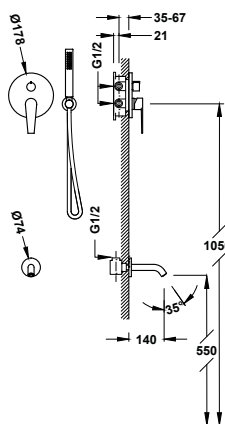

GRIFOS EMPOTRADOS

Grifo monomando empotrado de 1 vía para ducha

20517701

92,00

Cuerpo empotrado incluido.

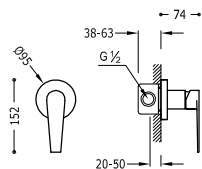

Grifo monomando empotrado de 2 vías para bañera y ducha

20518001

132,00

Cuerpo empotrado incluido. Inversor de 2 vías.

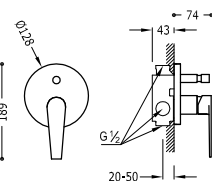

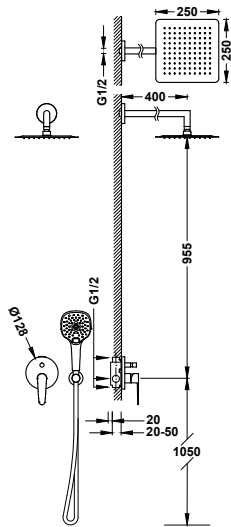

Kit de grifo monomando empotrado de 2 vías para ducha

20518006

410,00

- Cuerpo empotrado incluido.
- Inversor de 2 vías.
- Brazo a pared con rociador de ducha orientable y de acero inoxidable: 250x250 mm.
- Soporte para ducha de mano con toma de agua a pared.
- Ducha de mano anticalcárea: 120x120 mm. (3 tipos de chorro).
- Flexo satinado.

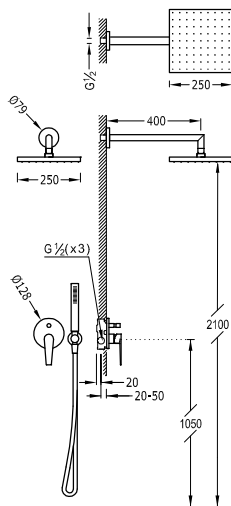

Kit de grifo monomando empotrado de 2 vías para ducha

20518002

405,00

- Cuerpo empotrado incluido.
- Inversor de 2 vías.
- Brazo a pared con rociador de ducha orientable y de acero inoxidable: 250x250 mm.
- Soporte para ducha de mano con toma de agua a pared.
- Ducha de mano anticalcárea.
- Flexo satinado.

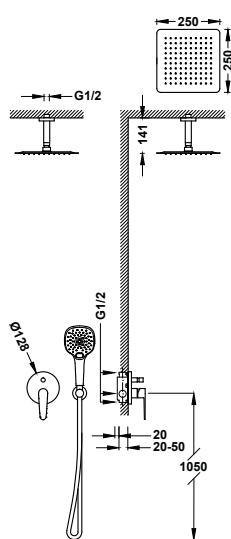

Kit de grifo monomando empotrado de 2 vías para ducha

20518007

384,00

- Cuerpo empotrado incluido.
- Inversor de 2 vías.
- Brazo a techo con rociador de ducha orientable y de acero inoxidable: 250x250 mm.
- Soporte para ducha de mano con toma de agua a pared.
- Ducha de mano anticalcárea: 120x120 mm. (3 tipos de chorro).
- Flexo satinado.



GRIFOS PARA BAÑERA

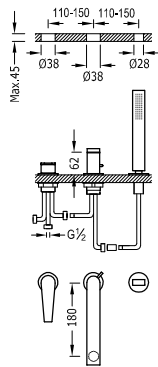

Grifo monomando para borde de bañera

20516103

350,00

- Inversor integrado en el caño de bañera.
- Ducha de mano anticalcárea.
- Caño de bañera de 180 mm. Caudal: 3 bar - 13 l/m.
- Kit depósito opcional no incluido ref.: 20024501.



Depósito para grifería de borde de bañera

20024501

395,00

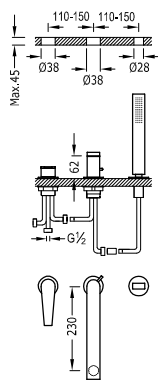

Grifo monomando para borde de bañera

20516101

360,00

- Inversor integrado en el caño de bañera.
- Ducha de mano anticalcárea.
- Caño de bañera de 230 mm. Caudal: 3 bar - 13 l/m.
- Kit depósito opcional no incluido ref.: 20024501.



Depósito para grifería de borde de bañera

20024501

395,00

GRIFOS TERMOSTÁTICOS MURALES

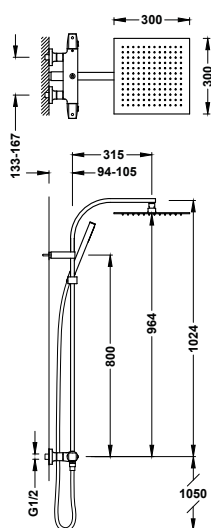

Conjunto de grifo termostático mural Over-wall de 2 vías para ducha

19039305

595,00

- Con inversor integrado en el regulador de caudal.
- Volante cuadrado-redondo.
- Rociador de ducha orientable de acero inoxidable: 300x300 mm.
- Soporte deslizante y orientable para ducha de mano.
- Ducha de mano anticalcárea de latón.
- Flexo satinado.



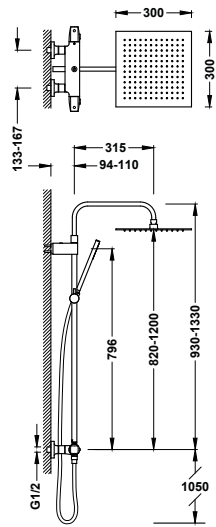

Conjunto de grifo termostático mural Over-wall de 2 vías para ducha

19039307

598,00

- Con inversor integrado en el regulador de caudal.
- Volante cuadrado-redondo.
- Barra de ducha telescópica.
- Rociador de ducha orientable de acero inoxidable: 300x300 mm.
- Soporte deslizante y orientable para ducha de mano.
- Ducha de mano anticalcárea de latón.
- Flexo satinado.



GRIFOS TERMOSTÁTICOS EMPOTRADOS

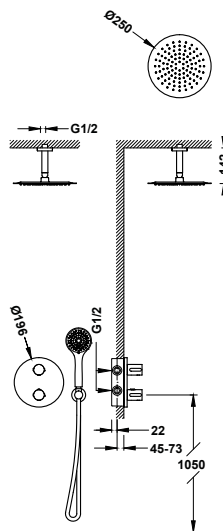

Kit de grifo termostático empotrado de 2 vías Therm-box para ducha

20425003

439,00

- Cuerpo empotrado incluido.
- Volante redondo de ABS con control de temperatura. Distribuidor cerámico de 2 vías.
- Brazo a techo con rociador de ducha orientable y de acero inoxidable: Ø 250 mm.
- Soporte para ducha de mano con toma de agua a pared.
- Ducha de mano anticalcárea: Ø 100 mm. (3 tipos de chorro).
- Flexo satinado.

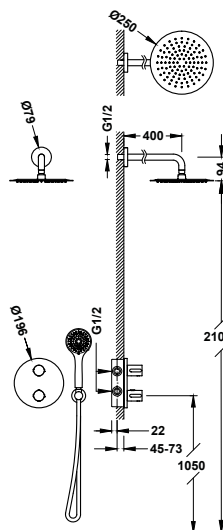

Kit de grifo termostático empotrado de 2 vías Therm-box para ducha

20425004

465,00

- Cuerpo empotrado incluido.
- Volante redondo de ABS con control de temperatura. Distribuidor cerámico de 2 vías.
- Brazo a pared con rociador de ducha orientable y de acero inoxidable: Ø 250 mm.
- Soporte para ducha de mano con toma de agua a pared.
- Ducha de mano anticalcárea: Ø 100 mm. (3 tipos de chorro).
- Flexo satinado.



FLAT

El punto fuerte de Flat reside en su sencillez. Esbelta, cómoda y funcional, esta serie da como resultado un baño asequible a la vez que especial. Flat es la sencillez que destaca.

Acabados disponibles:



CR







GRIFOS PARA LAVABO

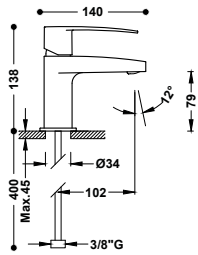

Grifo monomando para lavabo
Latiguillos de alimentación flexibles G3/8.

20410301 **87,00**
20410301D **109,00**

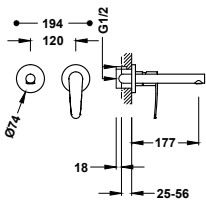

Grifo monomando empotrado para lavabo
Cuerpo empotrado indivisible con amortiguadores acústicos. Junta antihumedad. Caño de 177 mm.

20430001 **200,00**

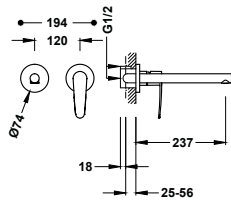

Grifo monomando empotrado para lavabo
Cuerpo empotrado indivisible con amortiguadores acústicos. Junta antihumedad. Caño de 237 mm.

20430002 **210,00**



GRIFOS PARA BIDÉ

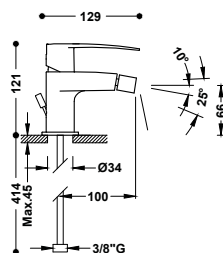

Grifo monomando para bidé
Latiguillos de alimentación flexibles G3/8.

20412001 **90,00**
20412001D **112,00**



GRIFOS MURALES

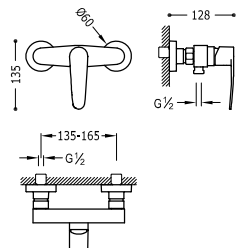

Grifo monomando mural para ducha

Ducha de mano anticalcárea. Soporte orientable para ducha de mano. Flexo satinado.

20416701

125,00

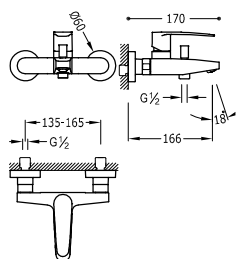

Grifo monomando mural para bañera y ducha

Ducha de mano anticalcárea. Soporte orientable para ducha de mano. Flexo satinado.

20417001

145,00



GRIFOS EMPOTRADOS RAPID-BOX

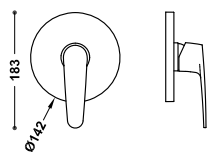

Pieza vista para caja empotrada de 1 vía Rapid-box

Sólo parte vista. Incluye placa embellecedora, mando, casquillo y tornillo de fijación oculto. **Caja empotrada no incluida.**

20427810

60,00



Caja empotrada de 1 vía Rapid-box con grifo monomando para ducha

20827810

80,00 **N**

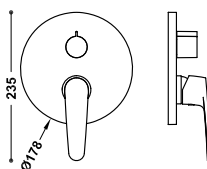

Pieza vista para caja empotrada de 2 vías Rapid-box

Sólo parte vista. Incluye placa embellecedora, mando, volante distribuidor y tornillo de fijación oculto. **Caja empotrada no incluida.**

20428110

75,00



Caja empotrada de 2 vías Rapid-box con grifo monomando para ducha y bañera

20828110

90,00 **N**

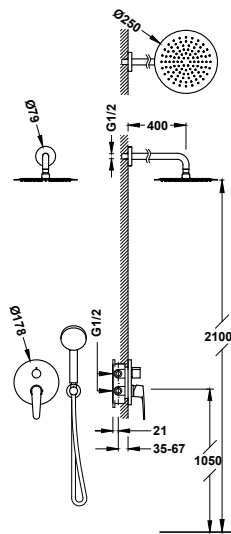

Kit de grifo monomando empotrado de 2 vías Rapid-box para ducha

20428004

357,00

- Cuerpo empotrado incluido.
- Distribuidor cerámico de 2 vías.
- Brazo a pared con rociador de ducha orientable y de acero inoxidable: Ø 250 mm.
- Soporte para ducha de mano con toma de agua a pared.
- Ducha de mano anticalcárea: Ø 110 mm.
- Flexo satinado.

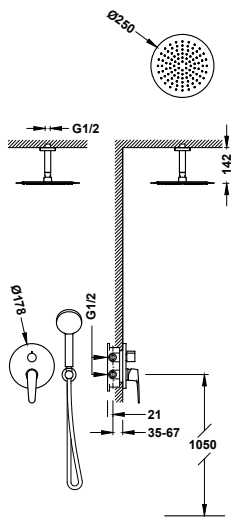

Kit de grifo monomando empotrado de 2 vías Rapid-box para ducha

20428003

338,00

- Cuerpo empotrado incluido.
- Distribuidor cerámico de 2 vías.
- Brazo a techo con rociador de ducha orientable y de acero inoxidable: Ø 250 mm.
- Soporte para ducha de mano con toma de agua a pared.
- Ducha de mano anticalcárea: Ø 110 mm.
- Flexo satinado.

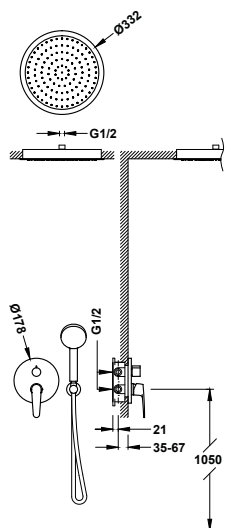

Kit de grifo monomando empotrado de 2 vías Rapid-box para ducha

20428005

599,00

- Cuerpo empotrado incluido.
- Distribuidor cerámico de 2 vías.
- Rociador empotrado a techo de latón: Ø 332 mm.
- Soporte para ducha de mano con toma de agua a pared.
- Ducha de mano anticalcárea: Ø 110 mm.
- Flexo satinado.



Kit de grifo monomando empotrado de 2 vías Rapid-box para bañera y ducha

20428006

304,00

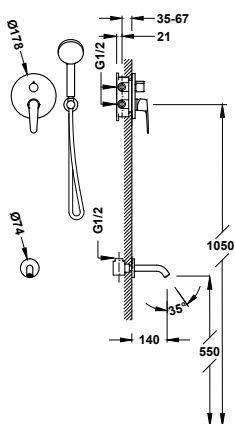

- Cuerpo empotrado incluido.
- Distribuidor cerámico de 2 vías.
- Caño fijo de bañera a pared.
- Soporte para ducha de mano con toma de agua a pared.
- Ducha de mano anticalcárea: Ø 110 mm.
- Flexo satinado.



GRIFOS EMPOTRADOS

Grifo monomando empotrado de 1 vía para ducha

20417701

92,00

Cuerpo empotrado incluido.

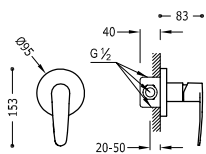

Grifo monomando empotrado de 2 vías para bañera y ducha

20418001

132,00

Cuerpo empotrado incluido. Inversor de 2 vías.

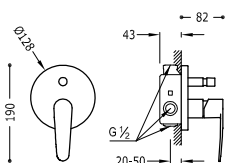

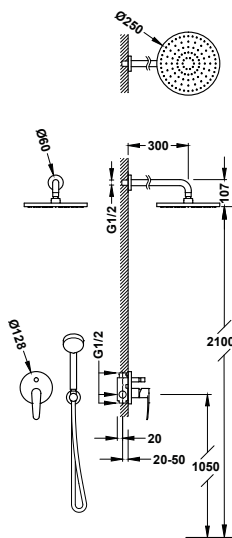

Kit de grifo monomando empotrado de 2 vías para ducha

20418002

369,00

- Cuerpo empotrado incluido.
- Inversor de 2 vías.
- Brazo a pared con rociador de ducha orientable y de acero inoxidable: Ø 250 mm.
- Soporte para ducha de mano con toma de agua a pared.
- Ducha de mano anticalcárea: Ø 100 mm.
- Flexo satinado.

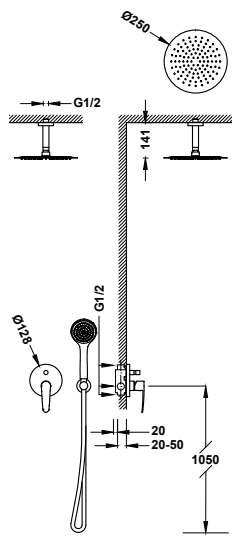

Kit de grifo monomando empotrado de 2 vías para ducha

20418005

356,00

- Cuerpo empotrado incluido.
- Inversor de 2 vías.
- Brazo a techo con rociador de ducha orientable y de acero inoxidable: Ø 250 mm.
- Soporte para ducha de mano con toma de agua a pared.
- Ducha de mano anticalcárea: Ø 100 mm.
- Flexo satinado.

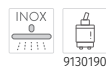

GRIFOS TERMOSTÁTICOS MURALES

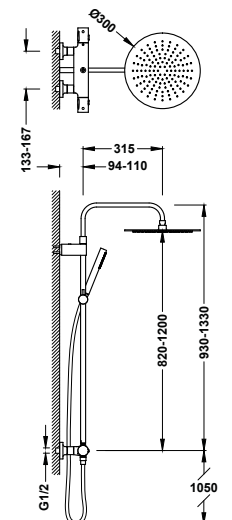

Conjunto de grifo termostático mural Over-wall de 2 vías para ducha

19039302

563,00

- Con inversor integrado en el regulador de caudal.
- Volante redondo.
- Barra de ducha telescópica.
- Rociador de ducha orientable de acero inoxidable: Ø 300 mm.
- Soporte deslizante y orientable para ducha de mano.
- Ducha de mano anticalcárea de latón.
- Flexo satinado.



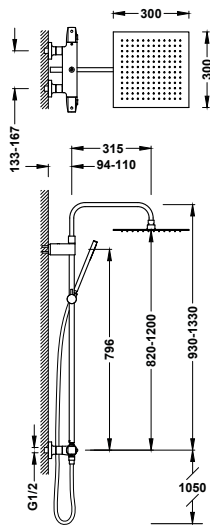

Conjunto de grifo termostático mural Over-wall de 2 vías para ducha

19039307

598,00

- Con inversor integrado en el regulador de caudal.
- Volante cuadrado-redondo.
- Barra de ducha telescópica.
- Rociador de ducha orientable de acero inoxidable: 300x300 mm.
- Soporte deslizante y orientable para ducha de mano.
- Ducha de mano anticalcárea de latón.
- Flexo satinado.



GRIFOS TERMOSTÁTICOS EMPOTRADOS

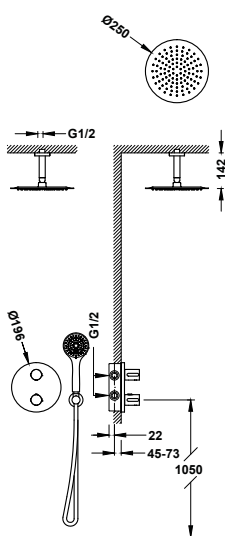

Kit de grifo termostático empotrado de 2 vías Therm-box para ducha

20425003

439,00

- Cuerpo empotrado incluido.
- Volante redondo de ABS con control de temperatura. Distribuidor cerámico de 2 vías.
- Brazo a techo con rociador de ducha orientable y de acero inoxidable: Ø 250 mm.
- Soporte para ducha de mano con toma de agua a pared.
- Ducha de mano anticalcárea: Ø 100 mm. (3 tipos de chorro).
- Flexo satinado.

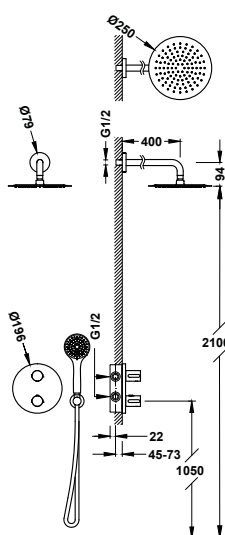

Kit de grifo termostático empotrado de 2 vías Therm-box para ducha

20425004

465,00

- Cuerpo empotrado incluido.
- Volante redondo de ABS con control de temperatura. Distribuidor cerámico de 2 vías.
- Brazo a pared con rociador de ducha orientable y de acero inoxidable: Ø 250 mm.
- Soporte para ducha de mano con toma de agua a pared.
- Ducha de mano anticalcárea: Ø 100 mm. (3 tipos de chorro).
- Flexo satinado.

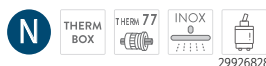

LLAVES DE PASO

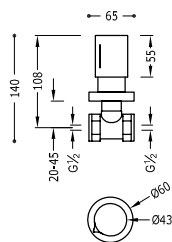

Llave de paso empotrada
Conexión a rosca hembra: 1/2".

06115501

80,00

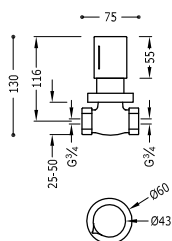

Llave de paso empotrada
Conexión a rosca hembra: 3/4".

06151101

88,00

CANIGÓ PLUS

El equilibrio entre el diseño y una buena experiencia en el baño no está reñido con la sostenibilidad. Canigó Plus incorpora en su grifería unas características que favorecen el ahorro de agua y energía ayudando a convertir cualquier baño en un espacio sostenible.

Acabados disponibles:



CR







GRIFOS PARA LAVABO

Grifo monomando para lavabo 21810303 **80,00**
 Latiguillos de alimentación flexibles G3/8.

29903504 IA DVGW

Grifo monomando para lavabo con Tres-Duo 21810301 **82,00**
 Latiguillos de alimentación flexibles G3/8.

29903501

Grifo monomando ecoeficiente para lavabo 21810401 **88,00**
 Latiguillos de alimentación flexibles G3/8.

29903505 IA

Grifo monomando alto para lavabo 21820303 **142,00**
 Latiguillos de alimentación flexibles G3/8.

29903504 DVGW

Grifo monomando alto para lavabo con Tres-Duo 21820301 **144,00**
 Latiguillos de alimentación flexibles G3/8.

29903501

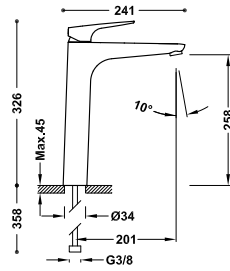

Grifo monomando XXL para lavabo
Latiguillos de alimentación flexibles G3/8.

21880301

175,00

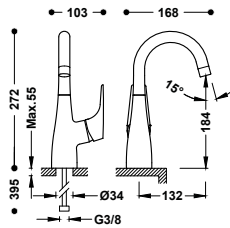
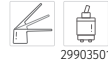

Grifo monomando con maneta lateral para lavabo
Latiguillos de alimentación flexibles G3/8.

21830802

130,00

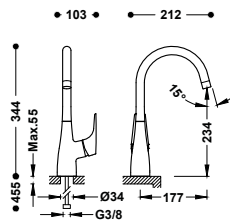

Grifo monomando alto con maneta lateral para lavabo
Latiguillos de alimentación flexibles G3/8.

21830801

140,00

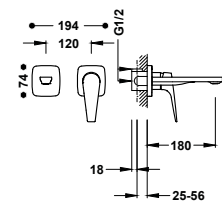

Grifo monomando empotrado para lavabo
Cuerpo empotrado indivisible con amortiguadores acústicos. Junta antihumedad. Caño de 180 mm.

21830003

190,00

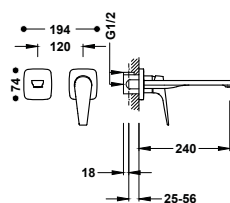

Grifo monomando empotrado para lavabo
Cuerpo empotrado indivisible con amortiguadores acústicos. Junta antihumedad. Caño de 240 mm.

21830004

200,00



GRIFOS PARA BIDÉ

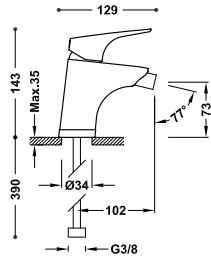

Grifo monomando para bidé
Latiguillos de alimentación flexibles G3/8.

21812001

83,00

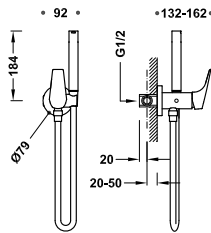

Grifo monomando empotrado con ducha para inodoro
Con agua fría o caliente. Ducha de mano con racor limitador a 5 l/min. y sistema antigoteo. Soporte fijo para la ducha de mano instalable a derecha o izquierda. Flexo satinado.

21712301

170,00



GRIFOS MURALES

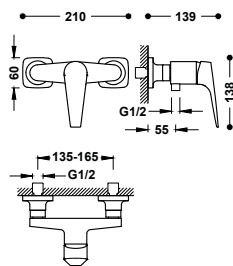

Grifo monomando mural para ducha
Sin complementos.

21826701

95,00

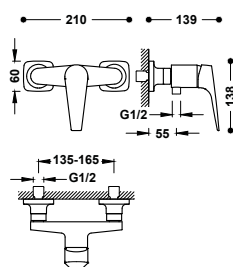

Grifo monomando mural para ducha
Ducha de mano anticalcárea 120x120 mm. (3 tipos de chorro). Soporte orientable para ducha de mano. Flexo metálico.

21816701

115,00



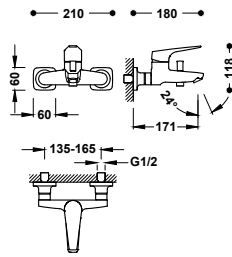

Grifo monomando mural para bañera y ducha
Sin complementos.

21827001

115,00

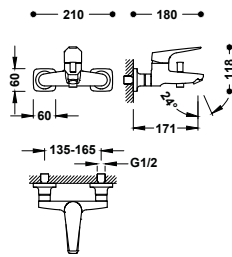

Grifo monomando mural para bañera y ducha

Ducha de mano anticalcárea 120x120 mm. (3 tipos de chorro). Soporte orientable para ducha de mano. Flexo metálico.

21817001

135,00

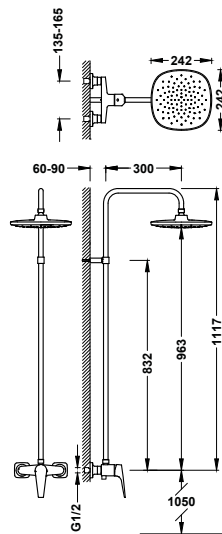
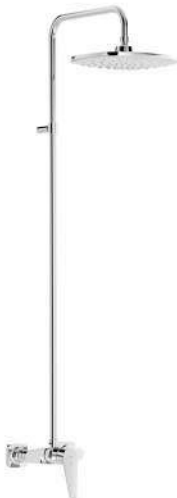

Conjunto de grifo monomando mural de 1 vía para ducha

· Rociador de ducha orientable: 242x242 mm.

21899501

268,00



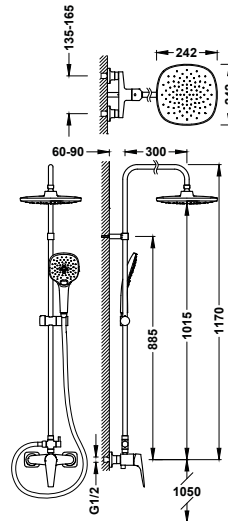

Conjunto de grifo monomando mural de 2 vías para ducha

21819101

301,00

- Con inversor integrado en la barra de ducha.
- Rociador de ducha orientable: 242x242 mm.
- Soporte deslizable y orientable para ducha de mano.
- Ducha de mano anticalcárea 120x120 mm. (3 tipos de chorro).
- Flexo metálico.



29903504

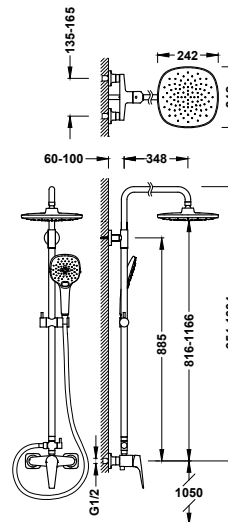

Conjunto de grifo monomando mural de 2 vías para ducha

21831221

431,00

- Con inversor integrado en la barra de ducha.
- Barra de ducha telescópica.
- Rociador de ducha orientable: 242x242 mm.
- Soporte deslizable y orientable para ducha de mano.
- Ducha de mano anticalcárea 120x120 mm. (3 tipos de chorro).
- Flexo metálico.



29903504



GRIFOS EMPOTRADOS RAPID-BOX

Pieza vista para caja empotrada de 1 vía Rapid-box

21827810

60,00

Sólo parte vista. Incluye placa embellecedora, mando, casquillo y tornillo de fijación oculto. **Caja empotrada no incluida.**

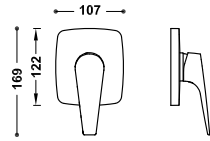

Caja empotrada de 1 vía Rapid-box con grifo monomando para ducha

20827810

80,00 **N**



Pieza vista para caja empotrada de 2 vías Rapid-box

21828110

75,00

Sólo parte vista. Incluye placa embellecedora, mando, volante distribuidor y tornillo de fijación oculto. **Caja empotrada no incluida.**

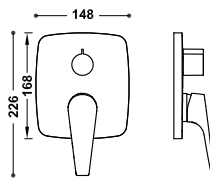

Caja empotrada de 2 vías Rapid-box con grifo monomando para ducha y bañera

20828110

90,00 **N**



Kit de grifo monomando empotrado de 2 vías Rapid-box para ducha

21828004

369,00

- Cuerpo empotrado incluido.
- Distribuidor cerámico de 2 vías.
- Brazo a pared con rociador de ducha orientable: 242x242 mm.
- Soporte para ducha de mano con toma de agua a pared.
- Ducha de mano anticalcárea 120x120 mm. (3 tipos de chorro).
- Flexo metálico.

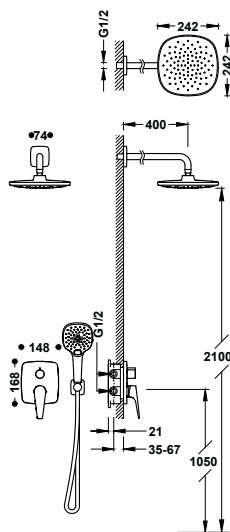

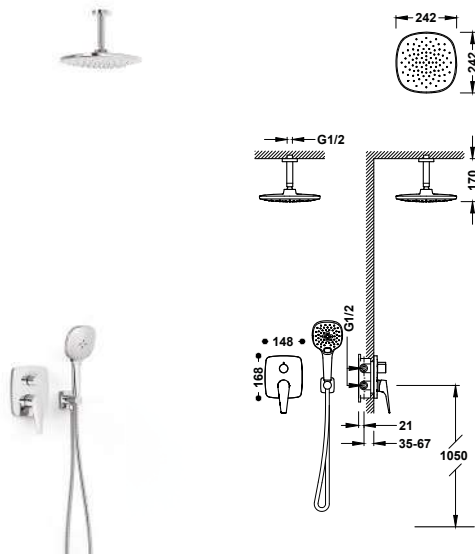

Kit de grifo monomando empotrado de 2 vías Rapid-box para ducha

21828003

341,00

- Cuerpo empotrado incluido.
- Distribuidor cerámico de 2 vías.
- Brazo a techo con rociador de ducha orientable: 242x242 mm.
- Soporte para ducha de mano con toma de agua a pared.
- Ducha de mano anticalcárea 120x120 mm. (3 tipos de chorro).
- Flexo metálico.



29903508

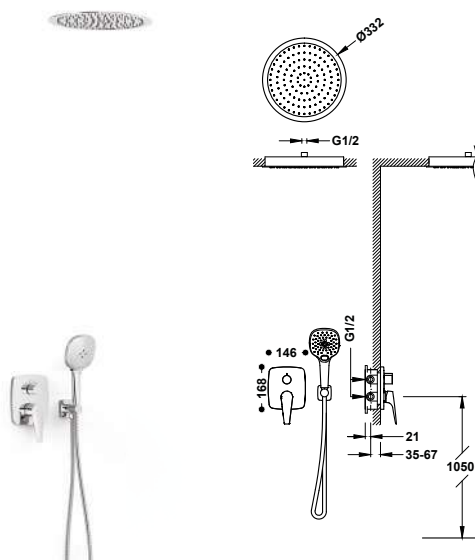

Kit de grifo monomando empotrado de 2 vías Rapid-box para ducha

21828005

589,00

- Cuerpo empotrado incluido.
- Distribuidor cerámico de 2 vías.
- Rociador empotrado a techo de latón: Ø 332 mm.
- Soporte para ducha de mano con toma de agua a pared.
- Ducha de mano anticalcárea 120x120 mm. (3 tipos de chorro).
- Flexo metálico.



29903508

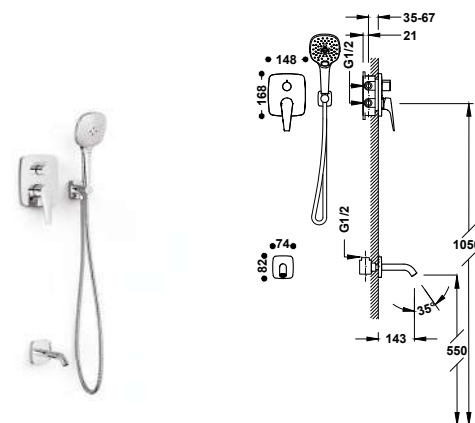

Kit de grifo monomando empotrado de 2 vías Rapid-box para bañera y ducha

21828006

340,00

- Cuerpo empotrado incluido.
- Distribuidor cerámico de 2 vías.
- Caño fijo de bañera a pared.
- Soporte para ducha de mano con toma de agua a pared.
- Ducha de mano anticalcárea 120x120 mm. (3 tipos de chorro).
- Flexo metálico.



29903508



GRIFOS TERMOSTÁTICOS MURALES

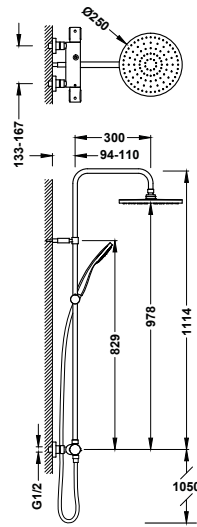

Conjunto de grifo termostático mural Over-wall de 2 vías para ducha

19039301

411,00

- Con inversor integrado en el regulador de caudal.
- Volante redondo de ABS.
- Rociador de ducha orientable: Ø 250 mm.
- Soporte deslizante y orientable para ducha de mano.
- Ducha de mano anticalcárea: Ø 100 mm.
- Flexo metálico.

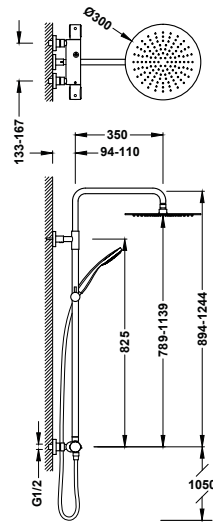

Conjunto de grifo termostático mural Over-wall de 2 vías para ducha

19038701

483,00

- Con inversor integrado en el regulador de caudal.
- Volante redondo de ABS.
- Barra de ducha telescópica.
- Rociador de ducha orientable de acero inoxidable: Ø 300 mm.
- Soporte deslizante y orientable para ducha de mano.
- Ducha de mano anticalcárea.
- Flexo metálico.



GRIFOS TERMOSTÁTICOS EMPOTRADOS

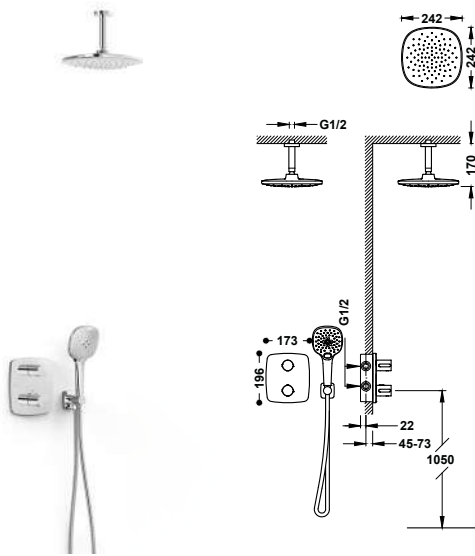

Kit de grifo termostático empotrado de 2 vías Therm-box para ducha

21725003

391,00

- Cuerpo empotrado incluido.
- Volante redondo de ABS con control de temperatura. Distribuidor cerámico de 2 vías.
- Brazo a techo con rociador de ducha orientable: 242x242 mm.
- Soporte para ducha de mano con toma de agua a pared.
- Ducha de mano anticalcárea 120x120 mm. (3 tipos de chorro).
- Flexo metálico.

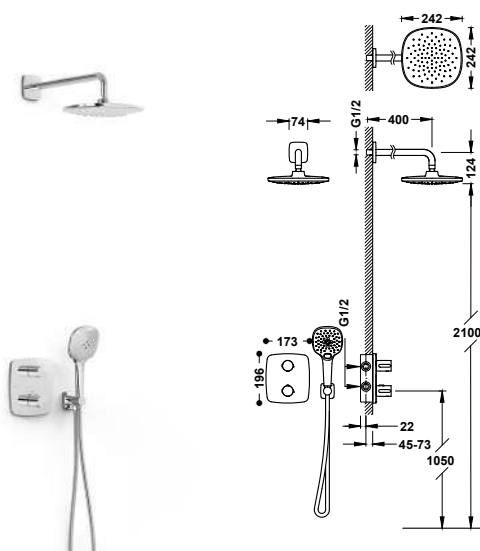

Kit de grifo termostático empotrado de 2 vías Therm-box para ducha

21725004

419,00

- Cuerpo empotrado incluido.
- Volante redondo de ABS con control de temperatura. Distribuidor cerámico de 2 vías.
- Brazo a pared con rociador de ducha orientable: 242x242 mm.
- Soporte para ducha de mano con toma de agua a pared.
- Ducha de mano anticalcárea 120x120 mm. (3 tipos de chorro).
- Flexo metálico.



CANIGÓ

Tres ha otorgado a la serie Canigó unas características que fomentan el ahorro de agua y de energía. La trayectoria inclinada de la maneta y la robustez de los cuerpos se integra con los ángulos redondeados de sus contornos, dotando de personalidad y diferenciación a toda la serie.

Acabados disponibles:



CR







GRIFOS PARA LAVABO

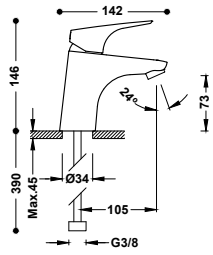

Grifo monomando para lavabo
Latiguillos de alimentación flexibles G3/8.

21710303 **75,00**

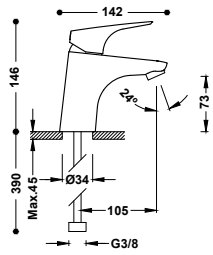

Grifo monomando para lavabo con Tres-Duo
Latiguillos de alimentación flexibles G3/8.

21710301 **77,00**

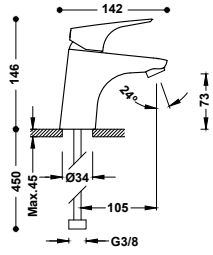

Grifo monomando ecoeficiente para lavabo
Latiguillos de alimentación flexibles G3/8.

21710401 **83,00**

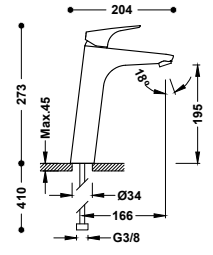

Grifo monomando alto para lavabo
Latiguillos de alimentación flexibles G3/8.

21720303 **139,00**

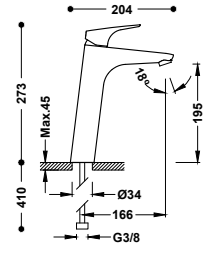

Grifo monomando alto para lavabo con Tres-Duo
Latiguillos de alimentación flexibles G3/8.

21720301 **141,00**



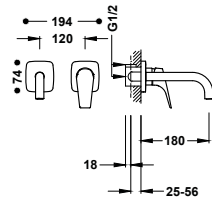

Grifo monomando empotrado para lavabo

Cuerpo empotrado indivisible con amortiguadores acústicos. Junta antihumedad. Caño de 180 mm.

21730001

180,00

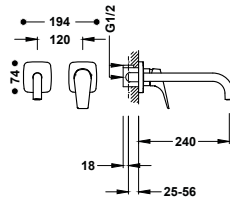

Grifo monomando empotrado para lavabo

Cuerpo empotrado indivisible con amortiguadores acústicos. Junta antihumedad. Caño de 240 mm.

21730002

190,00



GRIFOS PARA BIDÉ

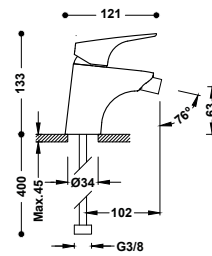

Grifo monomando para bidé

Latiguillos de alimentación flexibles G3/8.

21712001

78,00

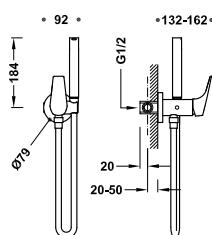

Grifo monomando empotrado con ducha para inodoro

Con agua fría o caliente. Ducha de mano con racor limitador a 5 l/min. y sistema antigoteo. Soporte fijo para la ducha de mano instalable a derecha o izquierda. Flexo satinado.

21712301

170,00



GRIFOS MURALES

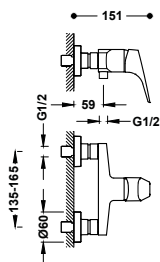

Grifo monomando mural para ducha
Sin complementos.

21726701

80,00

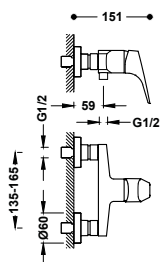

Grifo monomando mural para ducha

Ducha de mano anticalcárea 120x120 mm. (3 tipos de chorro). Soporte orientable para ducha de mano. Flexo metálico.

21716701

100,00

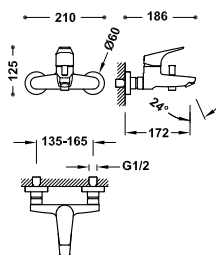

Grifo monomando mural para bañera y ducha

Sin complementos.

21727001

100,00

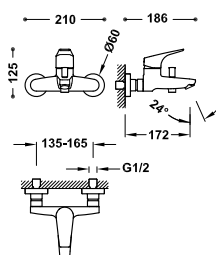

Grifo monomando mural para bañera y ducha

Ducha de mano anticalcárea 120x120 mm. (3 tipos de chorro). Soporte orientable para ducha de mano. Flexo metálico.

21717001

120,00



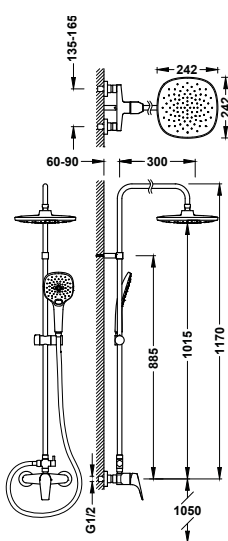

Conjunto de grifo monomando mural de 2 vías para ducha

21719101

293,00

- Con inversor integrado en la barra de ducha.
- Rociador de ducha orientable: 242x242 mm.
- Soporte deslizante y orientable para ducha de mano.
- Ducha de mano anticalcárea 120x120 mm. (3 tipos de chorro).
- Flexo metálico.



29903504

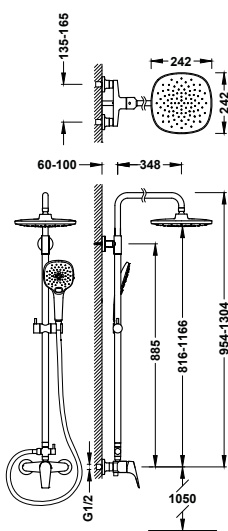

Conjunto de grifo monomando mural de 2 vías para ducha

21731221

445,00

- Con inversor integrado en la barra de ducha.
- Barra de ducha telescópica.
- Rociador de ducha orientable: 242x242 mm.
- Soporte deslizante y orientable para ducha de mano.
- Ducha de mano anticalcárea 120x120 mm. (3 tipos de chorro).
- Flexo metálico.



29903504

GRIFOS EMPOTRADOS RAPID-BOX

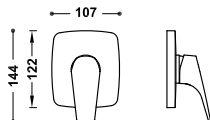

Pieza vista para caja empotrada de 1 vía Rapid-box

21727810

60,00

Sólo parte vista. Incluye placa embellecedora, mando, casquillo y tornillo de fijación oculto. **Caja empotrada no incluida.**



RAPID BOX



Caja empotrada de 1 vía Rapid-box con grifo monomando para ducha

20827810

80,00

Pieza vista para caja empotrada de 2 vías Rapid-box

21728110

75,00

Sólo parte vista. Incluye placa embellecedora, mando, volante distribuidor y tornillo de fijación oculto. Caja empotrada no incluida.

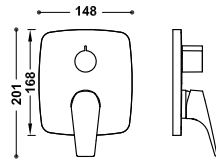

Caja empotrada de 2 vías Rapid-box con grifo monomando para ducha y bañera

20828110

90,00 **N**

Kit de grifo monomando empotrado de 2 vías Rapid-box para ducha

21728004

368,00

- Cuerpo empotrado incluido.
- Distribuidor cerámico de 2 vías.
- Brazo a pared con rociador de ducha orientable: 242x242 mm.
- Soporte para ducha de mano con toma de agua a pared.
- Ducha de mano anticalcárea 120x120 mm. (3 tipos de chorro).
- Flexo metálico.

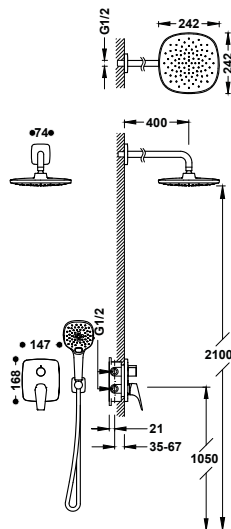

Kit de grifo monomando empotrado de 2 vías Rapid-box para ducha

21728003

341,00

- Cuerpo empotrado incluido.
- Distribuidor cerámico de 2 vías.
- Brazo a techo con rociador de ducha orientable: 242x242 mm.
- Soporte para ducha de mano con toma de agua a pared.
- Ducha de mano anticalcárea 120x120 mm. (3 tipos de chorro).
- Flexo metálico.

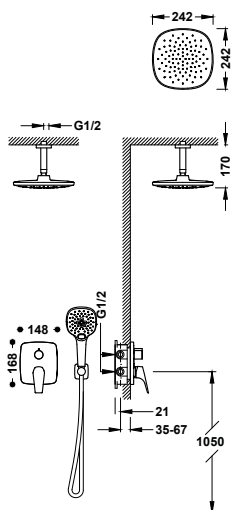

GRIFOS EMPOTRADOS

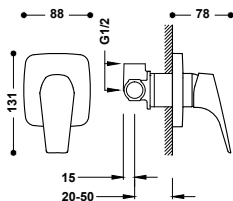

Grifo monomando empotrado de 1 vía para ducha
Cuerpo empotrado incluido.

21717701

92,00

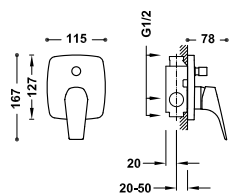

Grifo monomando empotrado de 2 vías para bañera y ducha
Cuerpo empotrado incluido. Inversor de 2 vías.

21718001

132,00



GRIFOS TERMOSTÁTICOS MURALES

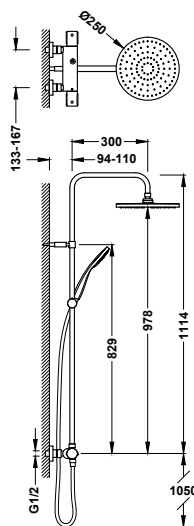

Conjunto de grifo termostático mural Over-wall de 2 vías para ducha

19039301

411,00

- Con inversor integrado en el regulador de caudal.
- Volante redondo de ABS.
- Rociador de ducha orientable: Ø 250 mm.
- Soporte deslizante y orientable para ducha de mano.
- Ducha de mano anticalcárea: Ø 100 mm.
- Flexo metálico.



OVER WALL



29916831XX

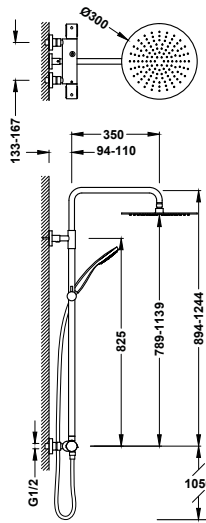

Conjunto de grifo termostático mural Over-wall de 2 vías para ducha

19038701

483,00

- Con inversor integrado en el regulador de caudal.
- Volante redondo de ABS.
- Barra de ducha telescópica.
- Rociador de ducha orientable de acero inoxidable: Ø 300 mm.
- Soporte deslizante y orientable para ducha de mano.
- Ducha de mano anticalcárea.
- Flexo metálico.



GRIFOS TERMOSTÁTICOS EMPOTRADOS

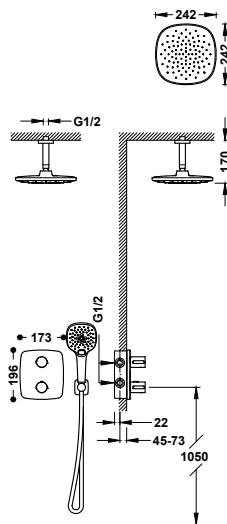

Kit de grifo termostático empotrado de 2 vías Therm-box para ducha

21725003

391,00

- Cuerpo empotrado incluido.
- Volante redondo de ABS con control de temperatura. Distribuidor cerámico de 2 vías.
- Brazo a techo con rociador de ducha orientable: 242x242 mm.
- Soporte para ducha de mano con toma de agua a pared.
- Ducha de mano anticalcárea 120x120 mm. (3 tipos de chorro).
- Flexo metálico.



Kit de grifo termostático empotrado de 2 vías Therm-box para ducha

21725004

419,00

- Cuerpo empotrado incluido.
- Volante redondo de ABS con control de temperatura. Distribuidor cerámico de 2 vías.
- Brazo a pared con rociador de ducha orientable: 242x242 mm.
- Soporte para ducha de mano con toma de agua a pared.
- Ducha de mano anticalcárea 120x120 mm. (3 tipos de chorro).
- Flexo metálico.

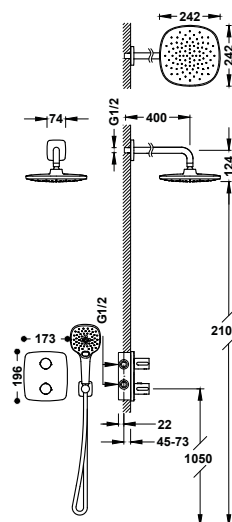

BASE PLUS

La serie Base Plus se caracteriza por sus líneas simples y adaptables a cualquier ambiente. Su aspecto minimalista, así como un mando ergonómico y un cuerpo con líneas sinuosas, agradables y claras, permite equipar el baño con los elementos esenciales.

Acabados disponibles:



CR



NM







GRIFOS PARA LAVABO

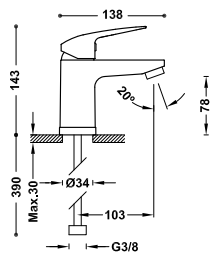

Grifo monomando para lavabo
Latiguillos de alimentación flexibles G3/8.

■ 21610303 **58,00**

■ 21610303NM **89,90**

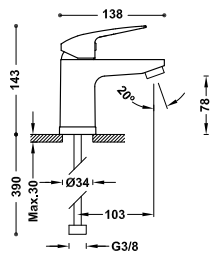

Grifo monomando para lavabo con Tres-Duo
Latiguillos de alimentación flexibles G3/8.

■ 21610310 **60,00**

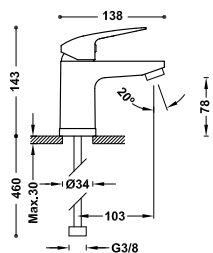

Grifo monomando ecoeficiente para lavabo
Latiguillos de alimentación flexibles G3/8.

■ 21610410 **66,00**



GRIFOS PARA BIDÉ

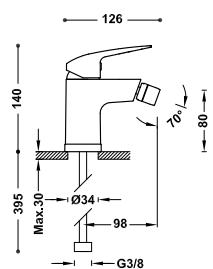

Grifo monomando para bidé
Latiguillos de alimentación flexibles G3/8.

■ 21612010 **61,00**

■ 21612010NM **94,55**



GRIFOS MURALES

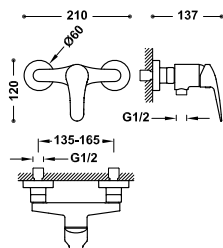

Grifo monomando mural para ducha
Sin complementos.

21626710

75,00

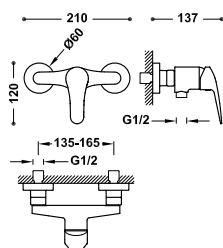

Grifo monomando mural para ducha

Ducha de mano anticalcárea. Soporte orientable para ducha de mano. Flexo metálico.

21616710

89,00

21616710NM

138,00

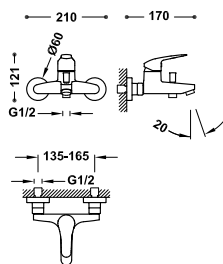

Grifo monomando mural para bañera y ducha

Sin complementos.

21627010

95,00

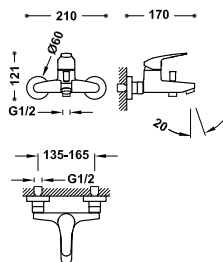

Grifo monomando mural para bañera y ducha

Ducha de mano anticalcárea. Soporte orientable para ducha de mano. Flexo metálico.

21617010

109,00

21617010NM

169,00



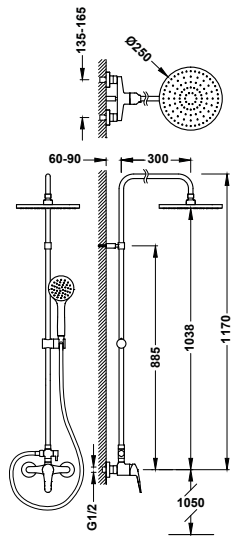

Conjunto de grifo monomando mural de 2 vías para ducha

21619110

309,00

- Con inversor integrado en la barra de ducha.
- Rociador de ducha orientable: Ø 250 mm.
- Soporte deslizante y orientable para ducha de mano.
- Ducha de mano anticalcárea.
- Flexo metálico.

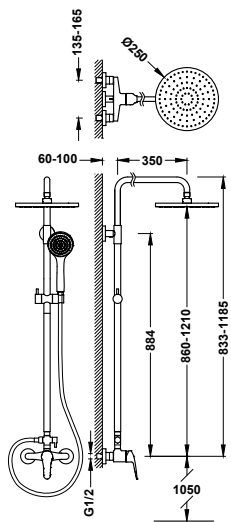

Conjunto de grifo monomando mural de 2 vías para ducha

21631221

439,00

- Con inversor integrado en la barra de ducha.
- Rociador de ducha orientable: Ø 250 mm.
- Barra de ducha telescópica.
- Soporte deslizante y orientable para ducha de mano.
- Ducha de mano anticalcárea.
- Flexo metálico.



GRIFOS EMPOTRADOS RAPID-BOX

Pieza vista para caja empotrada de 1 vía Rapid-box

21627810

55,00

Sólo parte vista. Incluye placa embellecedora, mando, casquillo y tornillo de fijación oculto. Caja empotrada no incluida.

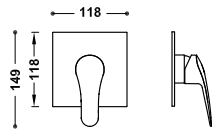

Caja empotrada de 1 vía Rapid-box con grifo monomando para ducha

20827810

80,00

Pieza vista para caja empotrada de 2 vías Rapid-box

21628110

70,00

Sólo parte vista. Incluye placa embellecedora, mando, volante distribuidor y tornillo de fijación oculto. Caja empotrada no incluida.

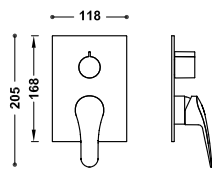

Caja empotrada de 2 vías Rapid-box con grifo monomando para ducha y bañera

20828110

90,00

Kit de grifo monomando empotrado de 2 vías Rapid-box para ducha

21628004

334,00

- Cuerpo empotrado incluido.
- Distribuidor cerámico de 2 vías.
- Brazo a pared con rociador de ducha orientable y de acero inoxidable: Ø 250 mm.
- Soporte para ducha de mano con toma de agua a pared.
- Ducha de mano anticalcárea: Ø 100 mm.
- Flexo metálico.

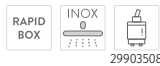
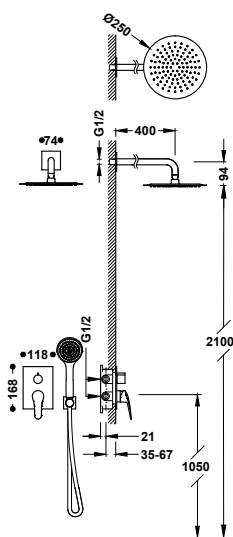

GRIFOS EMPOTRADOS

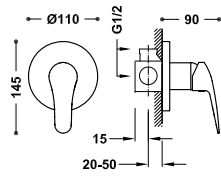

Grifo monomando empotrado de 1 vía para ducha
Cuerpo empotrado incluido.

21617701

87,00

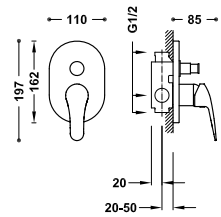

Grifo monomando empotrado de 2 vías para bañera y ducha
Cuerpo empotrado incluido. Inversor de 2 vías.

21618001

122,00

GRIFOS TERMOSTÁTICOS MURALES

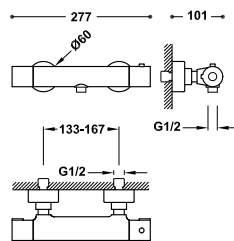

Grifo termostático mural para ducha
Sin complementos.

21616401

135,00

21616401NM

209,00 N

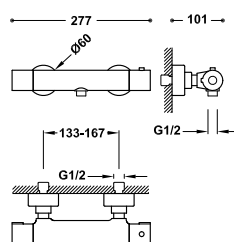

Grifo termostático mural para ducha

Ducha de mano anticalcárea: Ø 100 mm. Soporte orientable para ducha de mano. Flexo metálico.

21616409

149,00

21616409NM

231,00 N

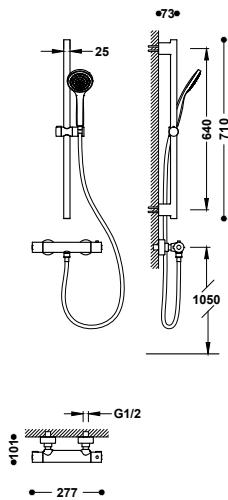

Kit de grifo termostático mural para ducha

- Barra de ducha: long. 640 mm.
- Soporte deslizante y orientable para ducha de mano.
- Ducha de mano anticalcárea: Ø 100 mm.
- Flexo metálico.

21619601 **244,00**

21619601NM **378,00**

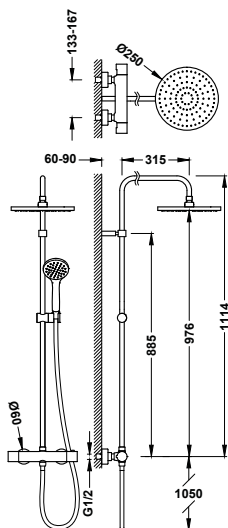

Conjunto de grifo termostático mural de 2 vías para ducha

- Con inversor integrado en el regulador de caudal.
- Rociador de ducha orientable: Ø 250 mm.
- Soporte deslizante y orientable para ducha de mano.
- Ducha de mano anticalcárea: Ø 100 mm.
- Flexo metálico.

21639301 **336,00**

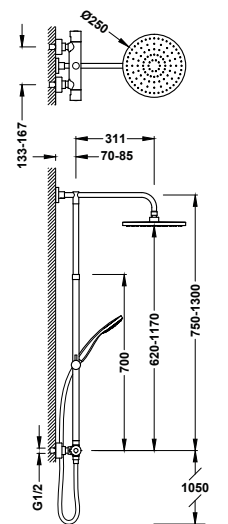

Conjunto de grifo termostático mural de 2 vías para ducha

- Con inversor integrado en el regulador de caudal.
- Barra de ducha de longitud variable hasta su fijación.
- Rociador de ducha orientable: Ø 250 mm.
- Soporte deslizante y orientable para ducha de mano.
- Ducha de mano anticalcárea: Ø 100 mm.
- Flexo satinado.

21639302NM **520,00**



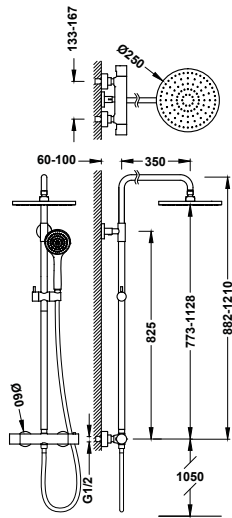

Conjunto de grifo termostático mural de 2 vías para ducha

21639521

436,00

- Con inversor integrado en el regulador de caudal.
- Barra de ducha telescópica.
- Rociador de ducha orientable: Ø 250 mm.
- Soporte deslizante y orientable para ducha de mano.
- Ducha de mano anticalcárea: Ø 100 mm.
- Flexo metálico.

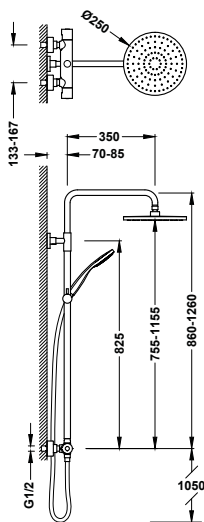

Conjunto de grifo termostático mural de 2 vías para ducha

21639502NM

651,00

- Con inversor integrado en el regulador de caudal.
- Barra de ducha telescópica.
- Rociador de ducha orientable: Ø 250 mm.
- Soporte deslizante y orientable para ducha de mano.
- Ducha de mano anticalcárea: Ø 100 mm.
- Flexo satinado.



GRIFOS TERMOSTÁTICOS EMPOTRADOS

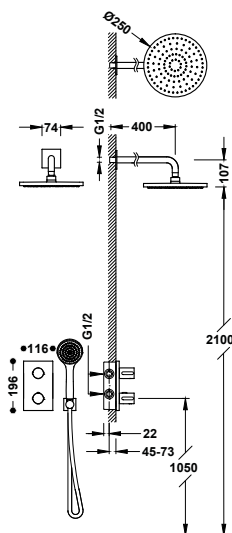

Kit de grifo termostático empotrado de 2 vías Therm-box para ducha

21625004

405,00

- Cuerpo empotrado incluido.
- Volante redondo de ABS con control de temperatura. Distribuidor cerámico de 2 vías.
- Brazo a pared con rociador de ducha orientable: Ø 250 mm.
- Soporte para ducha de mano con toma de agua a pared.
- Ducha de mano anticalcárea.
- Flexo metálico.



BASE

Con la serie Base se puede equipar el baño con lo esencial ya que cada grifo de esta serie cumple una función y ha sido diseñado para combinar la eficiencia y seguridad con la simpleza de su funcionalidad. Base es básicamente simple. Básicamente única.

Acabados disponibles:



CR







GRIFOS PARA LAVABO

Grifo monomando para lavabo 21510303 **51,00**
 Latiguillos de alimentación flexibles G3/8.

Grifo monomando para lavabo con válvula desagüe Click-Clack 21510303D **61,00**
 Latiguillos de alimentación flexibles G3/8.

Grifo monomando para lavabo con Tres-Duo 21510310 **54,00**
 Latiguillos de alimentación flexibles G3/8.

Grifo monomando para lavabo con Tres-Duo y válvula desagüe Click-Clack 21510310D **64,00**
 Latiguillos de alimentación flexibles G3/8.

Grifo monomando ecoeficiente para lavabo 21510410 **60,00**
 Latiguillos de alimentación flexibles G3/8.



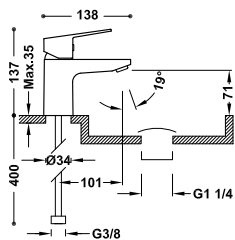

Grifo monomando ecoeficiente para lavabo con válvula desagüe Click-Clack

Latiguillos de alimentación flexibles G3/8.

21510410D

70,00



29903505

GRIFOS PARA BIDÉ

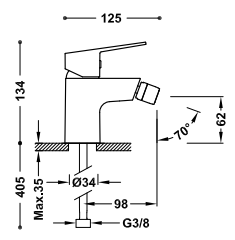

Grifo monomando para bidé

Latiguillos de alimentación flexibles G3/8.

21512010

54,00



29903504

IA

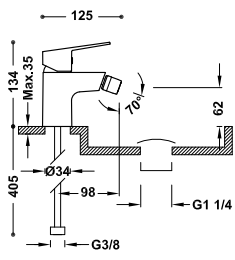

Grifo monomando para bidé con válvula desagüe Click-Clack

Latiguillos de alimentación flexibles G3/8.

21512010D

64,00



29903504

GRIFOS MURALES

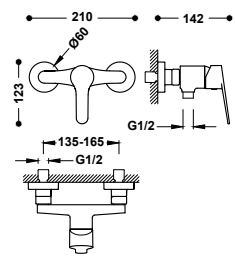

Grifo monomando mural para ducha

Sin complementos.

21526710

70,00



29903504

IA

IA

DVGW

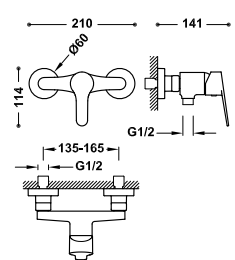

Grifo monomando mural para ducha

Ducha de mano anticálcarea. Soporte articulado para ducha de mano. Flexo metálico.

21516710

84,00



29903504



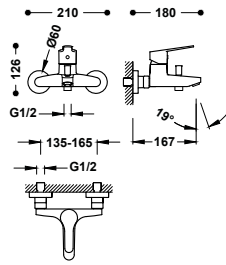

Grifo monomando mural para bañera y ducha
Sin complementos.

21527010

85,00

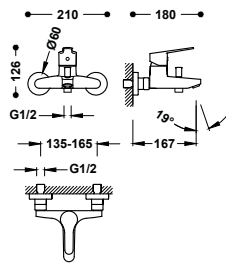

Grifo monomando mural para bañera y ducha
Ducha de mano anticalcárea. Soporte articulado para ducha de mano. Flexo metálico.

21517010

99,00



GRIFOS EMPOTRADOS RAPID-BOX

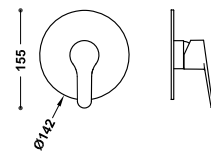

Pieza vista para caja empotrada de 1 vía Rapid-box

Sólo parte vista. Incluye placa embellecedora, mando, casquillo y tornillo de fijación oculto. Caja empotrada no incluida.

21527810

55,00



Caja empotrada de 1 vía Rapid-box con grifo monomando para ducha

20827810

80,00 **N**

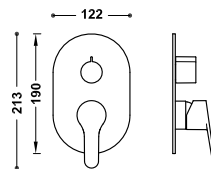

Pieza vista para caja empotrada de 2 vías Rapid-box

Sólo parte vista. Incluye placa embellecedora, mando, volante distribuidor y tornillo de fijación oculto. Caja empotrada no incluida.

21528110

70,00



Caja empotrada de 2 vías Rapid-box con grifo monomando para ducha y bañera

20828110

90,00 **N**



GRIFOS EMPOTRADOS

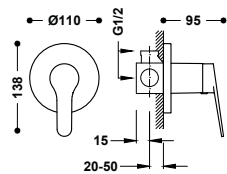

Grifo monomando empotrado de 1 vía para ducha
Cuerpo empotrado incluido.

21517701

80,00



9134592

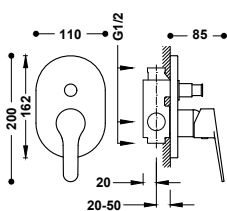

Grifo monomando empotrado de 2 vías para bañera y ducha
Cuerpo empotrado incluido. Inversor de 2 vías.

21518001

115,00



9134592

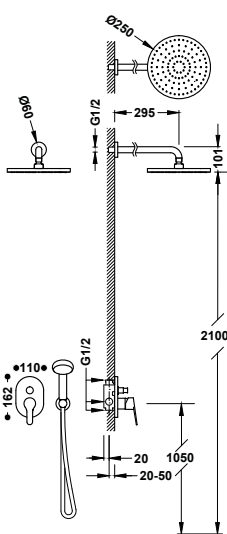

Kit de grifo monomando empotrado de 2 vías para ducha

21599002

241,00

- Cuerpo empotrado incluido.
- Inversor de 2 vías.
- Brazo a pared con rociador de ducha orientable: Ø 250 mm.
- Soporte para ducha de mano con toma de agua a pared.
- Ducha de mano anticalcárea.
- Flexo metálico.



9134592

GRIFOS PARA VARIOS USOS

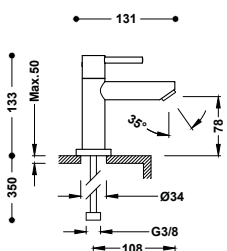

Grifo de 1 agua para lavabo
Con latiguillo de alimentación flexible G3/8.

06250301

62,00

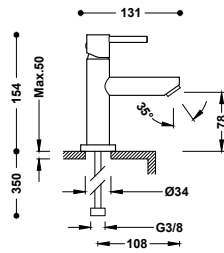

Grifo monomando para lavabo
Latiguillos de alimentación flexibles G3/8.

06260301

60,00

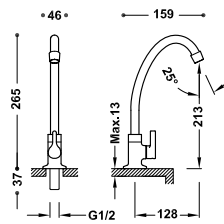

Grifo de 1 agua con maneta lateral para office o lavadero
Con conexión roscada macho de G1/2.

21530601

26,00

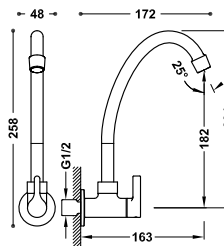

Grifo mural de 1 agua para office o lavadero
Con conexión roscada macho de G1/2.

21550601

30,00

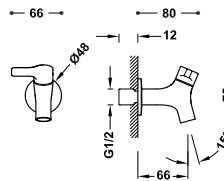

Grifo mural de 1 agua para office o lavadero
Con conexión roscada macho de G1/2. Caño de 66 mm.

21552001

24,00

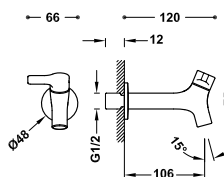

Grifo mural de 1 agua para office o lavadero
Con conexión roscada macho de G1/2. Caño de 106 mm.

21552002

25,50

ESE-23

La serie bimando Ese-23 es la alternativa asequible para la grifería básica. Los volantes retro con indicadores de agua caliente o fría y sus cuerpos condensados caracterizan una serie con las piezas principales para una vivienda.

Acabados disponibles:



CR



TRES



GRIFOS PARA LAVABO

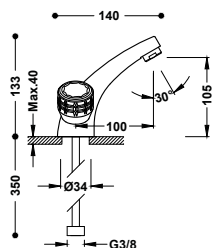

Grifo bimando para lavabo
Latiguillos de alimentación flexibles G3/8.

123103

105,00



9134284

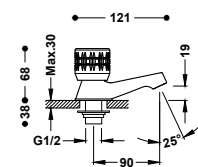

Grifo de 1 agua para lavabo
Conexión roscada macho de G1/2. Con índice azul.

123100F
123100C

35,00

35,00



9134284

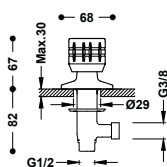

Grifo lateral sin caño para lavabo

123510F
123510C

57,00

57,00



9134285

GRIFOS PARA BIDÉ

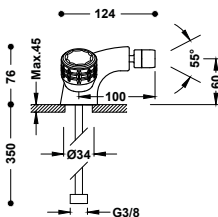

Grifo bimando para bidé
Latiguillos de alimentación flexibles G3/8.

123120

108,00



9134284

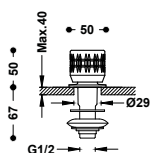

Grifo lateral sin caño para bidé
Conexión roscada macho de G1/2.

123125F
123125C

39,00

39,00



9134284

GRIFOS MURALES

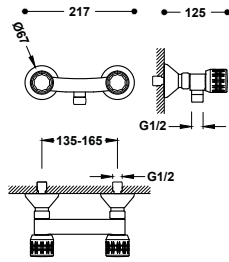

Grifo bimando mural para ducha

Ducha de mano anticalcárea. Soporte orientable para ducha de mano. Flexo metálico reforzado.

123167

115,00

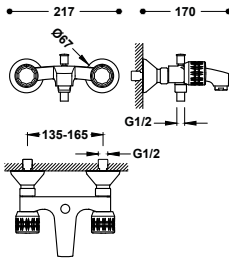

Grifo bimando mural para bañera y ducha

Ducha de mano anticalcárea. Soporte orientable para ducha de mano. Flexo metálico reforzado.

123170

155,00



GRIFOS PARA VARIOS USOS

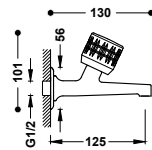

Grifo mural de 1 agua para office o lavadero

Conexión roscada macho de G1/2.

123520F
123520C

35,00
35,00

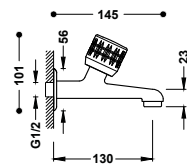

Grifo mural de 1 agua para office o lavadero

Conexión roscada macho de G1/2.

02352001F
02352001C

42,00
42,00

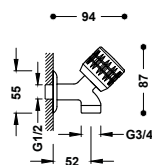

Grifo mural de 1 agua para lavadora

Conexión roscada macho de G1/2.

123500F
123500C

24,00
24,00



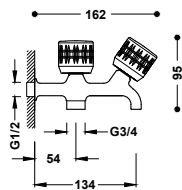

Grifo mural doble de 1 agua para lavadora

Salida 1: Conexión roscada macho: 3/4". Salida 2: a lavadero.

123515

42,00

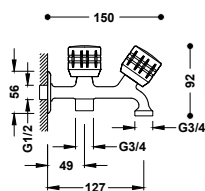

Grifo mural doble de 1 agua para lavadora

Salida 1 y 2: Conexión roscada macho: 3/4".

02351501

45,00



LLAVES DE PASO

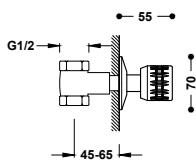

Llave de paso empotrada 1/2"

Conexión roscada hembra: 1/2".

123155F
123155C

32,00

32,00

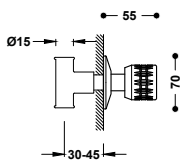

Llave de paso empotrada Ø 15 mm

Conexión soldada hembra: Ø 15 mm.

123511F
123511C

30,00

30,00

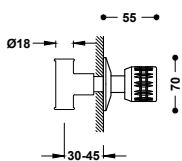

Llave de paso empotrada Ø 18 mm

Conexión soldada hembra: Ø 18 mm.

123512F
123512C

29,00

29,00



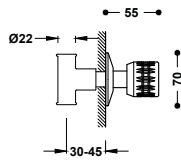

Llave de paso empotrada Ø 22 mm
Conexión soldada hembra: Ø 22 mm.

- ❄️ 123513F **28,00**
- ☀️ 123513C **28,00**

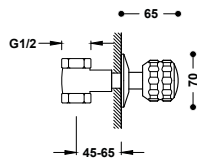

Llave de paso empotrada 1/2"
Conexión roscada hembra: 1/2".

- ❄️ 13315510F **60,00**
- ☀️ 13315510C **60,00**

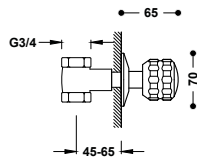

Llave de paso empotrada 3/4"
Conexión roscada hembra: 3/4".

- ❄️ 13315710F **72,00**
- ☀️ 13315710C **72,00**

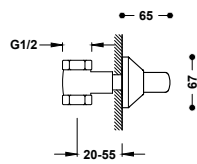

Llave de paso empotrada con regulación oculta 1/2"
Conexión roscada hembra: 1/2".

- 133516 **54,00**

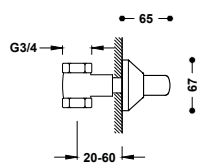

Llave de paso empotrada con regulación oculta 3/4"
Conexión roscada hembra: 3/4".

- 133517 **56,00**



ESPACIO DE DUCHA





ELECTRÓNICOS

Shower Technology 228

TERMOSTÁTICOS

Empotrados B-system 242

Empotrados Therm-box 252

Murales Over-wall 272

MONOMANDOS

Empotrados 3V 290

Empotrados Rapid-box 298

Empotrados 322

Murales 336

Borde de bañera 346

SHOWER TECHNOLOGY

Equipar la ducha o bañera con Shower technology da mucha más satisfacción. Tres ha mejorado su innovación electrónica para tener un control absoluto de la ducha. La ducha está al servicio del usuario ya que integra nuevas capacidades para aumentar su seguridad, el ahorro de agua y la comodidad para ducharse cuando todo esté listo.

Acabados disponibles:



CR



NM



OM



OPM





Shower technology

La ducha electrónica al siguiente nivel

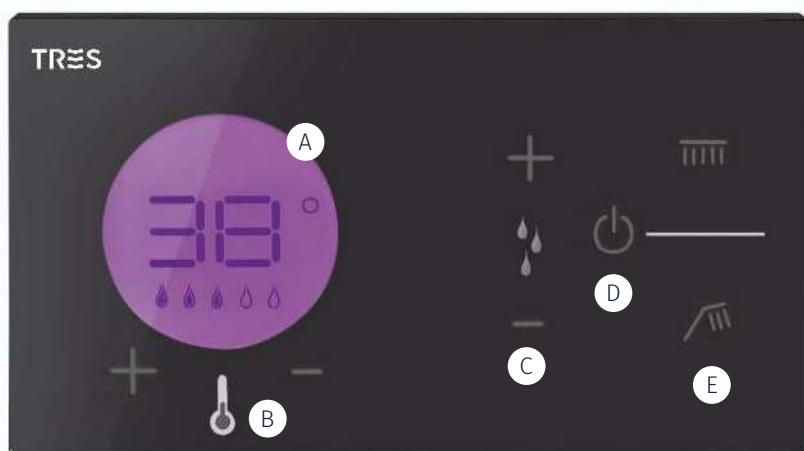

- Ⓐ Pantalla de información
- Ⓑ Selector de temperatura
- Ⓒ Control de caudal
- Ⓓ Encendido, apagado y pausa
- Ⓔ Control de salida del agua

De 2 a 4 salidas de agua distintas

El control digital está adaptado para cada conjunto de ducha, según la cantidad de vías de salida de agua que se deseen. De esa forma, con solo tocar la pantalla, se activa la salida deseada, sea el rociador, la ducha, los jets o la cascada. Las versiones de 3 y 4 salidas permiten utilizar dos salidas de agua a la vez en un único uso.



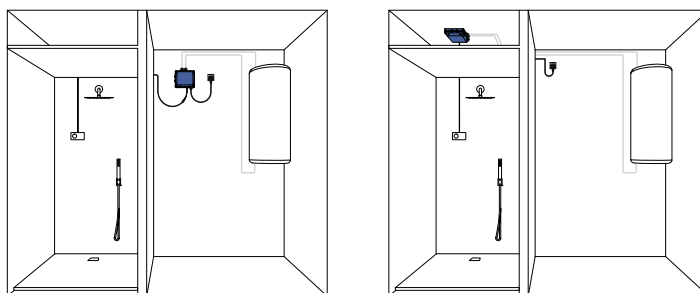
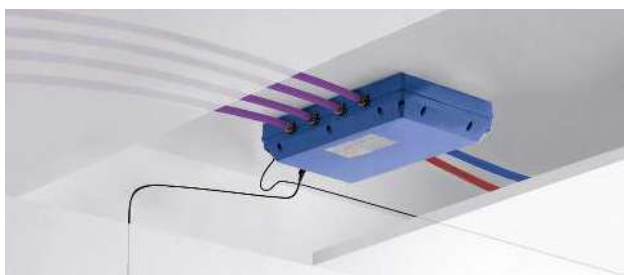

Instalación en el mínimo espacio

La centralita termostática electrónica se puede instalar hasta un máximo de 10 metros de distancia de la pantalla de control.

Tiene las mejores juntas antihumedad

Sistema empotrado totalmente estanco y antihumedades con juntas Schlüter.

Pantalla hermética

La pantalla de control es totalmente hermética, con iluminación en los botones en funcionamiento y con acabado en blanco o en negro.

Temperatura precisa

La temperatura se encuentra en 38°C cuando se abre inicialmente. Su límite es 46°C como máximo. El nivel de temperatura seleccionada se indica numéricamente y en escala de colores.

Prepara tu ducha para que esté perfecta cuando entres

El grifo se parará cuando llegue a la temperatura programada y la ducha estará preparada para que entres cuando quieras.

Permite la desinfección de la legionela

Incluye un programa para prevenir la legionela (5 minutos a 60°C) o directamente para desinfectar (10 minutos a 60°C).



COMPLETA TU DUCHA ELECTRÓNICA



+

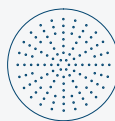

2 vías (492 862 99 - 492 882 99)

3 vías (492 863 98 - 492 883 98)

3 vías (492 863 99 - 492 883 99)

4 vías (492 864 99 - 492 884 99)

Se recomienda la instalación de complementos de ducha de Tres para garantizar su buen funcionamiento.

PANTALLA DE CONTROL

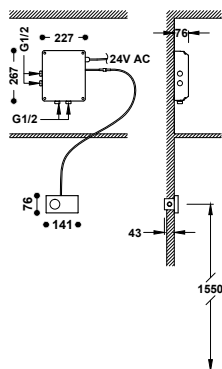

Control termostático electrónico empotrado de 2 vías Shower Technology Blue Edition

49286299

990,00

49288299

990,00

- Control electrónico incluido con juntas antihumedad Schlüter.
- Centralita termostática electrónica incluida (2 vías).
- Temperatura mínima disponible inferior a los 25°C.
- Sistema puesta a punto: Preparación de la temperatura deseada.
- Con programas antilegionela.

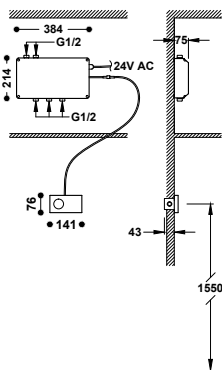

Control termostático electrónico empotrado de 3 vías Shower Technology Blue Edition

49286398

1.060,00

49288398

1.060,00

- Control electrónico incluido con juntas antihumedad Schlüter.
- Centralita termostática electrónica incluida (3 vías).
- Temperatura mínima disponible inferior a los 25°C.
- Sistema puesta a punto: Preparación de la temperatura deseada.
- Con programas antilegionela.



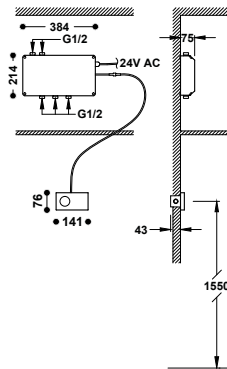

**Control termostático electrónico empotrado de 3 vías
Shower Technology Blue Edition**

- Control electrónico incluido con juntas antihumedad Schlüter.
- Centralita termostática electrónica incluida (3 vías).
- Temperatura mínima disponible inferior a los 25°C.
- Sistema puesta a punto: Preparación de la temperatura deseada.
- Con programas antilegionela.

	49286399	1.060,00
	49288399	1.060,00

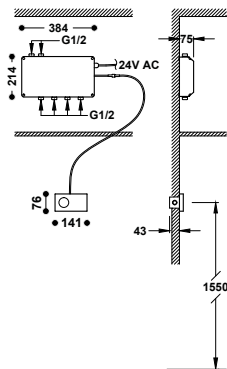

**Control termostático electrónico empotrado de 4 vías
Shower Technology Blue Edition**

- Control electrónico incluido con juntas antihumedad Schlüter.
- Centralita termostática electrónica incluida (4 vías).
- Temperatura mínima disponible inferior a los 25°C.
- Sistema puesta a punto: Preparación de la temperatura deseada.
- Con programas antilegionela.

	49286499	1.130,00
	49288499	1.130,00

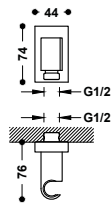

Soporte fijo con toma de agua para ducha de mano y flexo
Con toma de agua a pared. Válvula antirretorno. Material: Latón.

	20718201	70,00
	20718201NM	109,00
	20718201BM	109,00
	20718201AC	109,00
	20718201OR	140,00
	20718201OM	140,00
	20718201OPM	140,00 N

KITS DE 2 VÍAS

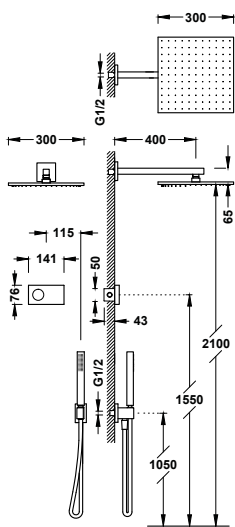

**Kit de grifo termostático electrónico empotrado de 2 vías
Shower Technology Blue Edition para ducha**

- Control electrónico incluido con juntas antihumedad Schlüter.
- Centralita termostática electrónica incluida (2 vías).
- Brazo a pared con rociador de ducha orientable y de acero inoxidable: 300x300 mm.
- Soporte para ducha de mano con toma de agua a pared.
- Ducha de mano anticálcarea de latón.
- Flexo satinado.

- 09286563 **1.183,00**
- 09286563OM **1.585,00** **N**
- 09286563OPM **1.858,00** **N**



- 09288563NM **1.282,00**

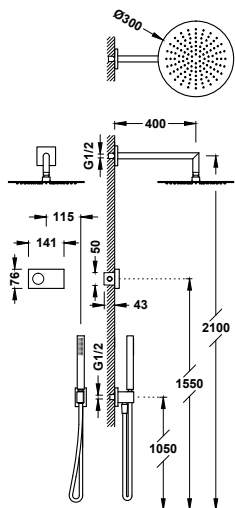

**Kit de grifo termostático electrónico empotrado de 2 vías
Shower Technology Blue Edition para ducha**

- Control electrónico incluido con juntas antihumedad Schlüter.
- Centralita termostática electrónica incluida (2 vías).
- Brazo a pared con rociador de ducha orientable y de acero inoxidable: Ø 300 mm.
- Soporte para ducha de mano con toma de agua a pared.
- Ducha de mano anticálcarea de latón.
- Flexo satinado.

- 09286558 **1.138,00**
- 09286558OM **1.529,00** **N**
- 09286558OPM **1.529,00** **N**



- 09288558NM **1.239,00**

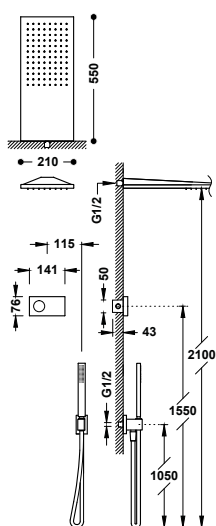

**Kit de grifo termostático electrónico empotrado de 2 vías
Shower Technology Blue Edition para ducha**

- Control electrónico incluido con juntas antihumedad Schlüter.
- Centralita termostática electrónica incluida de 2 vías.
- Rociador de ducha a pared de acero inoxidable: 210x550 mm.
- Soporte para ducha de mano con toma de agua a pared.
- Ducha de mano anticálcarea de latón.
- Flexo satinado.

- 09286551 **1.318,00**
- 09286551OM **2.041,00** **N**
- 09286551OPM **2.041,00** **N**



- 09288551NM **1.636,00**



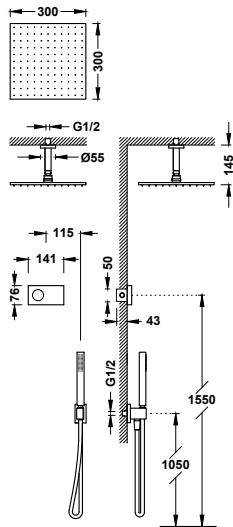

**Kit de grifo termostático electrónico empotrado de 2 vías
Shower Technology Blue Edition para ducha**

- Control electrónico incluido con juntas antihumedad Schlüter.
- Centralita termostática electrónica incluida (2 vías).
- Brazo a techo con rociador de ducha orientable y de acero inoxidable: 300x300 mm.
- Soporte para ducha de mano con toma de agua a pared.
- Ducha de mano anticalcárea de latón.
- Flexo satinado.

- 09286564 **1.133,00**
- 09286564OM **1.521,00**
- 09286564OPM **1.521,00**



- 09288564NM **1.234,00**

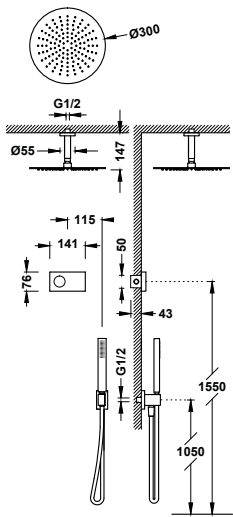

**Kit de grifo termostático electrónico empotrado de 2 vías
Shower Technology Blue Edition para ducha**

- Control electrónico incluido con juntas antihumedad Schlüter.
- Centralita termostática electrónica incluida (2 vías).
- Brazo a techo con rociador de ducha orientable y de acero inoxidable: Ø 300 mm.
- Soporte para ducha de mano con toma de agua a pared.
- Ducha de mano anticalcárea de latón.
- Flexo satinado.

- 09286567 **1.125,00**
- 09286567OM **1.465,00**
- 09286567OPM **1.465,00**



- 09288567NM **1.190,00**

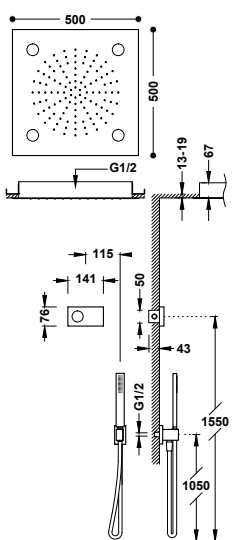

Kit de grifo termostático electrónico empotrado de 2 vías Shower Technology Blue Edition con Cromoterapia para ducha

- Control electrónico incluido con juntas antihumedad Schlüter.
- Centralita termostática electrónica incluida (2 vías).
- Rociador de ducha empotrado a techo con Cromoterapia de acero inoxidable: 500x500 mm.
- Soporte para ducha de mano con toma de agua a pared.
- Ducha de mano anticalcárea de latón.
- Flexo satinado.

- 09286562 **1.966,00**



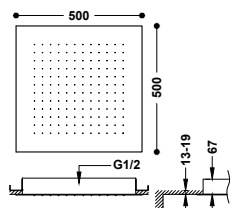

**Kit de grifo termostático electrónico empotrado de 2 vías
Shower Technology Blue Edition para ducha**

- Control electrónico incluido con juntas antihumedad Schlüter.
- Centralita termostática electrónica incluida (2 vías).
- Rociador de ducha empotrado a techo de acero inoxidable: 500x500 mm.
- Soporte para ducha de mano con toma de agua a pared.
- Ducha de mano anticalcárea de latón.
- Flexo satinado.

09286561 **1.682,00**



09288561NM **2.200,00**

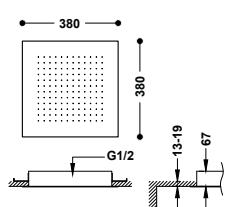
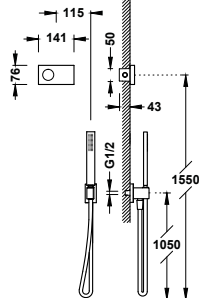

**Kit de grifo termostático electrónico empotrado de 2 vías
Shower Technology Blue Edition para ducha**

- Control electrónico incluido con juntas antihumedad Schlüter.
- Centralita termostática electrónica incluida (2 vías).
- Rociador de ducha empotrado a techo de acero inoxidable: 380x380 mm.
- Soporte para ducha de mano con toma de agua a pared.
- Ducha de mano anticalcárea de latón.
- Flexo satinado.

09286552 **1.540,00**



09288552NM **1.952,00**

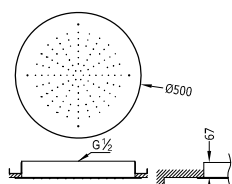
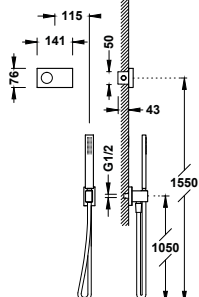

**Kit de grifo termostático electrónico empotrado de 2 vías
Shower Technology Blue Edition para ducha**

- Control electrónico incluido con juntas antihumedad Schlüter.
- Centralita termostática electrónica incluida (2 vías).
- Rociador de ducha empotrado a techo de acero inoxidable: Ø 500 mm.
- Soporte para ducha de mano con toma de agua a pared.
- Ducha de mano anticalcárea de latón.
- Flexo satinado.

09286557 **1.682,00**



09288557NM **2.190,00**

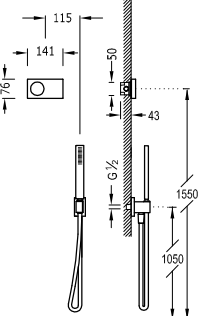

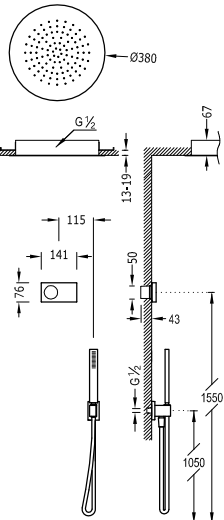

**Kit de grifo termostático electrónico empotrado de 2 vías
Shower Technology Blue Edition para ducha**

- Control electrónico incluido con juntas antihumedad Schlüter.
- Centralita termostática electrónica incluida (2 vías).
- Rociador de ducha empotrado a techo de acero inoxidable: Ø 380 mm.
- Soporte para ducha de mano con toma de agua a pared.
- Ducha de mano anticalcárea de latón.
- Flexo satinado.

09286555 **1.516,00**



09288555NM **1.942,00**



**Kit de grifo termostático electrónico empotrado de 2 vías
Shower Technology Blue Edition para bañera y ducha**

- Control electrónico incluido con juntas antihumedad Schlüter.
- Centralita termostática electrónica incluida (2 vías).
- Caño fijo de pared con salida en cascada.
- Soporte para ducha de mano con toma de agua a pared.
- Ducha de mano anticalcárea de latón.
- Flexo satinado.

09286556 **1.232,00**



09288556NM **1.502,00**

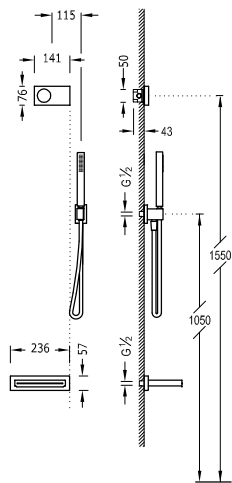

KITS DE 3 VÍAS

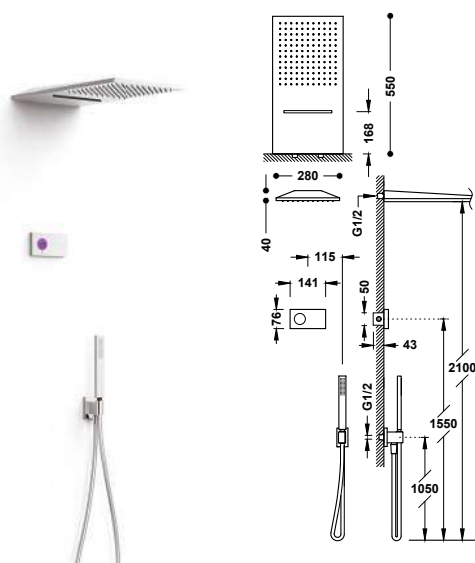

Kit de grifo termostático electrónico empotrado de 3 vías Shower Technology Blue Edition para ducha

- Control electrónico incluido con juntas antihumedad Schlüter.
- Centralita termostática electrónica incluida (3 vías).
- Rociador de ducha a pared de acero inoxidable con 2 tipos de chorro (lluvia/cascada). 280x550 mm. **IMPORTANTE:** Montar un desagüe de >50 l/min.
- Soporte para ducha de mano con toma de agua a pared.
- Ducha de mano anticalcárea de latón.
- Flexo satinado.

- 09286308 **1.534,00**
- 09286308OM **2.361,00**
- 09286308OPM **2.361,00**
- 09288308NM **1.884,00**

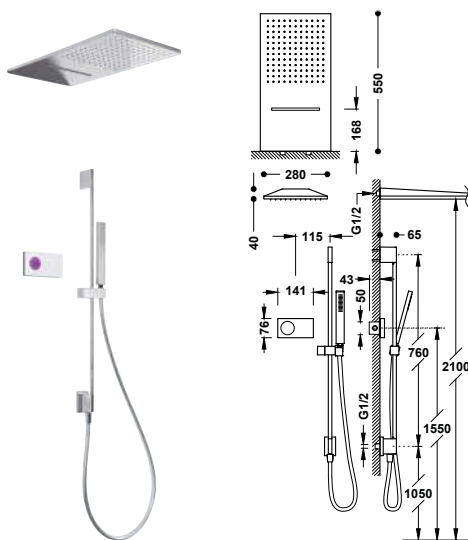

Kit de grifo termostático electrónico empotrado de 3 vías Shower Technology Blue Edition para ducha

- Control electrónico incluido con juntas antihumedad Schlüter.
- Centralita termostática electrónica incluida (3 vías).
- Rociador de ducha a pared de acero inoxidable con 2 tipos de chorro (lluvia/cascada). 280x550 mm. **IMPORTANTE:** Montar un desagüe de >50 l/min.
- Barra deslizante para ducha con toma de agua a pared.
- Ducha de mano anticalcárea de latón.
- Flexo satinado.

- 09286307 **1.598,00**

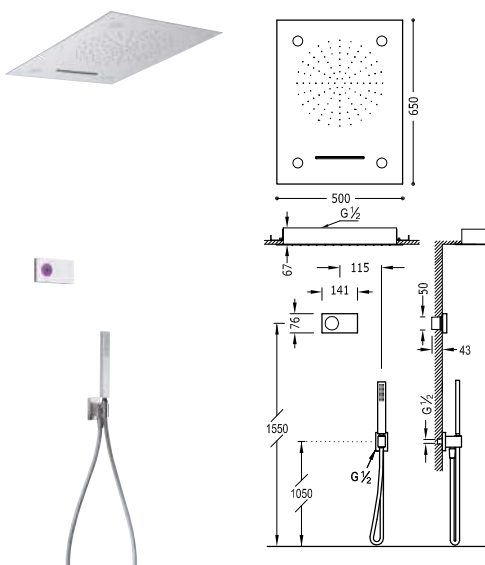

Kit de grifo termostático electrónico empotrado de 3 vías Shower Technology Blue Edition con Cromoterapia para ducha

- Control electrónico incluido con juntas antihumedad Schlüter.
- Centralita termostática electrónica incluida (3 vías).
- Rociador de ducha empotrado a techo con Cromoterapia de acero inoxidable con 2 tipos de chorro (lluvia/cascada). 500x650 mm. **IMPORTANTE:** Montar un desagüe de >50 l/min.
- Soporte para ducha de mano con toma de agua a pared.
- Ducha de mano anticalcárea de latón.
- Flexo satinado.

- 09286302 **2.862,00**



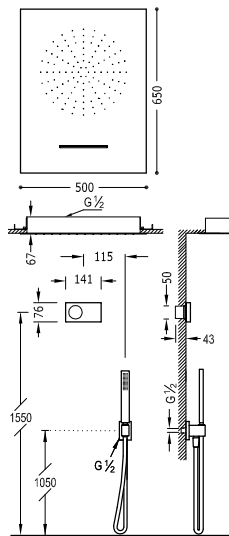

**Kit de grifo termostático electrónico empotrado de 3 vías
Shower Technology Blue Edition para ducha**

09286304

2.142,00



- Control electrónico incluido con juntas antihumedad Schlüter.
- Centralita termostática electrónica incluida (3 vías).
- Rociador de ducha empotrado a techo de acero inoxidable con 2 tipos de chorro (lluvia/cascada). 500x650 mm. IMPORTANTE: Montar un desagüe de >50 l/min.
- Soporte para ducha de mano con toma de agua a pared.
- Ducha de mano anticalcárea de latón.
- Flexo satinado.

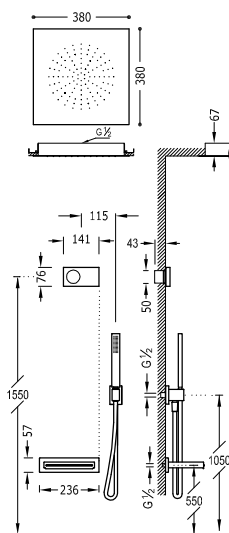

**Kit de grifo termostático electrónico empotrado de 3 vías
Shower Technology Blue Edition para bañera y ducha**

09286315

1.910,00



- Control electrónico incluido con juntas antihumedad Schlüter.
- Centralita termostática electrónica incluida (3 vías).
- Rociador de ducha empotrado a techo de acero inoxidable: 380x380 mm. IMPORTANTE: Montar un desagüe de >50 l/min.
- Caño fijo de pared con salida en cascada.
- Soporte para ducha de mano con toma de agua a pared.
- Ducha de mano anticalcárea de latón.
- Flexo satinado.



09288315NM

2.523,00



KITS DE 4 VÍAS

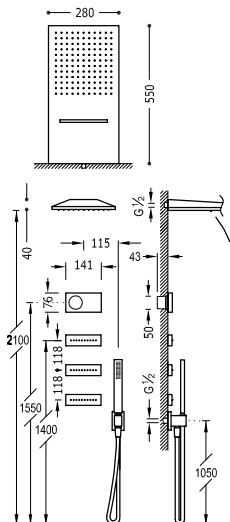

Kit de grifo termostático electrónico empotrado de 4 vías Shower Technology Blue Edition para ducha

- Control electrónico incluido con juntas antihumedad Schlüter.
- Centralita termostática electrónica incluida (4 vías).
- Rociador de ducha a pared de acero inoxidable con 2 tipos de chorro (lluvia/cascada). 280x550 mm. IMPORTANTE: Montar un desagüe de >50 l/min.
- 3 jets empotrados de hidromasaje de latón.
- Soporte para ducha de mano con toma de agua a pared.
- Ducha de mano anticalcárea de latón.
- Flexo satinado.

09286408 **2.118,00**



09288408NM **2.758,00**

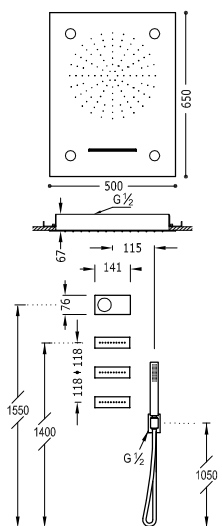

Kit de grifo termostático electrónico empotrado de 4 vías Shower Technology Blue Edition con Cromoterapia para ducha

- Control electrónico incluido con juntas antihumedad Schlüter.
- Centralita termostática electrónica incluida (4 vías).
- Rociador de ducha empotrado a techo con Cromoterapia de acero inoxidable con 2 tipos de chorro (lluvia/cascada). 500x650 mm. IMPORTANTE: Montar un desagüe de >50 l/min.
- 3 jets empotrados de hidromasaje de latón.
- Soporte para ducha de mano con toma de agua a pared.
- Ducha de mano anticalcárea de latón.
- Flexo satinado.

09286402 **3.446,00**

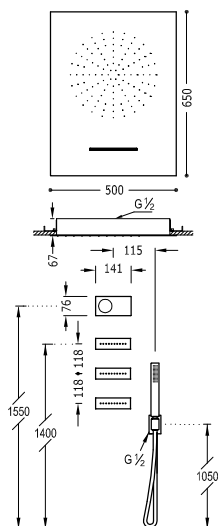

Kit de grifo termostático electrónico empotrado de 4 vías Shower Technology Blue Edition para ducha

- Control electrónico incluido con juntas antihumedad Schlüter.
- Centralita termostática electrónica incluida (4 vías).
- Rociador de ducha empotrado a techo de acero inoxidable con 2 tipos de chorro (lluvia/cascada). 500x650 mm. IMPORTANTE: Montar un desagüe de >50 l/min.
- 3 jets empotrados de hidromasaje de latón.
- Soporte para ducha de mano con toma de agua a pared.
- Ducha de mano anticalcárea de latón.
- Flexo satinado.

09286404 **2.726,00**



09288404NM **3.577,00**



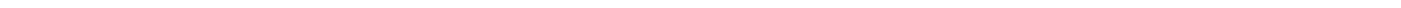



B-SYSTEM

La colección de termostáticas empotradas B-system se caracteriza por su diseño refinado de líneas sobrias con el cuerpo ligeramente separado de la pared para dar una sensación de flotabilidad. La caja empotrada interior permite una instalación más limpia y simple. B-system es elegancia y confort en la ducha.

Acabados disponibles:



TRES



B-system

Diseñado para el placer del agua

La caja empotrada está incluida en cada pieza vista (no se suministra por separado).

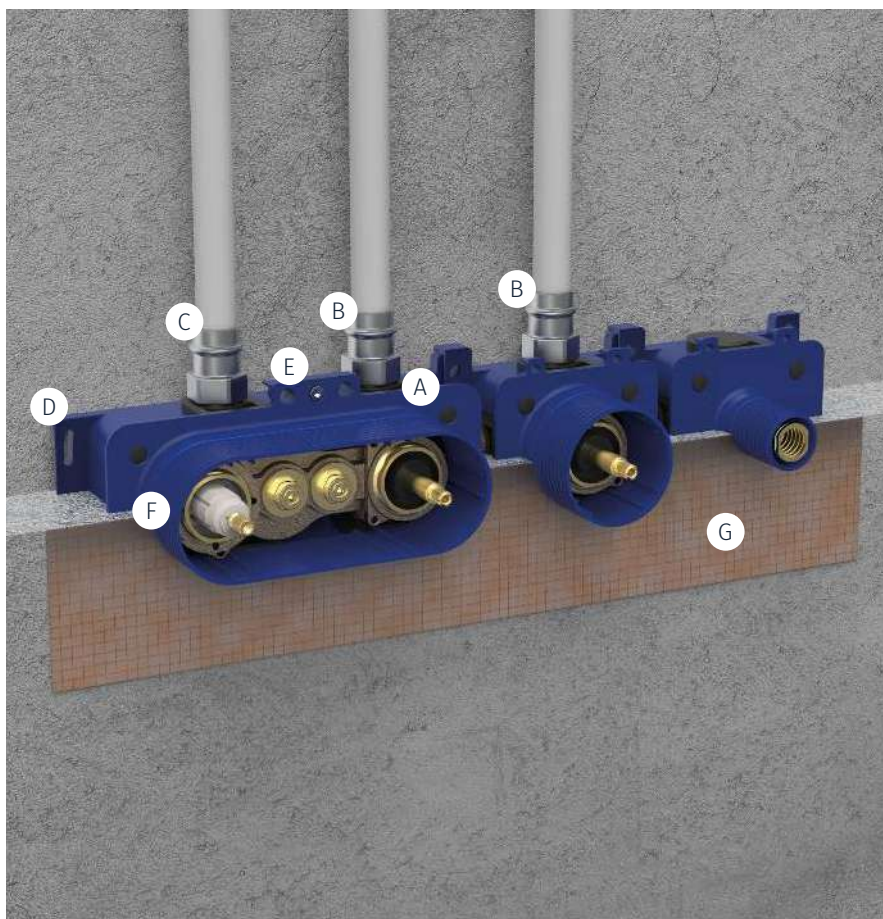

- Ⓐ Amortiguadores acústicos
- Ⓑ Salida de agua G1/2"
- Ⓒ Entrada de agua G1/2"
- Ⓓ Soportes para instalación delantera
- Ⓔ Soportes para instalación trasera
- Ⓕ Marcas de profundidad y ranuras de corte
- Ⓖ Junta de impermeabilización Schlüter®

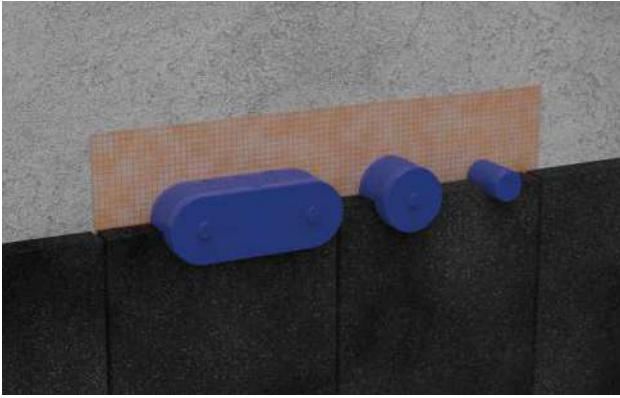

CAJA EMPOTRADA

Instalación versátil

La caja empotrada permite instalarse por delante o por detrás de la pared, tanto en paredes de obra como paredes ligeras de cartón y yeso (tipo Pladur).

Aislamiento del cuerpo

La caja aísla la transmisión de temperatura del cuerpo de latón hacia la pared. Asimismo, al ser estanca, evita que en caso de fuga el agua se filtre por la pared. La junta impermeable evita las humedades.

Bajo nivel de ruido

Los amortiguadores evitan la transmisión del ruido del grifo a la pared y a la tuberías.

Cartucho Tres Therm 77®

El cartucho garantiza un caudal de agua constante a la temperatura deseada de ± 1 grado ante variaciones de presión y/o temperatura. Concebido para la desinfección de la legionela.



PARTE VISTA

Mayor espacio en la ducha

Las piezas vistas tienen poca profundidad, permitiendo ganar más espacio útil dentro de la ducha.

Diseño ligero y refinado

El florón está ligeramente separado de la pared para dar una sensación de flotabilidad y adaptarse fácilmente a paredes irregulares. El diseño acurado aporta refinamiento y perfección en la composición del espacio de ducha.

Control preciso de la temperatura

El botón de seguridad restringe la temperatura a 38°C para evitar quemaduras. Si se desea aumentar la temperatura del agua basta con presionar el botón y girar el volante.

De 2 a 4 salidas de agua

Con un sencillo giro del distribuidor se puede escoger la salida de agua deseada.



GRIFOS TERMOSTÁTICOS EMPOTRADOS

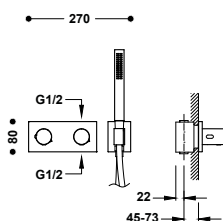

Grifo termostático empotrado de 2 vías B-system

- Cuerpo empotrado termostático de instalación horizontal incluido.
- Regulador de caudal y distribuidor cerámico de 2 vías.
- Volante redondo.
- Soporte para ducha de mano con toma de agua a pared.
- Ducha móvil anticalcárea de latón.
- Flexo satinado.

	30735201	600,00
	30735201NM	930,00
	30735201AC	930,00
	30735201OR	1.200,00
	30735201OM	1.200,00
	30735201OP	1.200,00
	30735201OPM	1.200,00

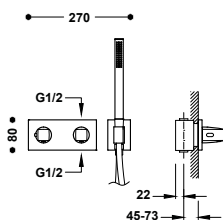

Grifo termostático empotrado de 2 vías B-system

- Cuerpo empotrado termostático de instalación horizontal incluido.
- Regulador de caudal y distribuidor cerámico de 2 vías.
- Volante cuadrado-redondo.
- Soporte para ducha de mano con toma de agua a pared.
- Ducha móvil anticalcárea de latón.
- Flexo satinado.

	30725201	620,00
	30725201NM	961,00
	30725201AC	961,00
	30725201OR	1.240,00
	30725201OM	1.240,00
	30725201OP	1.240,00
	30725201OPM	1.240,00

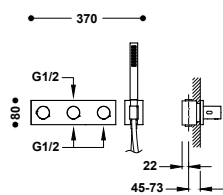

Grifo termostático empotrado de 3 vías B-system

- Cuerpo empotrado termostático de instalación horizontal incluido.
- Regulador de caudal y distribuidor de 3 vías.
- Volante redondo.
- Soporte para ducha de mano con toma de agua a pared.
- Ducha móvil anticalcárea de latón.
- Flexo satinado.

	30735301	700,00
	30735301NM	1.085,00
	30735301AC	1.085,00
	30735301OR	1.400,00
	30735301OM	1.400,00
	30735301OP	1.400,00
	30735301OPM	1.400,00

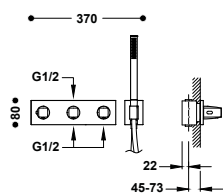

Grifo termostático empotrado de 3 vías B-system

- Cuerpo empotrado termostático de instalación horizontal incluido.
- Regulador de caudal y distribuidor de 3 vías.
- Volante cuadrado-redondo.
- Soporte para ducha de mano con toma de agua a pared.
- Ducha móvil anticalcárea de latón.
- Flexo satinado.

	30725301	720,00
	30725301NM	1.116,00
	30725301AC	1.116,00
	30725301OR	1.440,00
	30725301OM	1.440,00
	30725301OP	1.440,00
	30725301OPM	1.440,00



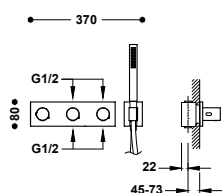

Grifo termostático empotrado de 4 vías B-system

- Cuerpo empotrado termostático de instalación horizontal incluido.
- Regulador de caudal y distribuidor de 4 vías.
- Volante redondo.
- Soporte para ducha de mano con toma de agua a pared.
- Ducha móvil anticalcárea de latón.
- Flexo satinado.



	30735401	700,00
	30735401NM	1.085,00
	30735401AC	1.085,00
	30735401OR	1.400,00
	30735401OM	1.400,00
	30735401OP	1.400,00
	30735401OPM	1.400,00

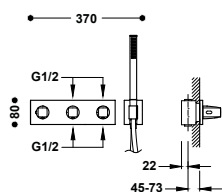

Grifo termostático empotrado de 4 vías B-system

- Cuerpo empotrado termostático de instalación horizontal incluido.
- Regulador de caudal y distribuidor de 4 vías.
- Volante cuadrado-redondo.
- Soporte para ducha de mano con toma de agua a pared.
- Ducha móvil anticalcárea de latón.
- Flexo satinado.



	30725401	720,00
	30725401NM	1.116,00
	30725401AC	1.116,00
	30725401OR	1.440,00
	30725401OM	1.440,00
	30725401OP	1.440,00
	30725401OPM	1.440,00

KITS DE 2 VÍAS

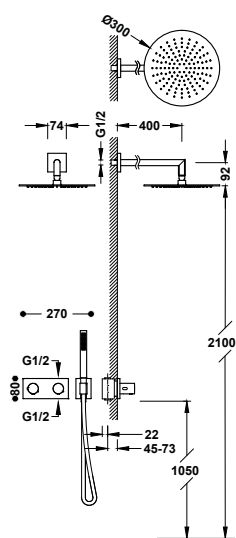

Kit de grifo termostático empotrado de 2 vías B-system para ducha

- Cuerpo empotrado termostático de instalación horizontal incluido.
- Regulador de caudal y distribuidor cerámico de 2 vías.
- Volante redondo.
- Brazo a pared con rociador de ducha orientable y de acero inoxidable: Ø 300 mm.
- Soporte para ducha de mano con toma de agua a pared.
- Ducha de mano anticalcárea de latón.
- Flexo satinado.





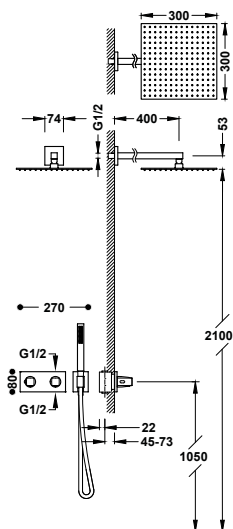



	30735204	803,00
	30735204NM	1.245,00
	30735204AC	1.245,00
	30735204OR	1.606,00
	30735204OM	1.606,00
	30735204OP	1.606,00
	30735204OPM	1.606,00



Kit de grifo termostático empotrado de 2 vías B-system para ducha





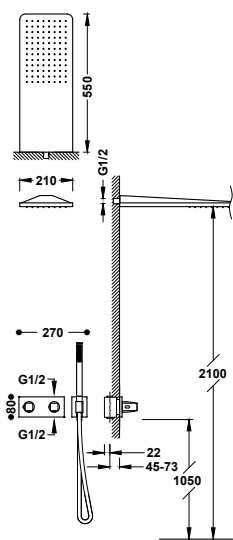

- Cuerpo empotrado termostático de instalación horizontal incluido.
- Regulador de caudal y distribuidor cerámico de 2 vías.
- Volante cuadrado-redondo.
- Brazo a pared con rociador de ducha orientable y de acero inoxidable: 300x300 mm.
- Soporte para ducha de mano con toma de agua a pared.
- Ducha de mano anticálrea de latón.
- Flexo satinado.

	30725204	859,00
	30725204NM	1.331,00
	30725204AC	1.331,00
	30725204OR	1.718,00
	30725204OM	1.718,00
	30725204OP	1.718,00
	30725204OPM	1.718,00



Kit de grifo termostático empotrado de 2 vías B-system para ducha





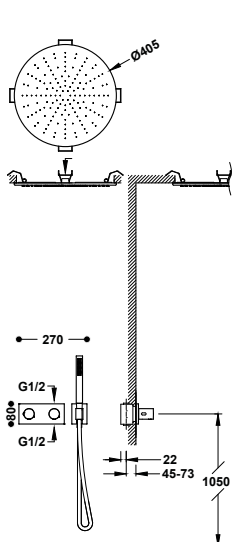

- Cuerpo empotrado termostático de instalación horizontal incluido.
- Regulador de caudal y distribuidor cerámico de 2 vías.
- Volante cuadrado-redondo.
- Rociador de ducha a pared de acero inoxidable: 210x550 mm.
- Soporte para ducha de mano con toma de agua a pared.
- Ducha de mano anticálrea de latón.
- Flexo satinado.

	30725205	1.187,00
	30725205NM	1.840,00
	30725205AC	1.840,00
	30725205OR	2.374,00
	30725205OM	2.374,00
	30725205OP	2.374,00
	30725205OPM	2.374,00



Kit de grifo termostático empotrado de 2 vías B-system para ducha

- Cuerpo empotrado termostático de instalación horizontal incluido.
- Regulador de caudal y distribuidor cerámico de 2 vías.
- Volante redondo.
- Rociador de ducha empotrado a techo de acero inoxidable: Ø 405 mm.
- Soporte para ducha de mano con toma de agua a pared.
- Ducha de mano anticálrea de latón.
- Flexo satinado.





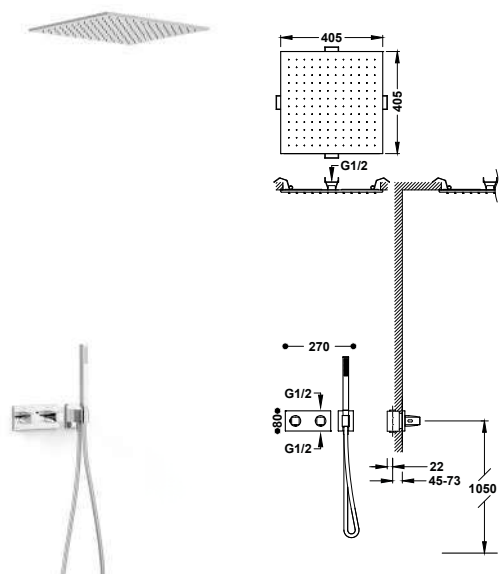

	30735206	1.309,00
	30735206NM	2.029,00
	30735206AC	2.029,00
	30735206OR	2.618,00
	30735206OM	2.618,00
	30735206OP	2.618,00
	30735206OPM	2.618,00





Kit de grifo termostático empotrado de 2 vías B-system para ducha







- Cuerpo empotrado termostático de instalación horizontal incluido.
- Regulador de caudal y distribuidor cerámico de 2 vías.
- Volante cuadrado-redondo.
- Rociador de ducha empotrado a techo de acero inoxidable: 405x405 mm.
- Soporte para ducha de mano con toma de agua a pared.
- Ducha de mano anticalcárea de latón.
- Flexo satinado.

	30725206	1.377,00
	30725206NM	2.134,00
	30725206AC	2.134,00
	30725206OR	2.754,00
	30725206OM	2.754,00
	30725206OP	2.754,00
	30725206PM	2.754,00



Kit de grifo termostático empotrado de 2 vías B-system para bañera y ducha

- Cuerpo empotrado termostático de instalación horizontal incluido.
- Regulador de caudal y distribuidor cerámico de 2 vías.
- Volante cuadrado-redondo.
- Caño fijo de pared con salida en cascada.
- Soporte para ducha de mano con toma de agua a pared.
- Ducha de mano anticalcárea de latón.
- Flexo satinado.

	30725207	1.197,00
	30725207NM	1.855,00
	30725207AC	1.855,00
	30725207OR	2.394,00
	30725207OM	2.394,00
	30725207OP	2.394,00
	30725207PM	2.394,00

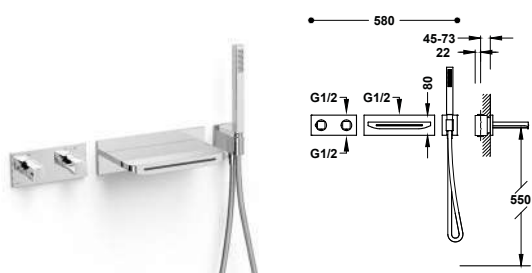



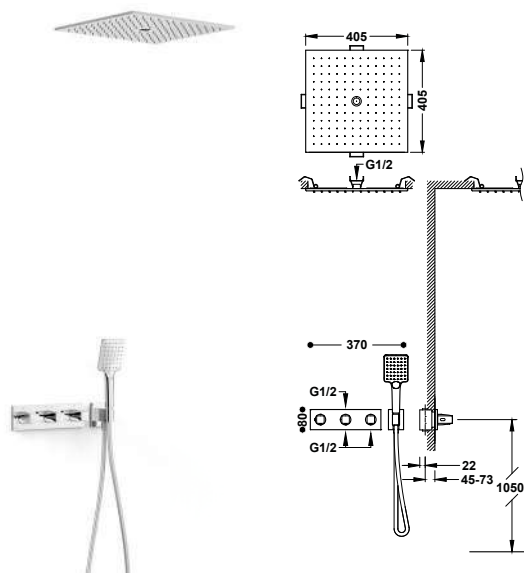



KITS DE 3 VÍAS



Kit de grifo termostático empotrado de 3 vías B-system para ducha

- Cuerpo empotrado termostático de instalación horizontal incluido.
- Regulador de caudal y distribuidor de 3 vías.
- Volante cuadrado-redondo.
- Rociador de ducha empotrado a techo de acero inoxidable con 2 tipos de chorro (lluvia/free flow). 405x405 mm.
- Soporte para ducha de mano con toma de agua a pared.
- Ducha de mano anticalcárea: 96x110 mm. (3 tipos de chorro).
- Flexo satinado.

	30725306	1.543,00
	30725306NM	2.392,00
	30725306AC	2.392,00
	30725306OR	3.086,00
	30725306OM	3.086,00
	30725306OP	3.086,00
	30725306PM	3.086,00



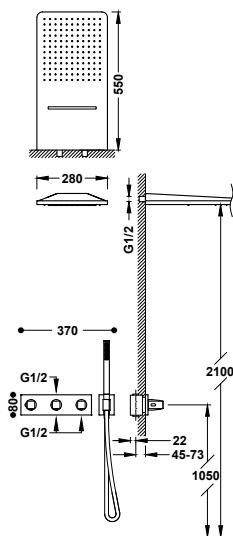

Kit de grifo termostático empotrado de 3 vías B-system para ducha

- Cuerpo empotrado termostático de instalación horizontal incluido.
- Regulador de caudal y distribuidor de 3 vías.
- Volante cuadrado-redondo.
- Rociador de ducha a pared de acero inoxidable con 2 tipos de chorro (lluvia/cascada). 280x550 mm. IMPORTANTE: Montar un desagüe de >50 l/min.
- Soporte para ducha de mano con toma de agua a pared.
- Ducha de mano anticalcárea de latón.
- Flexo satinado.

	30725305	1.477,00
	30725305NM	2.289,00
	30725305AC	2.289,00
	30725305OR	2.954,00
	30725305OM	2.954,00
	30725305OP	2.954,00
	30725305OPM	2.954,00



KITS DE 4 VÍAS

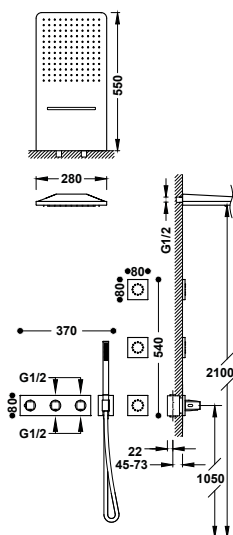

Kit de grifo termostático empotrado de 4 vías B-system para ducha

- Cuerpo empotrado termostático de instalación horizontal incluido.
- Regulador de caudal y distribuidor de 4 vías.
- Volante cuadrado-redondo.
- Rociador de ducha a pared de acero inoxidable con 2 tipos de chorro (lluvia/cascada). 280x550 mm. IMPORTANTE: Montar un desagüe de >50 l/min.
- 3 jets empotrados de hidromasaje.
- Soporte para ducha de mano con toma de agua a pared.
- Ducha de mano anticalcárea de latón.
- Flexo satinado.

	30725405	1.904,00
	30725405NM	2.951,00
	30725405AC	2.951,00
	30725405OR	3.808,00
	30725405OM	3.808,00
	30725405OP	3.808,00
	30725405OPM	3.808,00

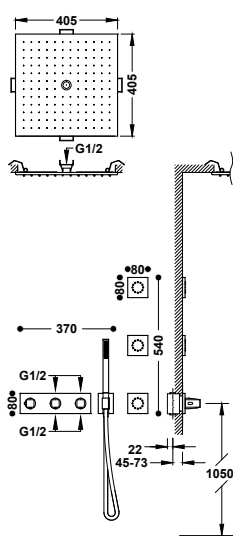

Kit de grifo termostático empotrado de 4 vías B-system para ducha

- Cuerpo empotrado termostático de instalación horizontal incluido.
- Regulador de caudal y distribuidor de 4 vías.
- Volante cuadrado-redondo.
- Rociador de ducha empotrado a techo de acero inoxidable con 2 tipos de chorro (lluvia/free flow). 405x405 mm.
- 3 jets empotrados de hidromasaje.
- Soporte para ducha de mano con toma de agua a pared.
- Ducha de mano anticalcárea de latón.
- Flexo satinado.

	30725406	1.971,00
	30725406NM	3.055,00
	30725406AC	3.055,00
	30725406OR	3.942,00
	30725406OM	3.942,00
	30725406OP	3.942,00
	30725406OPM	3.942,00







THERM-BOX

Therm-box es el sistema empotrado de Tres para los grifos termostáticos de ducha. Control total de la temperatura con un diseño compacto. Se puede adquirir la caja empotrada y la parte vista por separado; de esta manera, la planificación de la obra se simplifica y se gana en eficacia.

Acabados disponibles:





Therm-box

Un único cuerpo empotrado para los grifos termostáticos de ducha de Tres

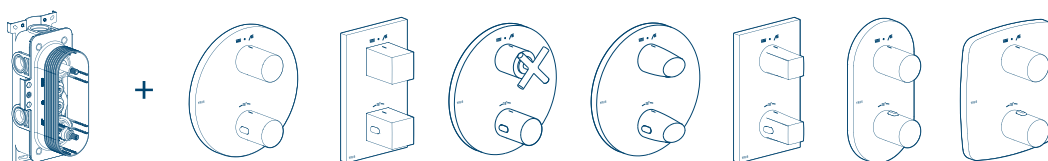

Compra e instala por separado

Puedes instalar la caja Therm-box y, posteriormente, adquirir la parte vista para instalarla cuando esté todo listo. De esta manera, la planificación de la obra se simplifica y se gana en eficacia.

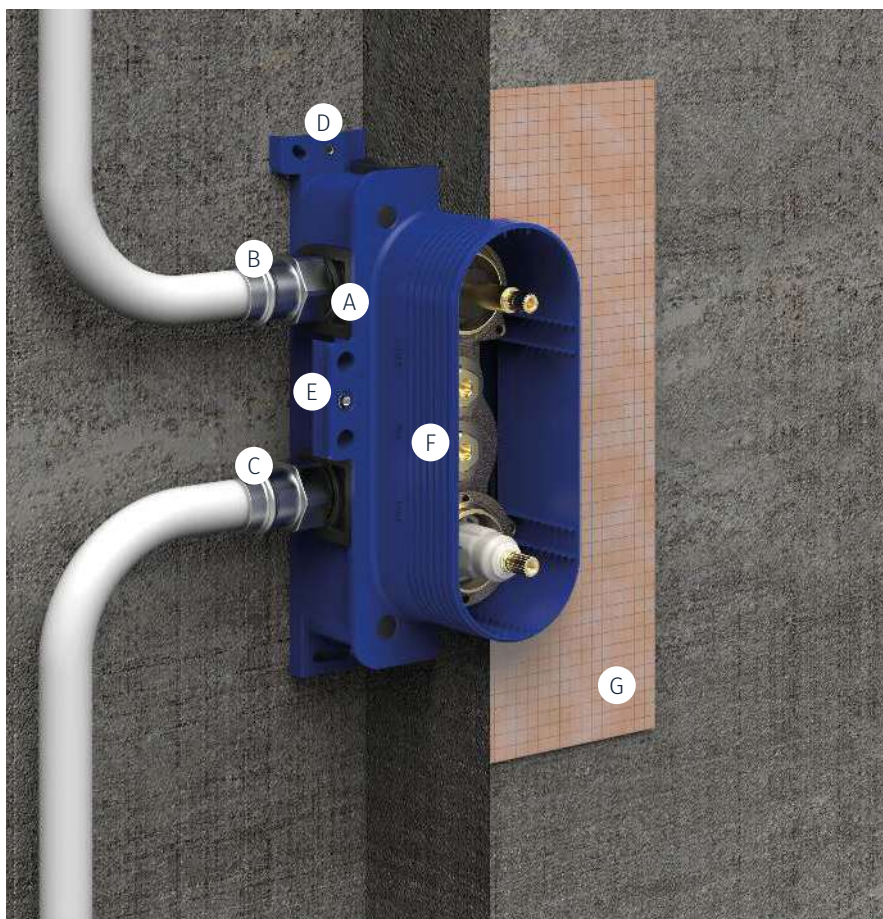

- Ⓐ Amortiguadores acústicos
- Ⓑ Salida de agua G1/2"
- Ⓒ Entrada de agua G1/2"
- Ⓓ Soportes para instalación delantera
- Ⓔ Soportes para instalación trasera
- Ⓕ Marcas de profundidad y ranuras de corte
- Ⓖ Junta de impermeabilización Schlüter®

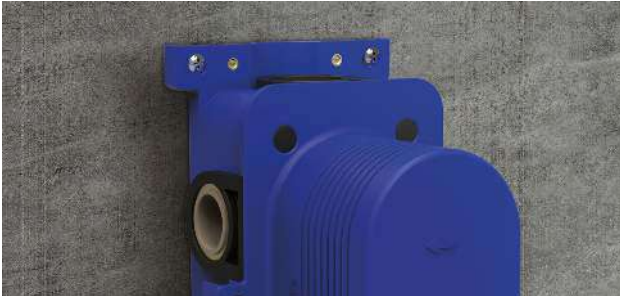

CAJA EMPOTRADA

Instalación versátil

La caja empotrada Therm-box permite instalarse por delante o por detrás de la pared, tanto en paredes de obra como paredes ligeras de cartón y yeso (tipo Pladur).

Aislamiento del cuerpo

La caja Therm-box aísla la transmisión de temperatura del cuerpo de latón hacia la pared. Asimismo, al ser estanca, evita que en caso de fuga el agua se filtre por la pared. La junta impermeable evita las humedades.

Bajo nivel de ruido

Los amortiguadores evitan la transmisión del ruido del grifo a la pared y a la tuberías.



PARTE VISTA

Mayor espacio en la ducha

Las piezas vistas tienen poca profundidad, permitiendo ganar más espacio útil dentro de la ducha.

Diseños adaptables

Las piezas vistas están disponibles en varios acabados y distintos diseños que combinan con las colecciones de Tres.

Control preciso de la temperatura

El botón de seguridad restringe la temperatura a 38°C para evitar quemaduras. Si se desea aumentar la temperatura del agua basta con presionar el botón y girar el volante.

2 salidas de agua

Con un sencillo giro del distribuidor se puede cambiar entre las 2 salidas de agua disponibles.

CAJA EMPOTRADA

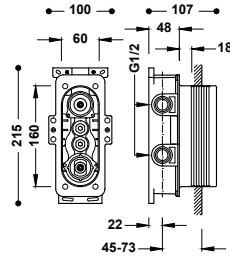

Caja empotrada de 2 vías Therm-box con grifo termostático para ducha y bañera

20785001

130,00

Cuerpo empotrado con amortiguadores acústicos. Caja de empotrar de ABS. Junta antihumedad. Distribuidor cerámico de 2 vías.



PIEZAS VISTAS DE 2 VÍAS

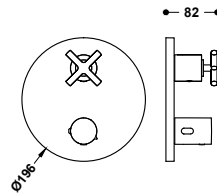

Pieza vista para caja empotrada de 2 vías Therm-box

Sólo parte vista. Volante en cruz. Incluye placa embellecedora, mando y volante distribuidor. Completar con la caja empotrada Therm-box ref.: 20785001.

- 28325001 **170,00**
- 28325001NM **264,00**
- 28325001AC **264,00**
- 28325001OM **340,00**
- 28325001OPM **340,00**

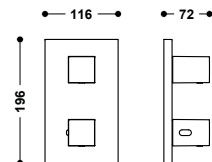

Pieza vista para caja empotrada de 2 vías Therm-box

Sólo parte vista. Volante cuadrado. Incluye placa embellecedora, mando y volante distribuidor. Completar con la caja empotrada Therm-box ref.: 20785001.

- 00625001 **130,00**
- 00625001NM **202,00**
- 00625001BM **202,00**
- 00625001AC **202,00**
- 00625001OR **260,00**
- 00625001OM **260,00**

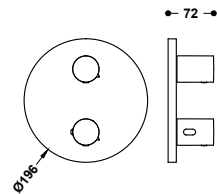

Pieza vista para caja empotrada de 2 vías Therm-box

Sólo parte vista. Volante redondo. Incluye placa embellecedora, mando y volante distribuidor. Completar con la caja empotrada Therm-box ref.: 20785001.

- 26225001 **130,00**
- 26225001NM **202,00**
- 26225001BM **202,00**
- 26225001AC **202,00**
- 26225001KM **202,00**
- 26225001KMB **202,00**
- 26225001OR **260,00**
- 26225001OM **260,00**
- 26225001OP **260,00**
- 26225001OPM **260,00**



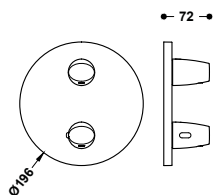

Pieza vista para caja empotrada de 2 vías Therm-box

Sólo parte vista. Volante ovalado. Incluye placa embellecedora, mando y volante distribuidor. Completar con la caja empotrada Therm-box ref.: 20785001.

- 28125001 **110,00**
- 28125001NM **171,00**
- 28125001AC **171,00**

THERM
BOX

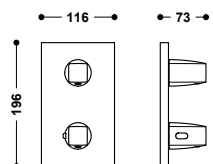

Pieza vista para caja empotrada de 2 vías Therm-box

Sólo parte vista. Volante cuadrado-redondo. Incluye placa embellecedora, mando y volante distribuidor. Completar con la caja empotrada Therm-box ref.: 20785001.

- 21125001 **110,00**
- 21125001NM **171,00**
- 21125001BM **171,00**
- 21125001AC **171,00**
- 21125001KM **171,00**
- 21125001KMB **171,00**
- 21125001OR **220,00**
- 21125001OM **220,00**
- 21125001OP **220,00**
- 21125001OPM **220,00**

THERM
BOX

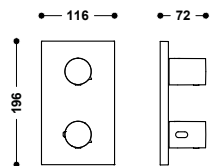

Pieza vista para caja empotrada de 2 vías Therm-box

Sólo parte vista. Volante redondo. Incluye placa embellecedora, mando y volante distribuidor. Completar con la caja empotrada Therm-box ref.: 20785001.

- 06225001 **110,00**

THERM
BOX

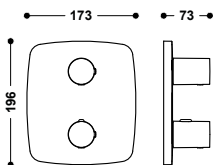

Pieza vista para caja empotrada de 2 vías Therm-box

Sólo parte vista. Volante redondo de ABS. Incluye placa embellecedora, mando y volante distribuidor. Completar con la caja empotrada Therm-box ref.: 20785001.

- 21725001 **85,00**

THERM
BOX

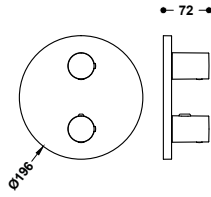

Pieza vista para caja empotrada de 2 vías Therm-box

Sólo parte vista. Volante redondo de ABS. Incluye placa embellecedora, mando y volante distribuidor. Completar con la caja empotrada Therm-box ref.: 20785001.

20425001

85,00

THERM
BOX

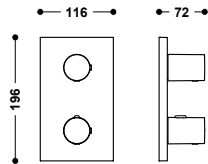

Pieza vista para caja empotrada de 2 vías Therm-box

Sólo parte vista. Volante redondo de ABS. Incluye placa embellecedora, mando y volante distribuidor. Completar con la caja empotrada Therm-box ref.: 20785001.

21625001

80,00

21625001NM

124,00

THERM
BOX

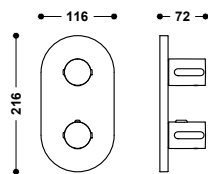

Pieza vista para caja empotrada de 2 vías Therm-box

Sólo parte vista. Volante redondo de ABS. Incluye placa embellecedora, mando y volante distribuidor. Completar con la caja empotrada Therm-box ref.: 20785001.

21525001

80,00

THERM
BOX

KITS TERMOSTÁTICOS DE 2 VÍAS

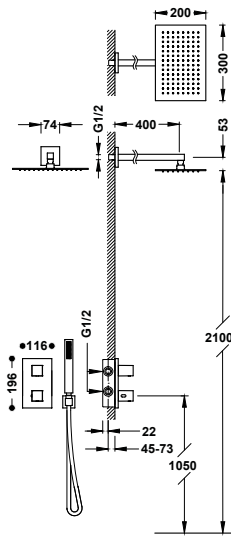

Kit de grifo termostático empotrado de 2 vías Therm-box para ducha

- Cuerpo empotrado incluido.
- Volante cuadrado con control de temperatura. Distribuidor cerámico de 2 vías.
- Brazo a pared con rociador de ducha orientable y de acero inoxidable: 300x200 mm.
- Soporte para ducha de mano con toma de agua a pared.
- Ducha de mano anticalcárea de latón.
- Flexo satinado.

	20225054	659,00
	20225054NM	1.021,00
	20225054BM	1.021,00
	20225054AC	1.021,00
	20225054OR	1.318,00
	20225054OM	1.318,00



29926828

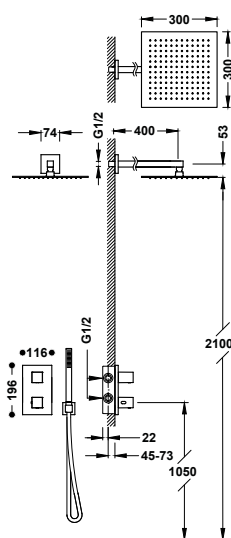

Kit de grifo termostático empotrado de 2 vías Therm-box para ducha

- Cuerpo empotrado incluido.
- Volante cuadrado con control de temperatura. Distribuidor cerámico de 2 vías.
- Brazo a pared con rociador de ducha orientable y de acero inoxidable: 300x300 mm.
- Soporte para ducha de mano con toma de agua a pared.
- Ducha de mano anticalcárea de latón.
- Flexo satinado.

	00625004	624,00
	00625004NM	967,00
	00625004BM	967,00
	00625004AC	967,00
	00625004OR	1.248,00
	00625004OM	1.248,00



29926828

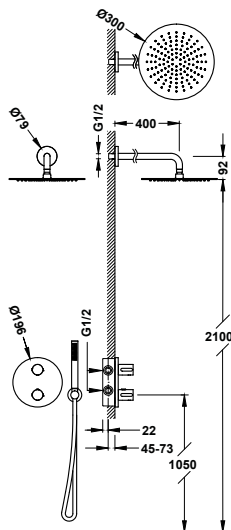

Kit de grifo termostático empotrado de 2 vías Therm-box para ducha

- Cuerpo empotrado incluido.
- Volante redondo con control de temperatura. Distribuidor cerámico de 2 vías.
- Brazo a pared con rociador de ducha orientable y de acero inoxidable: Ø 300 mm.
- Soporte para ducha de mano con toma de agua a pared.
- Ducha de mano anticalcárea de latón.
- Flexo satinado.

	26225004	571,00
	26225004NM	885,00
	26225004BM	885,00
	26225004AC	885,00
	26225004KM	885,00
	26225004KMB	885,00
	26225004OR	1.142,00
	26225004OM	1.142,00
	26225004OP	1.142,00
	26225004OPM	1.142,00



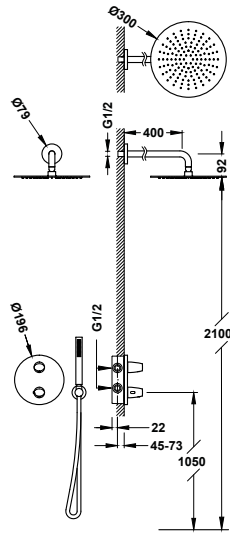

29926828



Kit de grifo termostático empotrado de 2 vías Therm-box para ducha

- Cuerpo empotrado incluido.
- Volante ovalado con control de temperatura. Distribuidor cerámico de 2 vías.
- Brazo a pared con rociador de ducha orientable y de acero inoxidable: Ø 300 mm.
- Soporte para ducha de mano con toma de agua a pared.
- Ducha de mano anticalcárea de latón.
- Flexo satinado.

	28125004	551,00
	28125004NM	854,00
	28125004AC	854,00

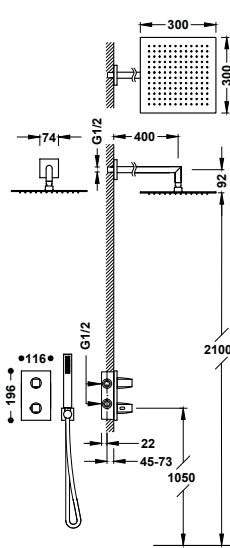

Kit de grifo termostático empotrado de 2 vías Therm-box para ducha

- Cuerpo empotrado incluido.
- Volante cuadrado-redondo con control de temperatura. Distribuidor cerámico de 2 vías.
- Brazo a pared con rociador de ducha orientable y de acero inoxidable: 300x300 mm.
- Soporte para ducha de mano con toma de agua a pared.
- Ducha de mano anticalcárea de latón.
- Flexo satinado.

	21125004	592,00
	21125004NM	918,00
	21125004BM	918,00
	21125004AC	918,00
	21125004KM	918,00
	21125004KMB	918,00
	21125004OR	1.184,00
	21125004OM	1.184,00
	21125004OP	1.184,00
	21125004OPM	1.184,00

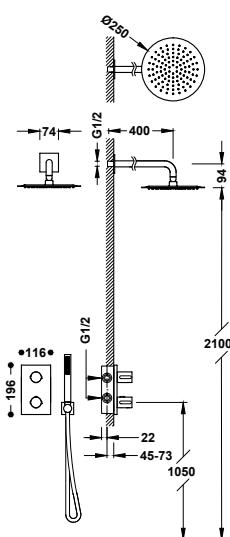

Kit de grifo termostático empotrado de 2 vías Therm-box para ducha

- Cuerpo empotrado incluido.
- Volante redondo con control de temperatura. Distribuidor cerámico de 2 vías.
- Brazo a pared con rociador de ducha orientable y de acero inoxidable: Ø 250 mm.
- Soporte para ducha de mano con toma de agua a pared.
- Ducha de mano anticalcárea de latón.
- Flexo satinado.

	06225004	516,00
---	----------	---------------



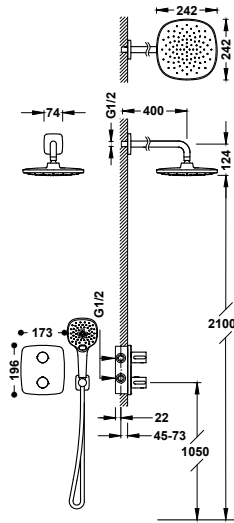

Kit de grifo termostático empotrado de 2 vías Therm-box para ducha

21725004

419,00

- Cuerpo empotrado incluido.
- Volante redondo de ABS con control de temperatura. Distribuidor cerámico de 2 vías.
- Brazo a pared con rociador de ducha orientable: 242x242 mm.
- Soporte para ducha de mano con toma de agua a pared.
- Ducha de mano anticalcárea 120x120 mm. (3 tipos de chorro).
- Flexo metálico.

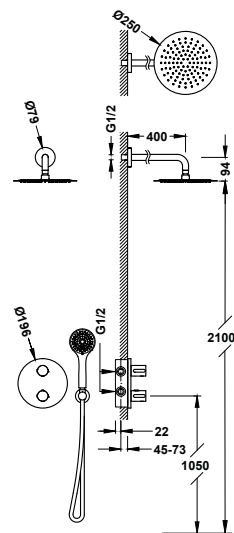

Kit de grifo termostático empotrado de 2 vías Therm-box para ducha

20425004

465,00

- Cuerpo empotrado incluido.
- Volante redondo de ABS con control de temperatura. Distribuidor cerámico de 2 vías.
- Brazo a pared con rociador de ducha orientable y de acero inoxidable: Ø 250 mm.
- Soporte para ducha de mano con toma de agua a pared.
- Ducha de mano anticalcárea: Ø 100 mm. (3 tipos de chorro).
- Flexo satinado.

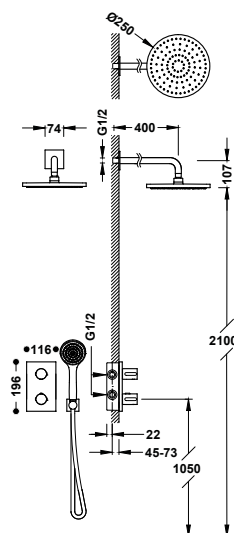

Kit de grifo termostático empotrado de 2 vías Therm-box para ducha

21625004

405,00

- Cuerpo empotrado incluido.
- Volante redondo de ABS con control de temperatura. Distribuidor cerámico de 2 vías.
- Brazo a pared con rociador de ducha orientable: Ø 250 mm.
- Soporte para ducha de mano con toma de agua a pared.
- Ducha de mano anticalcárea.
- Flexo metálico.



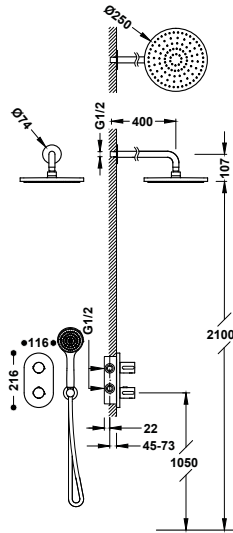

Kit de grifo termostático empotrado de 2 vías Therm-box para ducha

- Cuerpo empotrado incluido.
- Volante redondo de ABS con control de temperatura. Distribuidor cerámico de 2 vías.
- Brazo a pared con rociador de ducha orientable: Ø 250 mm.
- Soporte para ducha de mano con toma de agua a pared.
- Ducha de mano anticalcárea.
- Flexo metálico.

21525004 **455,00**

21525004NM **705,00**

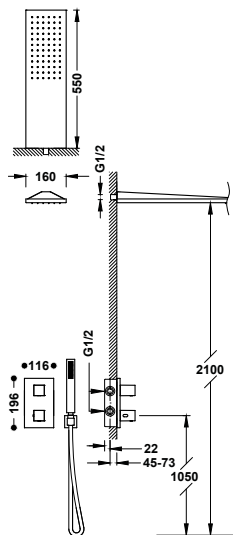
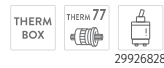

Kit de grifo termostático empotrado de 2 vías Therm-box para ducha

- Cuerpo empotrado incluido.
- Volante cuadrado con control de temperatura. Distribuidor cerámico de 2 vías.
- Rociador de ducha a pared de acero inoxidable: 160x550 mm.
- Soporte para ducha de mano con toma de agua a pared.
- Ducha de mano anticalcárea de latón.
- Flexo satinado.

20225055 **803,00**

20225055NM **1.245,00**

20225055BM **1.245,00**

20225055AC **1.245,00**

20225055OR **1.606,00**

20225055OM **1.606,00**

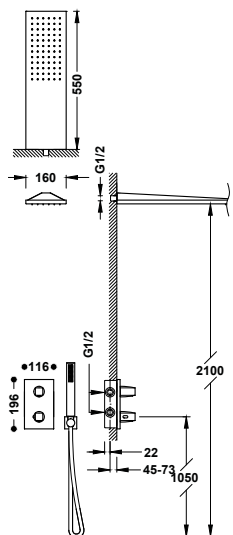

Kit de grifo termostático empotrado de 2 vías Therm-box para ducha

- Cuerpo empotrado incluido.
- Volante cuadrado-redondo con control de temperatura. Distribuidor cerámico de 2 vías.
- Rociador de ducha a pared de acero inoxidable: 160x550 mm.
- Soporte para ducha de mano con toma de agua a pared.
- Ducha de mano anticalcárea de latón.
- Flexo satinado.

21125005 **773,00**

21125005NM **1.198,00**

21125005BM **1.198,00**

21125005AC **1.198,00**

21125005KM **1.198,00**

21125005KMB **1.198,00**

21125005OR **1.546,00**

21125005OM **1.546,00**

21125005OP **1.546,00**

21125005OPM **1.546,00**



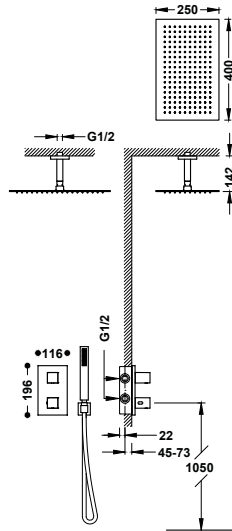

Kit de grifo termostático empotrado de 2 vías Therm-box para ducha

- Cuerpo empotrado incluido.
- Volante cuadrado con control de temperatura. Distribuidor cerámico de 2 vías.
- Brazo a techo con rociador de ducha orientable y de acero inoxidable: 400x250 mm.
- Soporte para ducha de mano con toma de agua a pared.
- Ducha de mano anticalcárea de latón.
- Flexo satinado.

	20225053	684,00
	20225053NM	1.060,00
	20225053BM	1.060,00
	20225053AC	1.060,00
	20225053OR	1.368,00
	20225053OM	1.368,00

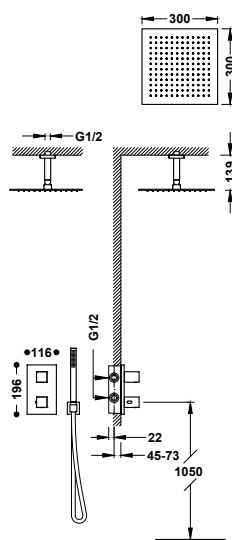

Kit de grifo termostático empotrado de 2 vías Therm-box para ducha

- Cuerpo empotrado incluido.
- Volante cuadrado con control de temperatura. Distribuidor cerámico de 2 vías.
- Brazo a techo con rociador de ducha orientable y de acero inoxidable: 300x300 mm.
- Soporte para ducha de mano con toma de agua a pared.
- Ducha de mano anticalcárea de latón.
- Flexo satinado.

	00625003	603,00
	00625003NM	935,00
	00625003BM	935,00
	00625003AC	935,00
	00625003OR	1.206,00
	00625003OM	1.206,00

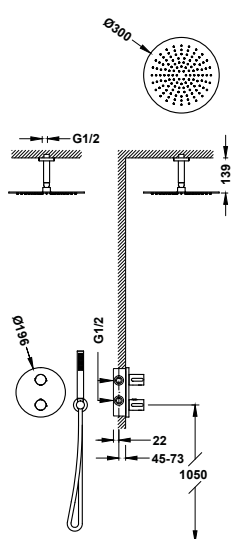

Kit de grifo termostático empotrado de 2 vías Therm-box para ducha

- Cuerpo empotrado incluido.
- Volante redondo con control de temperatura. Distribuidor cerámico de 2 vías.
- Brazo a techo con rociador de ducha orientable y de acero inoxidable: Ø 300 mm.
- Soporte para ducha de mano con toma de agua a pared.
- Ducha de mano anticalcárea de latón.
- Flexo satinado.



	26225003	546,00
	26225003NM	846,00
	26225003BM	846,00
	26225003AC	846,00
	26225003KM	846,00
	26225003KMB	846,00
	26225003OR	1.092,00
	26225003OM	1.092,00
	26225003OP	1.092,00
	26225003OPM	1.092,00

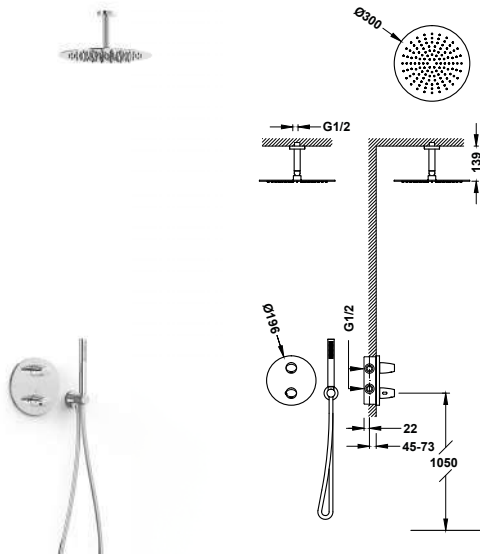



Kit de grifo termostático empotrado de 2 vías Therm-box para ducha





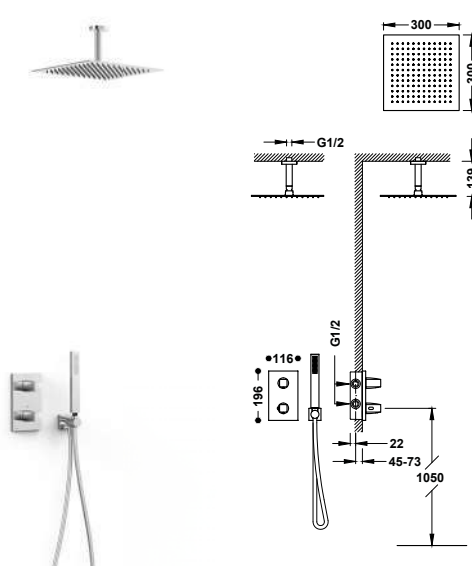





- Cuerpo empotrado incluido.
- Volante ovalado con control de temperatura. Distribuidor cerámico de 2 vías.
- Brazo a techo con rociador de ducha orientable y de acero inoxidable: Ø 300 mm.
- Soporte para ducha de mano con toma de agua a pared.
- Ducha de mano anticalcárea de latón.
- Flexo satinado.

	28125003	525,00
	28125003NM	814,00
	28125003AC	814,00



Kit de grifo termostático empotrado de 2 vías Therm-box para ducha

- Cuerpo empotrado incluido.
- Volante cuadrado-redondo con control de temperatura. Distribuidor cerámico de 2 vías.
- Brazo a techo con rociador de ducha orientable y de acero inoxidable: 300x300 mm.
- Soporte para ducha de mano con toma de agua a pared.
- Ducha de mano anticalcárea de latón.
- Flexo satinado.

	21125003	559,00
	21125003NM	866,00
	21125003BM	866,00
	21125003AC	866,00
	21125003KM	866,00
	21125003KMB	866,00
	21125003OR	1.118,00
	21125003OM	1.118,00
	21125003OP	1.118,00
	21125003OPM	1.118,00

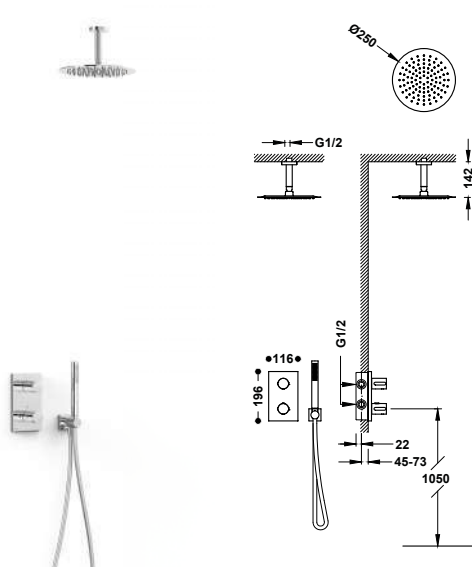

Kit de grifo termostático empotrado de 2 vías Therm-box para ducha

- Cuerpo empotrado incluido.
- Volante redondo con control de temperatura. Distribuidor cerámico de 2 vías.
- Brazo a techo con rociador de ducha orientable y de acero inoxidable: Ø 250 mm.
- Soporte para ducha de mano con toma de agua a pared.
- Ducha de mano anticalcárea de latón.
- Flexo satinado.

	06225003	483,00
---	----------	---------------



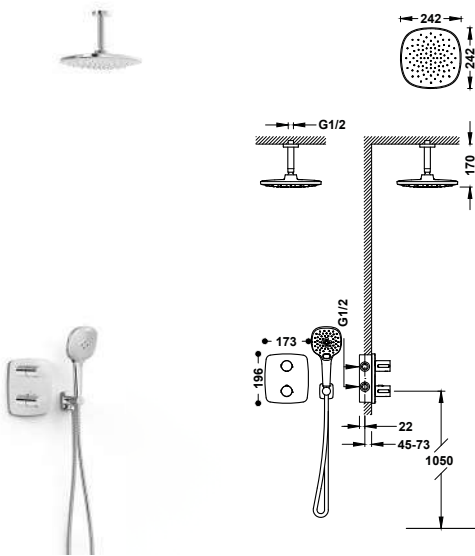

Kit de grifo termostático empotrado de 2 vías Therm-box para ducha

21725003

391,00

- Cuerpo empotrado incluido.
- Volante redondo de ABS con control de temperatura. Distribuidor cerámico de 2 vías.
- Brazo a techo con rociador de ducha orientable: 242x242 mm.
- Soporte para ducha de mano con toma de agua a pared.
- Ducha de mano anticalcárea 120x120 mm. (3 tipos de chorro).
- Flexo metálico.

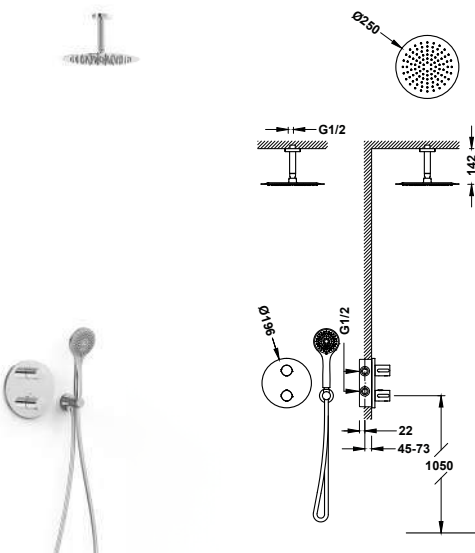

Kit de grifo termostático empotrado de 2 vías Therm-box para ducha

20425003

439,00

- Cuerpo empotrado incluido.
- Volante redondo de ABS con control de temperatura. Distribuidor cerámico de 2 vías.
- Brazo a techo con rociador de ducha orientable y de acero inoxidable: Ø 250 mm.
- Soporte para ducha de mano con toma de agua a pared.
- Ducha de mano anticalcárea: Ø 100 mm. (3 tipos de chorro).
- Flexo satinado.

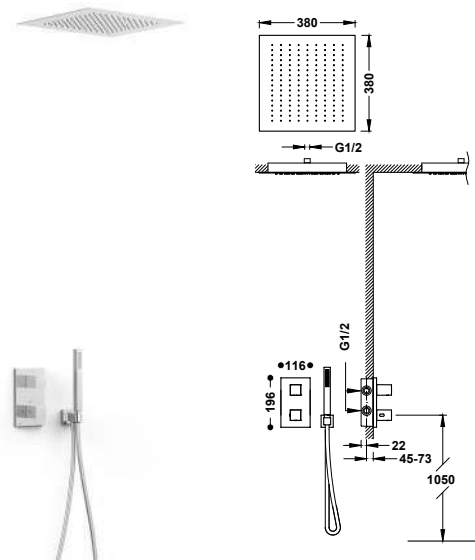

Kit de grifo termostático empotrado de 2 vías Therm-box para ducha

00625005

1.137,00

- Cuerpo empotrado incluido.
- Volante cuadrado con control de temperatura. Distribuidor cerámico de 2 vías.
- Rociador de ducha empotrado a techo de acero inoxidable: 380x380 mm.
- Soporte para ducha de mano con toma de agua a pared.
- Ducha de mano anticalcárea de latón.
- Flexo satinado.





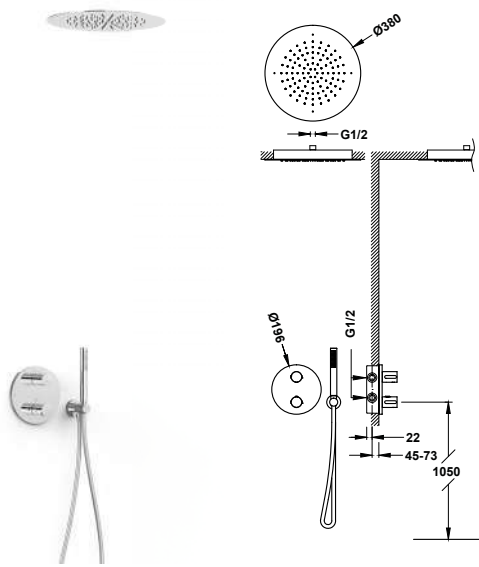





- 00625005NM 1.762,00
- 00625005BM 1.762,00
- 00625005AC 1.762,00
- 00625005OR 2.274,00
- 00625005OM 2.274,00





Kit de grifo termostático empotrado de 2 vías Therm-box para ducha

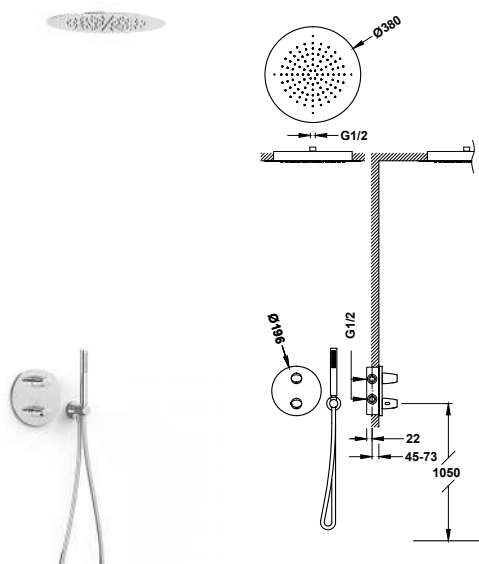

- Cuerpo empotrado incluido.
- Volante redondo con control de temperatura. Distribuidor cerámico de 2 vías.
- Rociador de ducha empotrado a techo de acero inoxidable: Ø 380 mm.
- Soporte para ducha de mano con toma de agua a pared.
- Ducha de mano anticalcárea de latón.
- Flexo satinado.

	26225005	1.122,00
	26225005NM	1.739,00
	26225005BM	1.739,00
	26225005AC	1.739,00
	26225005KM	1.739,00
	26225005KMB	1.739,00
	26225005OR	2.244,00
	26225005OM	2.244,00
	26225005OP	2.244,00
	26225005OPM	2.244,00



Kit de grifo termostático empotrado de 2 vías Therm-box para ducha

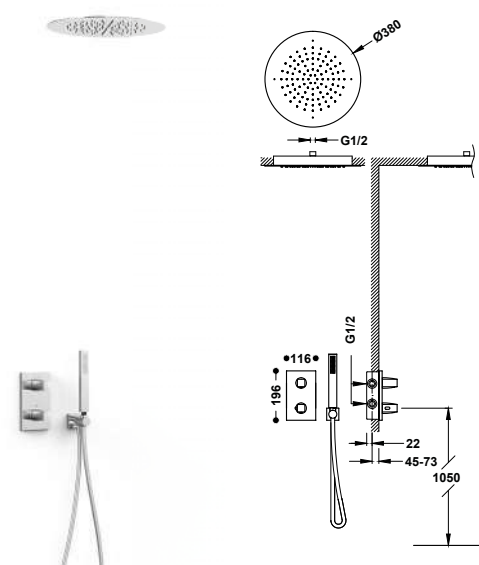

- Cuerpo empotrado incluido.
- Volante ovalado con control de temperatura. Distribuidor cerámico de 2 vías.
- Rociador de ducha empotrado a techo de acero inoxidable: Ø 380 mm.
- Soporte para ducha de mano con toma de agua a pared.
- Ducha de mano anticalcárea de latón.
- Flexo satinado.

	28125005	1.102,00
	28125005NM	1.708,00
	28125005AC	1.708,00



Kit de grifo termostático empotrado de 2 vías Therm-box para ducha

- Cuerpo empotrado incluido.
- Volante cuadrado-redondo con control de temperatura. Distribuidor cerámico de 2 vías.
- Rociador de ducha empotrado a techo de acero inoxidable: Ø 380 mm.
- Soporte para ducha de mano con toma de agua a pared.
- Ducha de mano anticalcárea de latón.
- Flexo satinado.

	21125006	1.110,00
	21125006NM	1.721,00
	21125006BM	1.721,00
	21125006AC	1.721,00
	21125006KM	1.721,00
	21125006KMB	1.721,00
	21125006OR	2.220,00
	21125006OM	2.220,00
	21125006OP	2.220,00
	21125006OPM	2.220,00



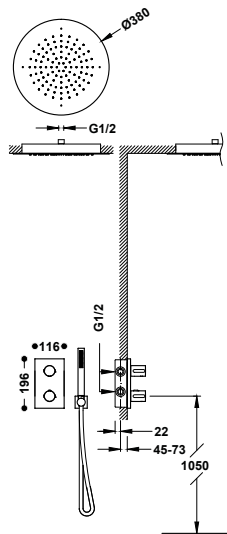

Kit de grifo termostático empotrado de 2 vías Therm-box para ducha

06225005

1.102,00

- Cuerpo empotrado incluido.
- Volante redondo con control de temperatura. Distribuidor cerámico de 2 vías.
- Rociador empotrado a techo de acero inoxidable: Ø 380 mm.
- Soporte para ducha de mano con toma de agua a pared.
- Ducha de mano anticalcárea de latón.
- Flexo satinado.

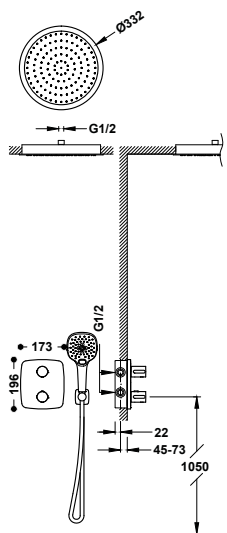

Kit de grifo termostático empotrado de 2 vías Therm-box para ducha

21725005

790,00

- Cuerpo empotrado incluido.
- Volante redondo de ABS con control de temperatura. Distribuidor cerámico de 2 vías.
- Rociador empotrado a techo de latón: Ø 332 mm.
- Soporte para ducha de mano con toma de agua a pared.
- Ducha de mano anticalcárea 120x120 mm. (3 tipos de chorro).
- Flexo metálico.

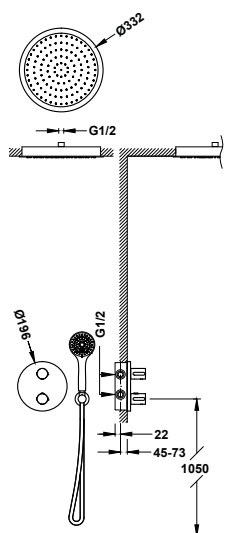

Kit de grifo termostático empotrado de 2 vías Therm-box para ducha

20425005

792,00

- Cuerpo empotrado incluido.
- Volante redondo de ABS con control de temperatura. Distribuidor cerámico de 2 vías.
- Rociador empotrado a techo de latón: Ø 332 mm.
- Soporte para ducha de mano con toma de agua a pared.
- Ducha de mano anticalcárea: Ø 100 mm. (3 tipos de chorro).
- Flexo satinado.

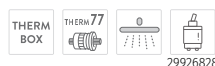

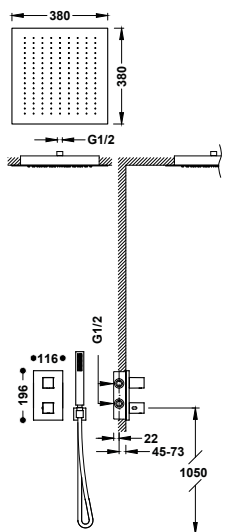

Kit de grifo termostático empotrado de 2 vías Therm-box para ducha

- Cuerpo empotrado incluido.
- Volante cuadrado con control de temperatura. Distribuidor cerámico de 2 vías.
- Rociador de ducha empotrado a techo de acero inoxidable: 380x380 mm.
- Soporte para ducha de mano con toma de agua a pared.
- Ducha de mano anticalcárea de latón.
- Flexo satinado.

	20225056	1.140,00
	20225056NM	1.767,00
	20225056BM	1.767,00
	20225056AC	1.767,00
	20225056OR	2.280,00
	20225056OM	2.280,00



Kit de grifo termostático empotrado de 2 vías Therm-box para bañera y ducha

- Cuerpo empotrado incluido.
- Volante cuadrado con control de temperatura. Distribuidor cerámico de 2 vías.
- Caño fijo de bañera a pared.
- Soporte para ducha de mano con toma de agua a pared.
- Ducha de mano anticalcárea de latón.
- Flexo satinado.

	00625006	529,00
	00625006NM	820,00
	00625006BM	820,00
	00625006AC	820,00
	00625006OR	1.058,00
	00625006OM	1.058,00

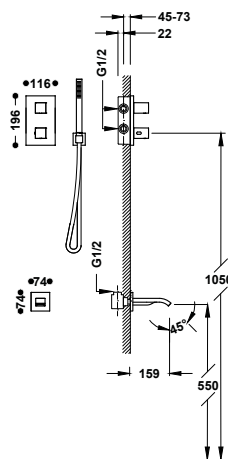

Kit de grifo termostático empotrado de 2 vías Therm-box para bañera y ducha

- Cuerpo empotrado incluido.
- Volante redondo con control de temperatura. Distribuidor cerámico de 2 vías.
- Caño fijo de bañera a pared.
- Soporte para ducha de mano con toma de agua a pared.
- Ducha de mano anticalcárea de latón.
- Flexo satinado.

	26225006	461,00
	26225006NM	715,00
	26225006BM	715,00
	26225006AC	715,00
	26225006KM	715,00
	26225006KMB	715,00
	26225006OR	922,00
	26225006OM	922,00
	26225006OP	922,00
	26225006OPM	922,00

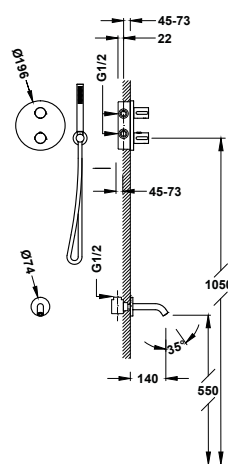

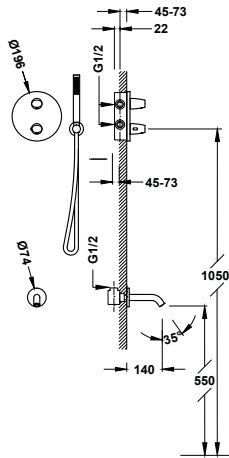

Kit de grifo termostático empotrado de 2 vías Therm-box para bañera y ducha

- Cuerpo empotrado incluido.
- Volante ovalado con control de temperatura. Distribuidor cerámico de 2 vías.
- Caño fijo de bañera a pared.
- Soporte para ducha de mano con toma de agua a pared.
- Ducha de mano anticalcárea de latón.
- Flexo satinado.

	28125006	441,00
	28125006NM	684,00
	28125006AC	684,00

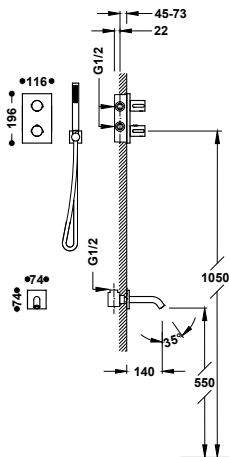

Kit de grifo termostático empotrado de 2 vías Therm-box para bañera y ducha

- Cuerpo empotrado incluido.
- Volante redondo con control de temperatura. Distribuidor cerámico de 2 vías.
- Caño fijo de bañera a pared.
- Soporte para ducha de mano con toma de agua a pared.
- Ducha de mano anticalcárea de latón.
- Flexo satinado.

	06225006	441,00
---	----------	---------------

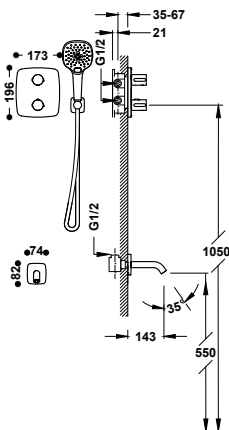

Kit de grifo termostático empotrado de 2 vías Therm-box para bañera y ducha

- Cuerpo empotrado incluido.
- Volante redondo de ABS con control de temperatura. Distribuidor cerámico de 2 vías.
- Caño fijo de bañera a pared.
- Soporte para ducha de mano con toma de agua a pared.
- Ducha de mano anticalcárea 120x120 mm. (3 tipos de chorro).
- Flexo metálico.

	21725006	401,00
---	----------	---------------



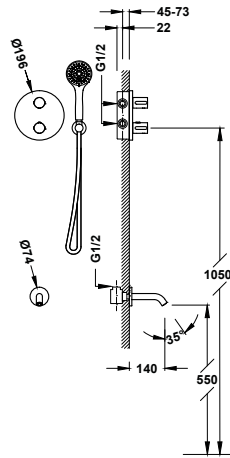

Kit de grifo termostático empotrado de 2 vías Therm-box para bañera y ducha

20425006

393,00

- Cuerpo empotrado incluido.
- Volante redondo de ABS con control de temperatura. Distribuidor cerámico de 2 vías.
- Caño fijo de bañera a pared.
- Soporte para ducha de mano con toma de agua a pared.
- Ducha de mano anticalcárea: Ø 100 mm. (3 tipos de chorro).
- Flexo satinado.

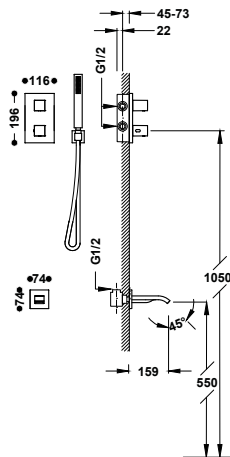
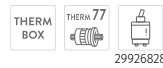

Kit de grifo termostático empotrado de 2 vías Therm-box para bañera y ducha

20225057

532,00

- Cuerpo empotrado incluido.
- Volante cuadrado con control de temperatura. Distribuidor cerámico de 2 vías.
- Caño fijo de bañera a pared.
- Soporte para ducha de mano con toma de agua a pared.
- Ducha de mano anticalcárea de latón.
- Flexo satinado.

- 20225057NM **825,00**
- 20225057BM **825,00**
- 20225057AC **825,00**
- 20225057OR **1.064,00**
- 20225057OM **1.064,00**

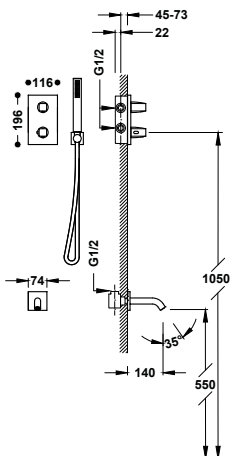

Kit de grifo termostático empotrado de 2 vías Therm-box para bañera y ducha

21125007

449,00

- Cuerpo empotrado incluido.
- Volante cuadrado-redondo con control de temperatura. Distribuidor cerámico de 2 vías.
- Caño fijo de bañera a pared.
- Soporte para ducha de mano con toma de agua a pared.
- Ducha de mano anticalcárea de latón.
- Flexo satinado.

- 21125007NM **696,00**
- 21125007BM **696,00**
- 21125007AC **696,00**
- 21125007KM **696,00**
- 21125007KMB **696,00**
- 21125007OR **898,00**
- 21125007OM **898,00**
- 21125007OP **898,00**
- 21125007OPM **898,00**







OVER-WALL





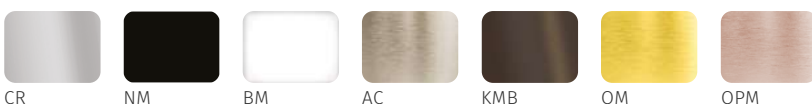

















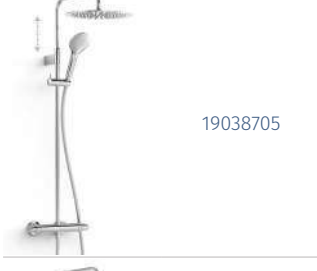









La colección de termostáticas Over-wall agrupa todos los grifos termostáticos murales de Tres. Con diseños distintos que se adaptan a todos los ambientes, consiguen un control preciso de la temperatura y todas las prestaciones para una ducha agradable. Los conjuntos termostáticos Over-wall son la solución para actualizar tu ducha sin grandes reformas y con la mejor tecnología.

Acabados disponibles:



























OVER-WALL

Referencia	Página	Acabados disponibles			Flexo	Rociador	Material de fabricación	Caudal (l/min)	Ducha de mano	Material de fabricación	Número de funciones	Caudal (l/min)
 19039306	284		✓		 1,5 m	300x200		12	-		1	9,5
 19039305	285		✓		 1,5 m	Ø300		12	-		1	9,5
 19038705	285		✓	✓	 1,5 m	Ø300		12	Ø110		3	8,5 2 8,5
 19038702	285		✓	✓	 1,5 m	300x300		12	96x110		3	8,5 2 8,5
 19039302	286		✓	✓	 1,5 m	Ø300		12	-		1	9,5
 19039307	286		✓	✓	 1,5 m	300x300		12	-		1	9,5



Referencia	Página	Acabados disponibles			Flexo	Rociador	Material de fabricación	Caudal (l/min)	Ducha de mano	Material de fabricación	Número de funciones	Caudal (l/min)
 19039301	286				 1,7 - 2 m	Ø250		12	Ø100		1	16
 19038701	287			✓	 1,5 m	Ø300		12	Ø100		1	16
 19038501	287				 1,7 - 2 m	Ø250		12	Ø100		1	16
 19019601	287				 1,7 - 2 m				Ø100		3	14 14 10
 21619601	288				 1,7 - 2 m				Ø100		1	16
 19031202 19031205	289		✓	✓	 1,7 m	Ø300 300x300		12	-		1	9,5

DESIGNED BY YOU

Tu grifo termostático Over-wall diseñado por ti y para ti. Un grifo personalizado para crear tu ducha perfecta.

Entra en la web para configurar tu grifo Over-wall

Pasos para configurar tu conjunto Over-wall

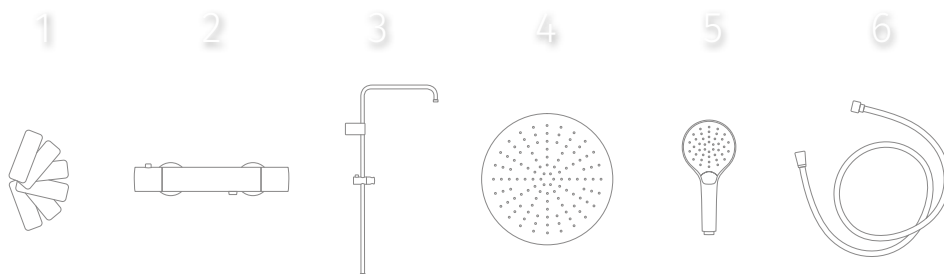

1 ACABADO

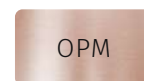
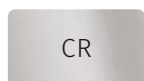

2 GRIFO TERMOSTÁTICO (PÁGINA 278)



19016906



19016905 19016904 19016903 19016902

3 BARRA DE DUCHA (PÁGINA 279)



03463502 03463501 03464501 03463506 03463505



03463502 03463501 03464501

4 ROCIADOR (PÁGINA 372)

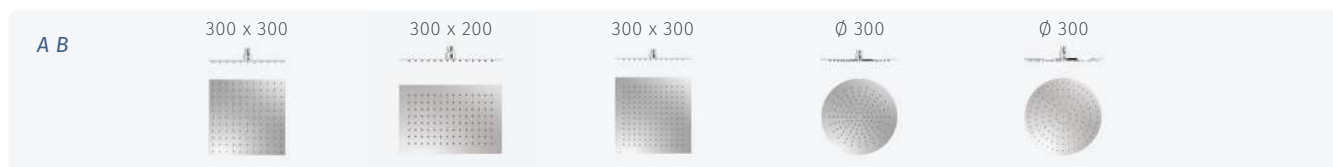

13413830 134315007 134315012 134315010 13413730

5 DUCHA DE MANO (PÁGINA 381)

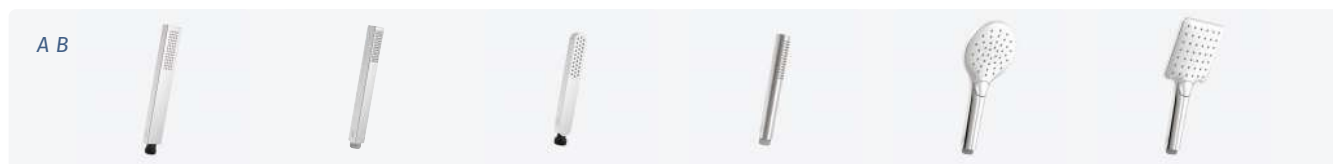

20263901 00663901 03463901 03411601 29963112 29963113

6 FLEJO (PÁGINA 387)

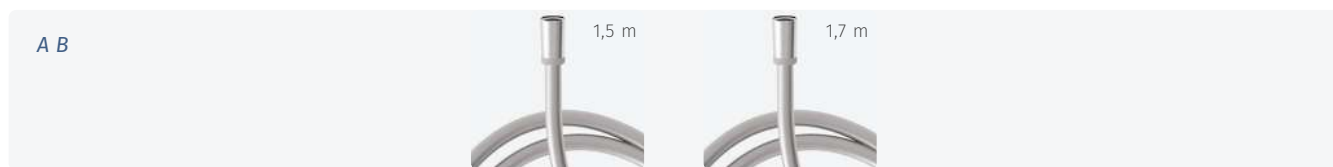

913460915 9134609

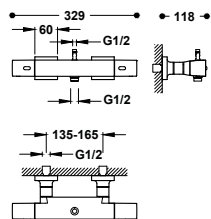

Grifo termostático mural de 2 vías Over-wall con conexión para barra de ducha

A completar con el resto de elementos de ducha. Inversor integrado en el regulador de caudal. Volante cuadrado.



29916836XX

	19016906	270,00
	19016906NM	419,00
	19016906BM	419,00
	19016906AC	419,00
	19016906OM	540,00

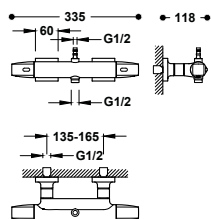

Grifo termostático mural de 2 vías Over-wall con conexión para barra de ducha

A completar con el resto de elementos de ducha. Inversor integrado en el regulador de caudal. Volante cuadrado-redondo.



29916835XX

	19016905	220,00
	19016905NM	341,00
	19016905BM	341,00
	19016905AC	341,00
	19016905KMB	341,00
	19016905OM	440,00
	19016905OPM	440,00

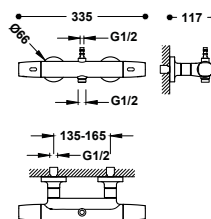

Grifo termostático mural de 2 vías Over-wall con conexión para barra de ducha

A completar con el resto de elementos de ducha. Inversor integrado en el regulador de caudal. Volante con bordes redondeados.



29916834XX

	19016904	220,00
	19016904NM	341,00
	19016904BM	341,00
	19016904AC	341,00
	19016904KMB	341,00
	19016904OM	440,00
	19016904OPM	440,00

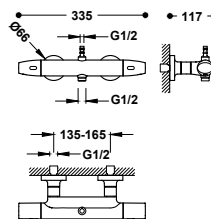

Grifo termostático mural de 2 vías Over-wall con conexión para barra de ducha

A completar con el resto de elementos de ducha. Inversor integrado en el regulador de caudal. Volante ovalado.



29916833XX

	19016903	220,00
	19016903NM	341,00
	19016903BM	341,00
	19016903AC	341,00
	19016903KMB	341,00
	19016903OM	440,00
	19016903OPM	440,00

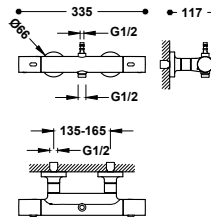

Grifo termostático mural de 2 vías Over-wall con conexión para barra de ducha

A completar con el resto de elementos de ducha. Inversor integrado en el regulador de caudal. Volante redondo.



29916832XX

	19016902	220,00
	19016902NM	341,00
	19016902BM	341,00
	19016902AC	341,00
	19016902KMB	341,00
	19016902OM	440,00
	19016902OPM	440,00



Grifo termostático mural de 2 vías Over-wall con conexión para barra de ducha

A completar con el resto de elementos de ducha. Inversor integrado en el regulador de caudal. Volante redondo de ABS.

19016901 170,00

19016901NM 264,00

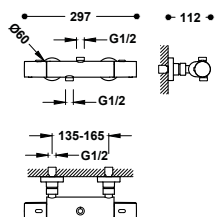

Barra de ducha adaptable a grifo termostático mural con conexión compatible

A completar con el resto de elementos de ducha.

03463502 100,00

03463502NM 155,00

03463502BM 155,00

03463502AC 155,00

03463502KMB 155,00

03463502OM 200,00

03463502OPM 200,00

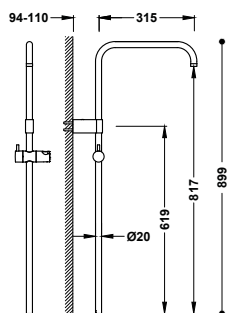

Barra de ducha larga adaptable a grifo termostático mural con conexión compatible

A completar con el resto de elementos de ducha.

03463501 110,00

03463501NM 171,00

03463501BM 171,00

03463501AC 171,00

03463501KMB 171,00

03463501OM 220,00



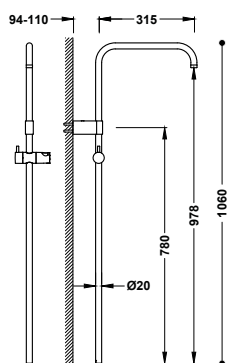

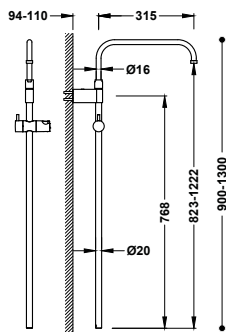

03463501OPM 220,00





Barra de ducha telescópica adaptable a grifo termostático mural con conexión compatible





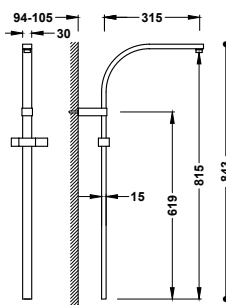

A completar con el resto de elementos de ducha.

	03464501	140,00
	03464501NM	217,00
	03464501BM	217,00
	03464501AC	217,00
	03464501KMB	217,00
	03464501OM	280,00
	03464501OPM	280,00



Barra de ducha adaptable a grifo termostático mural con conexión compatible





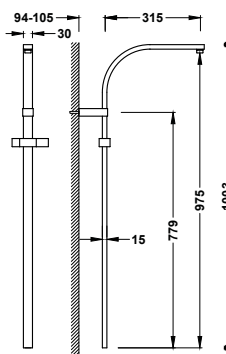

A completar con el resto de elementos de ducha.

	03463506	140,00
	03463506NM	217,00
	03463506BM	217,00
	03463506AC	217,00
	03463506KMB	217,00
	03463506OM	280,00
	03463506OPM	280,00



Barra de ducha larga adaptable a grifo termostático mural con conexión compatible

A completar con el resto de elementos de ducha.

	03463505	150,00
	03463505NM	233,00
	03463505BM	233,00
	03463505AC	233,00
	03463505KMB	233,00
	03463505OM	300,00
	03463505OPM	300,00

GRIFOS TERMOSTÁTICOS PARA DUCHA

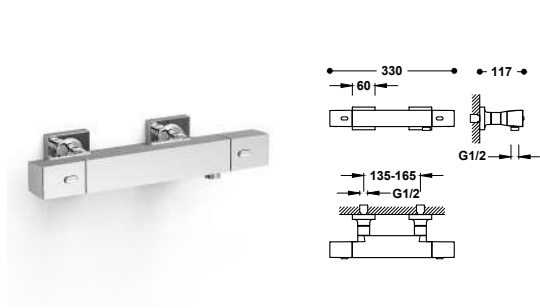

Grifo termostático mural Over-wall para ducha
Sin complementos. Volante cuadrado.

- 19016406 **220,00**
- 19016406NM **341,00**
- 19016406BM **341,00**
- 19016406AC **341,00**
- 19016406OM **440,00**



29916836XX

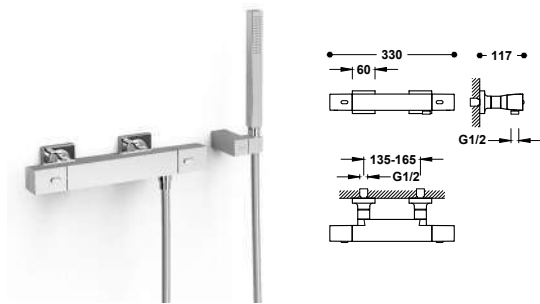

Grifo termostático mural Over-wall para ducha
Ducha de mano anticalcárea de latón. Soporte orientable para ducha de mano. Flexo satinado. Volante cuadrado.

- 19016469 **265,00**
- 19016469NM **411,00**
- 19016469BM **411,00**
- 19016469AC **411,00**
- 19016469OM **530,00**



29916836XX

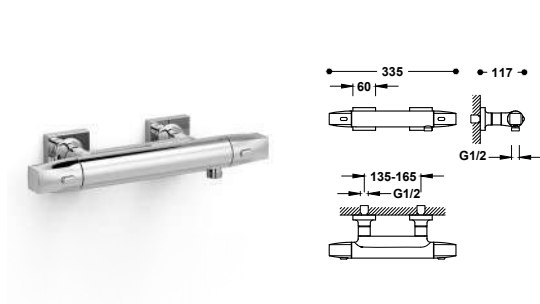

Grifo termostático mural Over-wall para ducha
Sin complementos. Volante cuadrado-redondo.

- 19016405 **180,00**
- 19016405NM **279,00**
- 19016405BM **279,00**
- 19016405AC **279,00**
- 19016405KMB **279,00**
- 19016405OM **360,00**
- 19016405OPM **360,00**



29916835XX

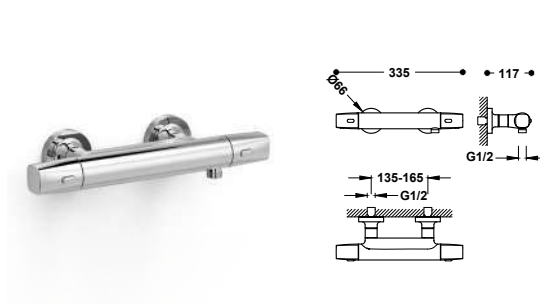

Grifo termostático mural Over-wall para ducha
Sin complementos. Volante con bordes redondeados.

- 19016404 **180,00**
- 19016404NM **279,00**
- 19016404BM **279,00**
- 19016404AC **279,00**
- 19016404KMB **279,00**
- 19016404OM **360,00**
- 19016404OPM **360,00**



29916834XX

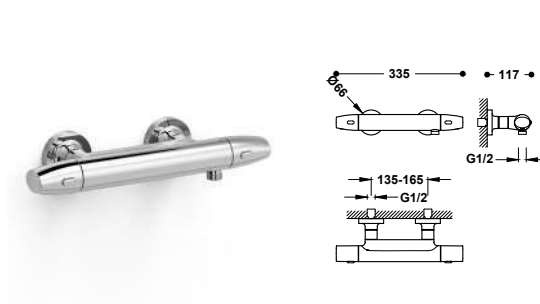

Grifo termostático mural Over-wall para ducha
Sin complementos. Volante ovalado.

- 19016403 **180,00**
- 19016403NM **279,00**
- 19016403BM **279,00**
- 19016403AC **279,00**
- 19016403KMB **279,00**
- 19016403OM **360,00**
- 19016403OPM **360,00**



29916833XX



Grifo termostático mural Over-wall para ducha
Sin complementos. Volante redondo.

	19016402	180,00
	19016402NM	279,00
	19016402BM	279,00
	19016402AC	279,00
	19016402KMB	279,00
	19016402OM	360,00
	19016402OPM	360,00

OVER WALL     
29916832XX





Grifo termostático mural Over-wall para ducha
Ducha de mano anticalcárea de latón. Soporte orientable para ducha de mano. Flexo satinado. Volante redondo.



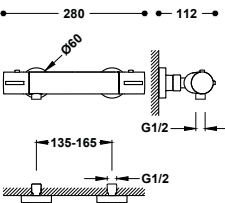



	19016429	225,00
	19016429NM	349,00
	19016429BM	349,00
	19016429AC	349,00
	19016429KMB	349,00
	19016429OM	450,00
	19016429OPM	450,00

OVER WALL     
29916832XX

Grifo termostático mural para ducha
Sin complementos. Volante redondo de ABS.



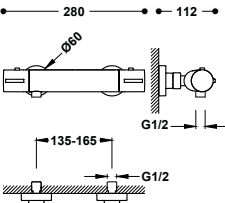

	21716401	140,00
---	----------	---------------

      
29916803 IA

Grifo termostático mural para ducha
Ducha de mano anticalcárea 120x120 mm. (3 tipos de chorro). Soporte orientable para ducha de mano. Flexo metálico. Volante redondo de ABS.

	21716409	185,00
---	----------	---------------

   
29916803



Grifo termostático mural Over-wall para ducha
Sin complementos. Volante redondo de ABS.

	19016401	135,00
	19016401NM	209,00

OVER WALL    
29916831XX

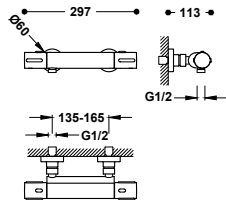

Grifo termostático mural Over-wall para ducha

Ducha de mano anticalcárea: Ø 100 mm. Soporte orientable para ducha de mano. Flexo metálico. Volante redondo de ABS.

19016419 **180,00**

19016419NM **279,00**



GRIFOS TERMOSTÁTICOS PARA BAÑERA

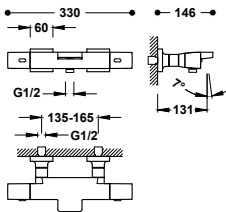

Grifo termostático mural Over-wall para bañera y ducha

Sin complementos. Inversor integrado en el regulador de caudal. Volante cuadrado.

19017406 **310,00**

19017406NM **481,00**

19017406AC **481,00**

19017406BM **481,00**

19017406OM **620,00**

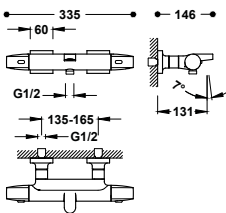

Grifo termostático mural Over-wall para bañera y ducha

Sin complementos. Inversor integrado en el regulador de caudal. Volante cuadrado-redondo.

19017405 **260,00**

19017405NM **403,00**

19017405BM **403,00**

19017405AC **403,00**

19017405KMB **403,00**

19017405OM **520,00**

19017405OPM **520,00**

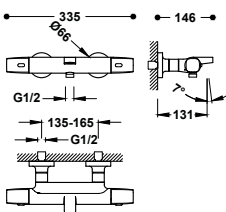

Grifo termostático mural Over-wall para bañera y ducha

Sin complementos. Inversor integrado en el regulador de caudal. Volante con bordes redondeados.

19017404 **260,00**

19017404NM **403,00**

19017404BM **403,00**

19017404AC **403,00**

19017404KMB **403,00**

19017404OM **520,00**

19017404OPM **520,00**

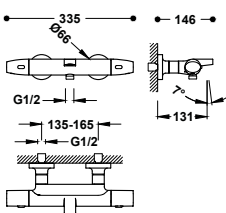

Grifo termostático mural Over-wall para bañera y ducha

Sin complementos. Inversor integrado en el regulador de caudal. Volante ovalado.

19017403 **260,00**

19017403NM **403,00**

19017403BM **403,00**

19017403AC **403,00**

19017403KMB **403,00**

19017403OM **520,00**

19017403OPM **520,00**



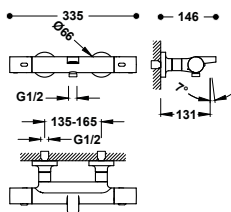

Grifo termostático mural Over-wall para bañera y ducha
Sin complementos. Inversor integrado en el regulador de caudal. Volante redondo.

	19017402	260,00
	19017402NM	403,00
	19017402BM	403,00
	19017402AC	403,00
	19017402KMB	403,00
	19017402OM	520,00
	19017402OPM	520,00

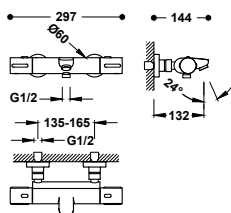

Grifo termostático mural Over-wall para bañera y ducha
Sin complementos. Inversor integrado en el regulador de caudal. Volante redondo de ABS.

	19017401	200,00
	19017401NM	310,00



CONJUNTOS TERMOSTÁTICOS PARA DUCHA

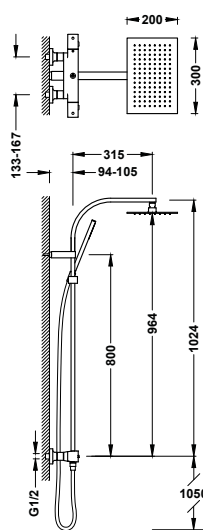

Conjunto de grifo termostático mural Over-wall de 2 vías para ducha

- Con inversor integrado en el regulador de caudal.
- Volante cuadrado.
- Rociador de ducha orientable de acero inoxidable: 300x200 mm.
- Soporte deslizante y orientable para ducha de mano.
- Ducha de mano anticalcárea de latón.
- Flexo satinado.

	19039306	691,00
	19039306NM	1.071,00
	19039306BM	1.071,00
	19039306AC	1.071,00
	19039306OM	1.382,00



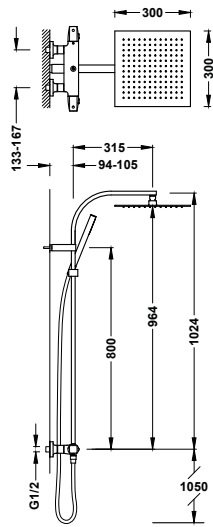

Conjunto de grifo termostático mural Over-wall de 2 vías para ducha

- Con inversor integrado en el regulador de caudal.
- Volante cuadrado-redondo.
- Rociador de ducha orientable de acero inoxidable: 300x300 mm.
- Soporte deslizante y orientable para ducha de mano.
- Ducha de mano anticalcárea de latón.
- Flexo satinado.

	19039305	595,00
	19039305NM	922,00
	19039305BM	922,00
	19039305AC	922,00
	19039305KMB	922,00
	19039305OM	1.190,00
	19039305OPM	1.190,00



29916835XX

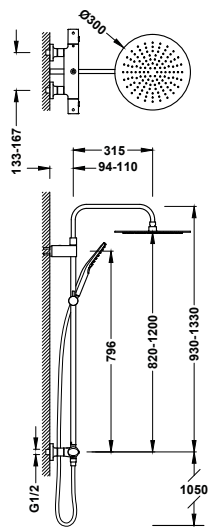

Conjunto de grifo termostático mural Over-wall de 2 vías para ducha

- Con inversor integrado en el regulador de caudal.
- Volante ovalado.
- Barra de ducha telescópica.
- Rociador de ducha orientable de acero inoxidable: Ø 300 mm.
- Soporte deslizante y orientable para ducha de mano.
- Ducha de mano anticalcárea: Ø 110 mm. (3 tipos de chorro).
- Flexo satinado.

	19038705	563,00
	19038705NM	873,00
	19038705BM	873,00
	19038705AC	873,00
	19038705KMB	873,00
	19038705OM	1.126,00
	19038705OPM	1.126,00



29916833XX

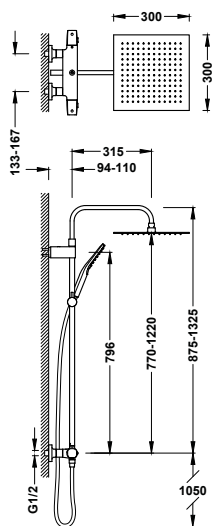

Conjunto de grifo termostático mural Over-wall de 2 vías para ducha

- Con inversor integrado en el regulador de caudal.
- Volante con bordes redondeados.
- Barra de ducha telescópica.
- Rociador de ducha orientable de acero inoxidable: 300x300 mm.
- Soporte deslizante y orientable para ducha de mano.
- Ducha de mano anticalcárea: 96x110 mm. (3 tipos de chorro).
- Flexo satinado.

	19038702	592,00
	19038702NM	918,00
	19038702BM	918,00
	19038702AC	918,00
	19038702KMB	918,00
	19038702OM	1.184,00
	19038702OPM	1.184,00



29916834XX

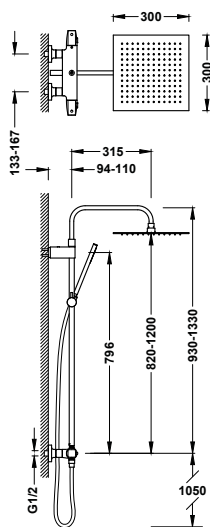

Conjunto de grifo termostático mural Over-wall de 2 vías para ducha

- Con inversor integrado en el regulador de caudal.
- Volante cuadrado-redondo.
- Barra de ducha telescópica.
- Rociador de ducha orientable de acero inoxidable: 300x300 mm.
- Soporte deslizante y orientable para ducha de mano.
- Ducha de mano anticalcárea de latón.
- Flexo satinado.

	19039307	598,00
	19039307NM	927,00
	19039307BM	927,00
	19039307AC	927,00
	19039307KMB	927,00
	19039307OM	1.196,00
	19039307OPM	1.196,00



29916835XX

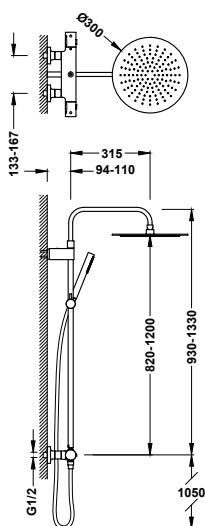

Conjunto de grifo termostático mural Over-wall de 2 vías para ducha

- Con inversor integrado en el regulador de caudal.
- Volante redondo.
- Barra de ducha telescópica.
- Rociador de ducha orientable de acero inoxidable: Ø 300 mm.
- Soporte deslizante y orientable para ducha de mano.
- Ducha de mano anticalcárea de latón.
- Flexo satinado.

	19039302	563,00
	19039302NM	873,00
	19039302BM	873,00
	19039302AC	873,00
	19039302KMB	873,00
	19039302OM	1.126,00
	19039302OPM	1.126,00



29916832XX

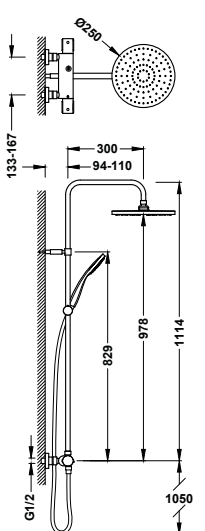

Conjunto de grifo termostático mural Over-wall de 2 vías para ducha

- Con inversor integrado en el regulador de caudal.
- Volante redondo de ABS.
- Rociador de ducha orientable: Ø 250 mm.
- Soporte deslizante y orientable para ducha de mano.
- Ducha de mano anticalcárea: Ø 100 mm.
- Flexo metálico.

	19039301	411,00
	19039301NM	637,00



29916831XX

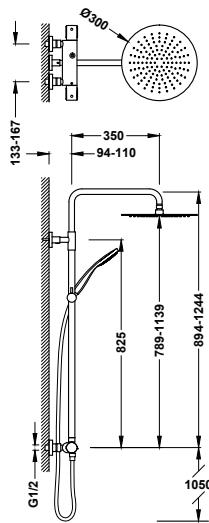

Conjunto de grifo termostático mural Over-wall de 2 vías para ducha

- Con inversor integrado en el regulador de caudal.
- Volante redondo de ABS.
- Barra de ducha telescópica.
- Rociador de ducha orientable de acero inoxidable: Ø 300 mm.
- Soporte deslizante y orientable para ducha de mano.
- Ducha de mano anticalcárea.
- Flexo metálico.

19038701 **483,00**

19038701NM **749,00**

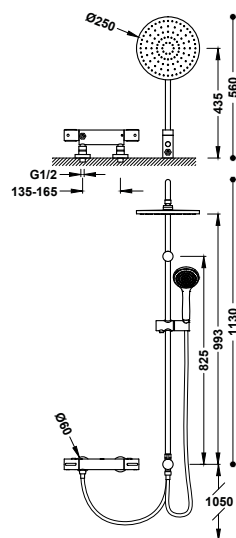

Conjunto de grifo termostático mural Over-wall de 2 vías para ducha

- Con inversor integrado en la barra de ducha.
- Volante redondo de ABS.
- Rociador de ducha orientable: Ø 250 mm.
- Soporte deslizante y orientable para ducha de mano.
- Ducha de mano anticalcárea: Ø 100 mm.
- Flexo metálico.

19038501 **368,00**

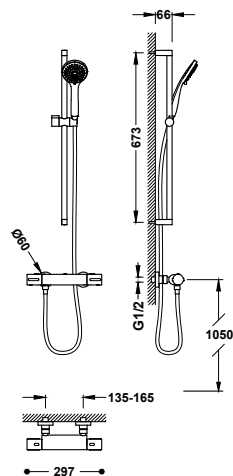

Kit de grifo termostático mural Over-wall para ducha

- Volante redondo de ABS.
- Barra de ducha: long. 673 mm y Ø 20,6 mm.
- Soporte deslizante y orientable para ducha de mano.
- Ducha de mano anticalcárea: Ø 100 mm. (3 tipos de chorro).
- Flexo metálico.

19019601 **197,00**



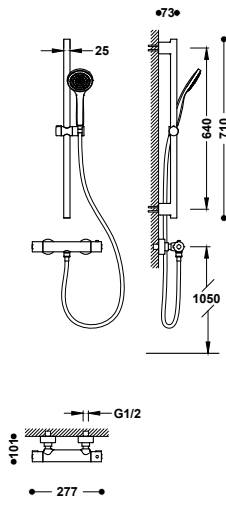

Kit de grifo termostático mural para ducha

- Barra de ducha: long. 640 mm.
- Soporte deslizante y orientable para ducha de mano.
- Ducha de mano anticalcárea: Ø 100 mm.
- Flexo metálico.

■ 21619601 **244,00**

■ 21619601NM **378,00**

CONJUNTOS TERMOSTÁTICOS PARA BAÑERA

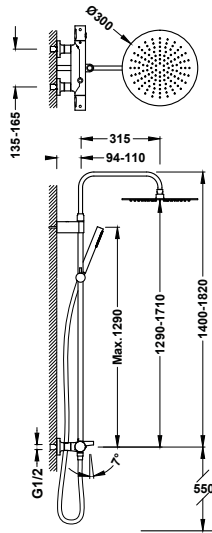

Conjunto de grifo termostático mural Over-wall de 3 vías para bañera y ducha

- Con inversor integrado en el regulador de caudal.
- Volante redondo.
- Barra de ducha telescópica.
- Rociador de ducha orientable de acero inoxidable: Ø 300 mm.
- Soporte deslizante y orientable para ducha de mano.
- Ducha de mano anticalcárea de latón.
- Flexo satinado.

	19031202	603,00
	19031202NM	935,00
	19031202BM	935,00
	19031202AC	935,00
	19031202KMB	935,00
	19031202OM	1.206,00
	19031202OPM	1.206,00



29916832XX

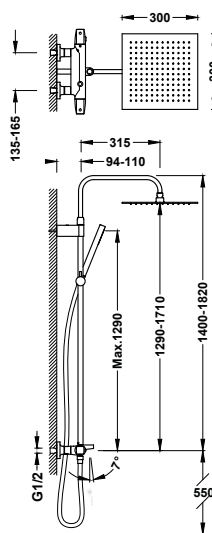

Conjunto de grifo termostático mural Over-wall de 3 vías para bañera y ducha

- Con inversor integrado en el regulador de caudal.
- Volante cuadrado-redondo.
- Barra de ducha telescópica.
- Rociador de ducha orientable de acero inoxidable: 300x300 mm.
- Soporte deslizante y orientable para ducha de mano.
- Ducha de mano anticalcárea de latón.
- Flexo satinado.

	19031205	635,00
	19031205NM	984,00
	19031205BM	984,00
	19031205AC	984,00
	19031205KMB	984,00
	19031205OM	1.270,00
	19031205OPM	1.270,00



29916835XX

3V

Más funciones con la misma facilidad de uso. Los monomandos se caracterizan por su funcionalidad. Esta gama empotrada de monomandos no renuncia a ello y añade belleza y simplicidad en su diseño con la gran ventaja de ofrecer 3 vías distintas de salida del agua.

Acabados disponibles:

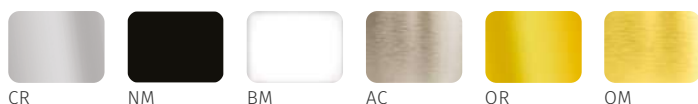

CR

NM

BM

AC

OR

OM





3V

Más funciones con la misma facilidad de uso



- Un único mando abre y cierra el paso del agua, ajusta la temperatura y regula el caudal.
- Un selector de funciones te permite elegir cualquiera de las tres posibles salidas del agua.
- El control y el soporte de ducha suministrados en los kits están integrados en un solo cuerpo empotrado no divisible.

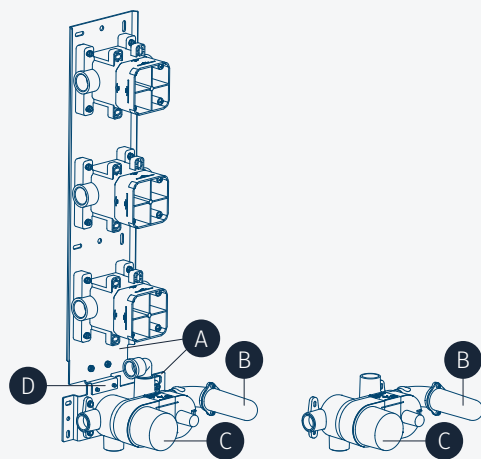

- Ⓐ Perfil de instalación a muro o pladur nivelable.
- Ⓑ Soporte con toma de ducha integrado y protector estanco.
- Ⓒ Protector extraíble. Corte exterior para proteger las partes cromadas.
- Ⓓ Alineación perfecta gracias al anclaje entre cuerpo central y jets mediante perfiles.

GRIFO MONOMANDO DE 3 VÍAS

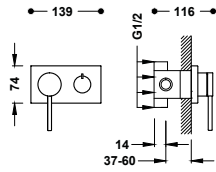

Grifo monomando empotrado de 3 vías para ducha
Con cierre y regulación de caudal. Cuerpo empotrado incluido.



	21027399	395,00
	21027399NM	612,00
	21027399BM	612,00
	21027399AC	612,00
	21027399OR	790,00
	21027399OM	790,00

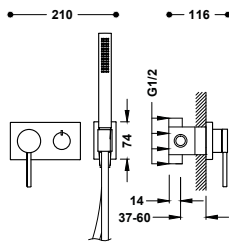

Grifo monomando empotrado de 3 vías para ducha
· Con cierre y regulación de caudal.
· Cuerpo empotrado incluido.
· Ducha móvil anticalcárea de latón.
· Soporte con toma de agua a pared.
· Flexo satinado.



	21027391	528,00
	21027391NM	818,00
	21027391BM	818,00
	21027391AC	818,00
	21027391OR	1.056,00
	21027391OM	1.056,00

Soporte fijo con toma de agua para ducha de mano y flexo
Con toma de agua a pared. Válvula antirretorno. Material: Latón.

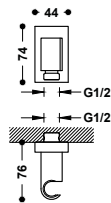

	20718201	70,00
	20718201NM	109,00
	20718201BM	109,00
	20718201AC	109,00
	20718201OR	140,00
	20718201OM	140,00

KITS DE 3 VÍAS

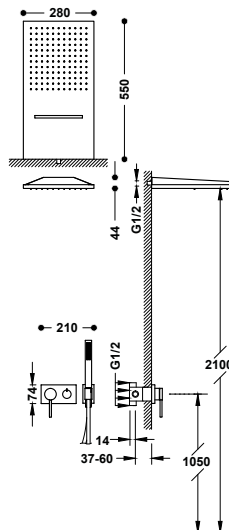

Kit de grifo monomando empotrado de 3 vías para ducha
· Con cierre y regulación de caudal.
· Cuerpo empotrado incluido.
· Rociador de ducha a pared de acero inoxidable con 2 tipos de chorro (lluvia/cascada). 280x550 mm.
· Soporte para ducha de mano con toma de agua a pared.
· Ducha de mano anticalcárea de latón.
· Flexo satinado.





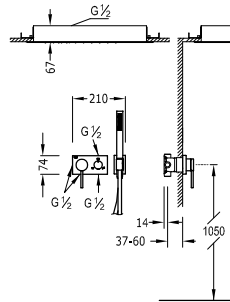
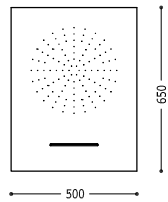



	21027301	1.141,00
	21027301NM	1.769,00
	21027301BM	1.769,00
	21027301AC	1.769,00
	21027301OR	2.282,00
	21027301OM	2.282,00



Kit de grifo monomando empotrado de 3 vías para ducha

- Con cierre y regulación de caudal.
- Cuerpo empotrado incluido.
- Rociador de ducha empotrado a techo de acero inoxidable con 2 tipos de chorro (lluvia/cascada): 500x650 mm.
- Soporte para ducha de mano con toma de agua a pared.
- Ducha de mano anticalcárea de latón.
- Flexo satinado.

	21027303	1.825,00
	21027303NM	2.829,00
	21027303BM	2.829,00
	21027303AC	2.829,00
	21027303OR	3.650,00
	21027303OM	3.650,00

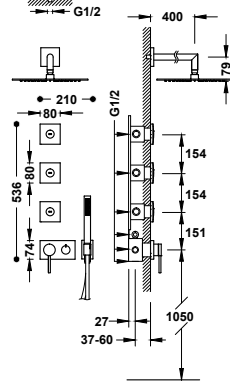
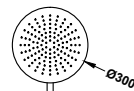

Kit de grifo monomando empotrado de 3 vías para ducha

- Con cierre y regulación de caudal.
- Cuerpo empotrado incluido.
- Brazo a pared con rociador de ducha orientable y de acero inoxidable: Ø 300 mm.
- Soporte para ducha de mano con toma de agua a pared.
- 3 jets empotrados giratorios de hidromasaje.
- Ducha de mano anticalcárea de latón.
- Flexo satinado.

	21027304	1.133,00
---	----------	-----------------

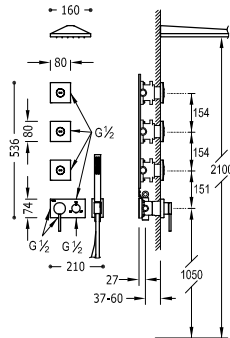
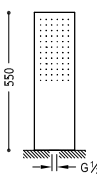

Kit de grifo monomando empotrado de 3 vías para ducha

- Con cierre y regulación de caudal.
- Cuerpo empotrado incluido.
- Rociador de ducha a pared de acero inoxidable: 160x550 mm.
- Soporte para ducha de mano con toma de agua a pared.
- 3 jets empotrados giratorios de hidromasaje.
- Ducha de mano anticalcárea de latón.
- Flexo satinado.

	21027305	1.231,00
---	----------	-----------------



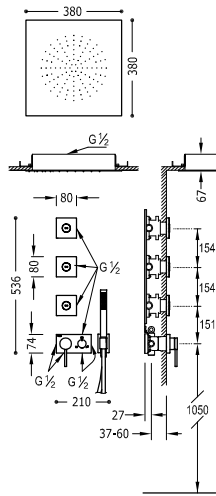

Kit de grifo monomando empotrado de 3 vías para ducha

21027309

1.550,00

- Con cierre y regulación de caudal.
- Cuerpo empotrado incluido.
- Rociador de ducha empotrado a techo de acero inoxidable: 380x380 mm.
- Soporte para ducha de mano con toma de agua a pared.
- 3 jets empotrados giratorios de hidromasaje.
- Ducha de mano anticalcárea de latón.
- Flexo satinado.

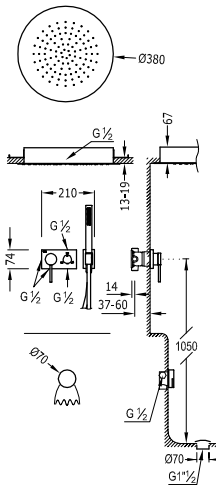

Kit de grifo monomando empotrado de 3 vías para ducha

21027310

1.251,00

- Con cierre y regulación de caudal.
- Cuerpo empotrado incluido.
- Rociador de ducha empotrado a techo de acero inoxidable: Ø 380 mm.
- Soporte para ducha de mano con toma de agua a pared.
- Válvula de desagüe redondo Click-Clack y de llenado con rebosadero para bañera.
- Sifón PVC para bañera.
- Ducha de mano anticalcárea de latón.
- Flexo satinado.

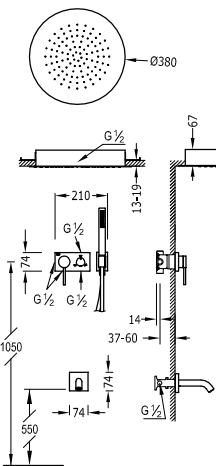

Kit de grifo monomando empotrado de 3 vías para ducha

21027311

1.279,00

- Con cierre y regulación de caudal.
- Cuerpo empotrado incluido.
- Rociador de ducha empotrado a techo de acero inoxidable: Ø 380 mm.
- Soporte para ducha de mano con toma de agua a pared.
- Caño fijo de bañera a pared.
- Ducha de mano anticalcárea de latón.
- Flexo satinado.

21027311NM

1.982,00

21027311BM

1.982,00

21027311AC

1.982,00



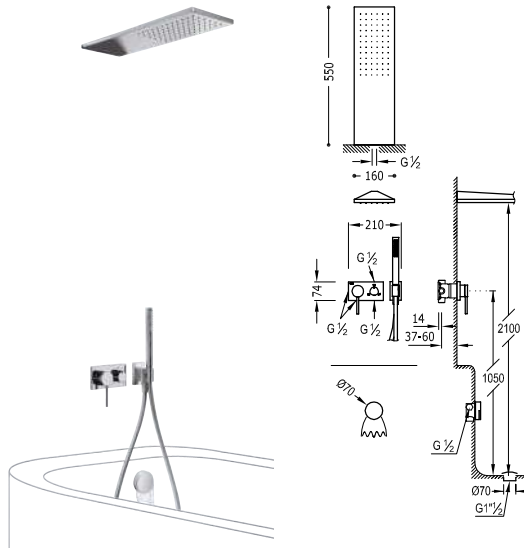

Kit de grifo monomando empotrado de 3 vías para ducha

21027312

931,00

- Con cierre y regulación de caudal.
- Cuerpo empotrado incluido.
- Rociador de ducha a pared de acero inoxidable: 160x550 mm.
- Soporte para ducha de mano con toma de agua a pared.
- Válvula de desagüe redondo Click-Clack y de llenado con rebosadero para bañera.
- Sifón PVC para bañera.
- Ducha de mano anticalcárea de latón.
- Flexo satinado.

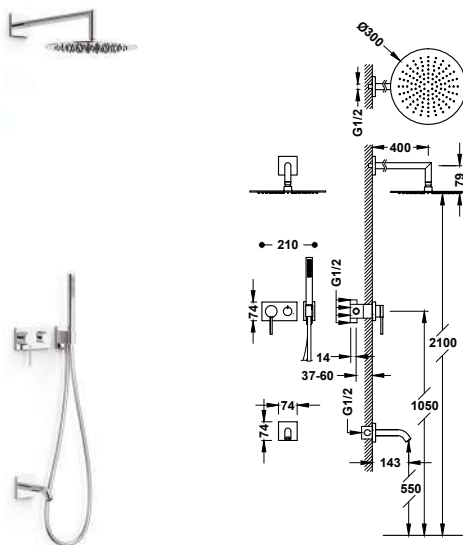

Kit de grifo monomando empotrado de 3 vías para ducha

21027313

862,00

- Con cierre y regulación de caudal.
- Cuerpo empotrado incluido.
- Brazo a pared con rociador de ducha orientable y de acero inoxidable: Ø 300 mm.
- Soporte para ducha de mano con toma de agua a pared.
- Caño fijo de bañera a pared.
- Ducha de mano anticalcárea de latón.
- Flexo satinado.

- 21027313NM **1.336,00**
- 21027313BM **1.336,00**
- 21027313AC **1.336,00**







RAPID-BOX

Rapid-box es el sistema empotrado de Tres para los grifos monomando de ducha. Con diseños que combinan con todas las colecciones de Tres. Se puede adquirir la caja empotrada y la parte vista por separado; de esta manera, la planificación de la obra se simplifica y se gana en eficacia.

Acabados disponibles:





Rapid-box

Un único cuerpo empotrado para los monomandos de ducha de Tres

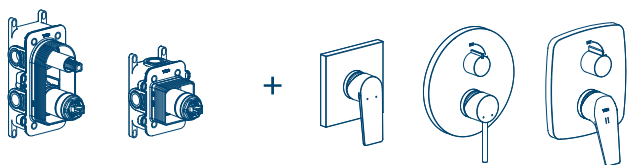

Compra e instala por separado

Puedes instalar la caja Rapid-box y, posteriormente, adquirir la parte vista para instalarla cuando esté todo listo. De esta manera, la planificación de la obra se simplifica y se gana en eficacia.

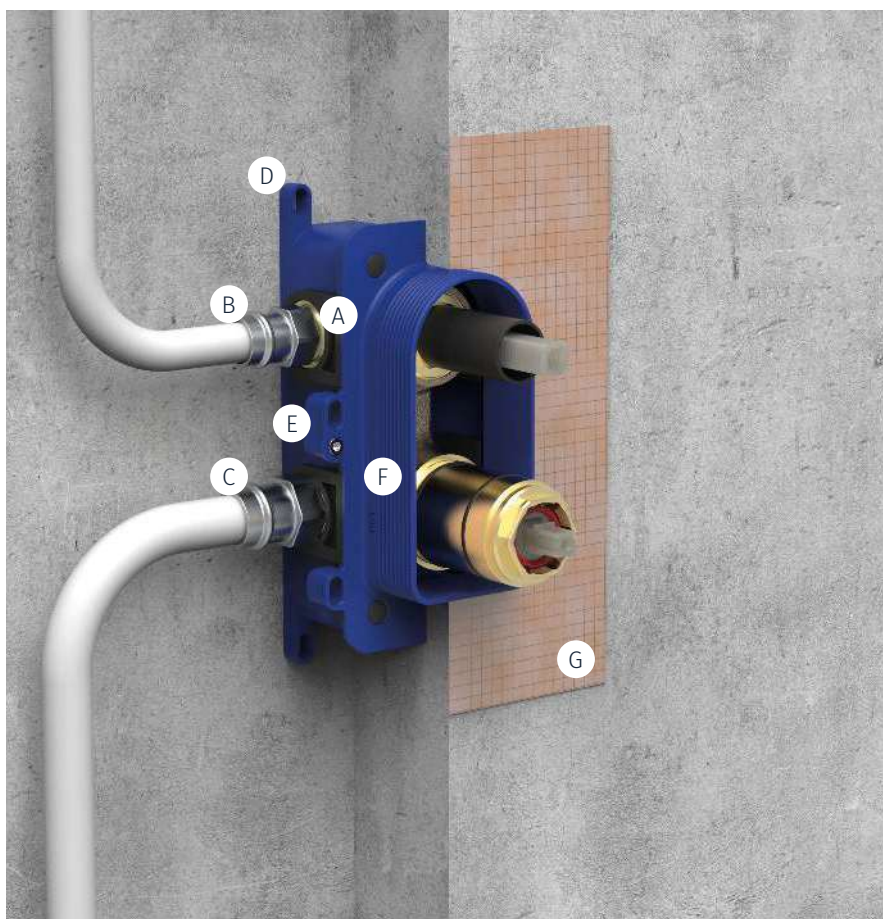

- Ⓐ Amortiguadores acústicos
- Ⓑ Salida de agua G1/2"
- Ⓒ Entrada de agua G1/2"
- Ⓓ Soportes para instalación delantera
- Ⓔ Soportes para instalación trasera
- Ⓕ Marcas de profundidad y ranuras de corte
- Ⓖ Junta de impermeabilización Schlüter®



CAJA EMPOTRADA

Instalación versátil

La caja empotrada Rapid-box permite instalarse por delante o por detrás de la pared, tanto en paredes de obra como paredes ligeras de cartón y yeso (tipo Pladur).

Aislamiento del cuerpo

La caja Rapid-box aísla la transmisión de temperatura del cuerpo de latón hacia la pared. Asimismo, al ser estanca, evita que en caso de fuga el agua se filtre por la pared. La junta impermeable evita las humedades.

Bajo nivel de ruido

Los amortiguadores evitan la transmisión del ruido del grifo a la pared y a la tuberías.



PARTE VISTA

Mayor espacio en la ducha

Las piezas vistas tienen poca profundidad, permitiendo ganar más espacio útil dentro de la ducha.

Diseños adaptables

Las piezas vistas están disponibles en varios acabados y distintos diseños que combinan con las colecciones de Tres.

Facilidad de uso

Para los monomandos de 2 vías, con un sencillo giro del distribuidor se puede cambiar entre las 2 salidas de agua disponibles.

CAJAS EMPOTRADAS

Caja empotrada de 1 vía Rapid-box con grifo monomando para ducha

20827810

80,00

Cuerpo empotrado con amortiguadores acústicos. Caja de empotrar de ABS. Junta antihumedad.

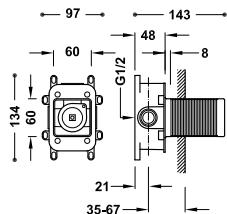

Caja empotrada de 2 vías Rapid-box con grifo monomando para ducha y bañera

20828110

90,00

Cuerpo empotrado con amortiguadores acústicos. Caja de empotrar de ABS. Junta antihumedad. Distribuidor cerámico de 2 vías.

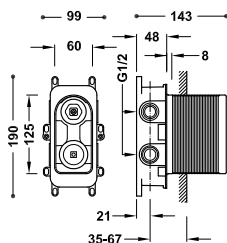

PIEZAS VISTAS DE 1 VÍA

Pieza vista para caja empotrada de 1 vía Rapid-box

Sólo parte vista. Incluye placa embellecedora, mando, casquillo y tornillo de fijación oculto. Completar con la caja empotrada Rapid-box ref.: 20827810.

20227810

85,00

20227810NM

132,00

20227810BM

132,00

20227810AC

132,00

20227810OR

170,00

20227810OM

170,00

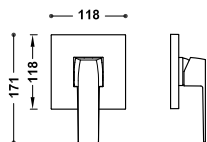

Pieza vista para caja empotrada de 1 vía Rapid-box

Sólo parte vista. Incluye placa embellecedora, mando, casquillo y tornillo de fijación oculto. Completar con la caja empotrada Rapid-box ref.: 20827810.

10627810

85,00

10627810NM

132,00

10627810BM

132,00

10627810AC

132,00

10627810OR

170,00

10627810OM

170,00

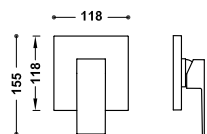

Pieza vista para caja empotrada de 1 vía Rapid-box

Sólo parte vista. Incluye placa embellecedora, mando, casquillo y tornillo de fijación oculto. Completar con la caja empotrada Rapid-box ref.: 20827810.

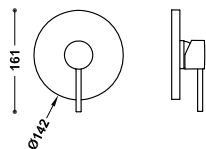

	26227810	85,00
	26227810NM	132,00
	26227810BM	132,00
	26227810AC	132,00
	26227810KM	132,00
	26227810KMB	132,00
	26227810OR	170,00
	26227810OM	170,00
	26227810OP	170,00
	26227810OPM	170,00



Pieza vista para caja empotrada de 1 vía Rapid-box

Sólo parte vista. Incluye placa embellecedora, mando, casquillo y tornillo de fijación oculto. Completar con la caja empotrada Rapid-box ref.: 20827810.

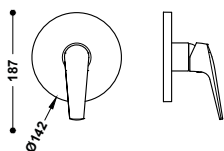

	28127810	75,00
	28127810NM	116,00
	28127810AC	116,00

Pieza vista para caja empotrada de 1 vía Rapid-box

Sólo parte vista. Incluye placa embellecedora, mando, casquillo y tornillo de fijación oculto. Completar con la caja empotrada Rapid-box ref.: 20827810.

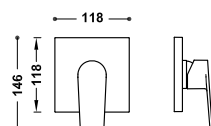

	21127810	75,00
	21127810NM	116,00
	21127810BM	116,00
	21127810AC	116,00
	21127810KM	116,00
	21127810KMB	116,00
	21127810OR	150,00
	21127810OM	150,00
	21127810OP	150,00
	21127810OPM	150,00

Pieza vista para caja empotrada de 1 vía Rapid-box

Sólo parte vista. Incluye placa embellecedora, mando, casquillo y tornillo de fijación oculto. Completar con la caja empotrada Rapid-box ref.: 20827810.

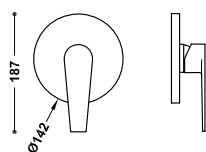

	20527810	75,00
--	----------	--------------

Pieza vista para caja empotrada de 1 vía Rapid-box

06227810

75,00

Sólo parte vista. Incluye placa embellecedora, mando, casquillo y tornillo de fijación oculto. Completar con la caja empotrada Rapid-box ref.: 20827810.

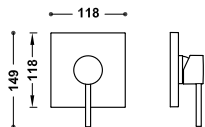

Pieza vista para caja empotrada de 1 vía Rapid-box

21827810

60,00

Sólo parte vista. Incluye placa embellecedora, mando, casquillo y tornillo de fijación oculto. Completar con la caja empotrada Rapid-box ref.: 20827810.

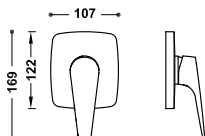

Pieza vista para caja empotrada de 1 vía Rapid-box

21727810

60,00

Sólo parte vista. Incluye placa embellecedora, mando, casquillo y tornillo de fijación oculto. Completar con la caja empotrada Rapid-box ref.: 20827810.

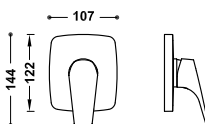

Pieza vista para caja empotrada de 1 vía Rapid-box

20427810

60,00

Sólo parte vista. Incluye placa embellecedora, mando, casquillo y tornillo de fijación oculto. Completar con la caja empotrada Rapid-box ref.: 20827810.

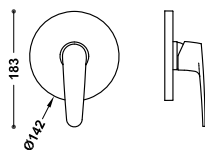

Pieza vista para caja empotrada de 1 vía Rapid-box

Sólo parte vista. Incluye placa embellecedora, mando, casquillo y tornillo de fijación oculto. Completar con la caja empotrada Rapid-box ref.: 20827810.

21627810

55,00

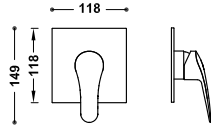

RAPID
BOX



Pieza vista para caja empotrada de 1 vía Rapid-box

Sólo parte vista. Incluye placa embellecedora, mando, casquillo y tornillo de fijación oculto. Completar con la caja empotrada Rapid-box ref.: 20827810.

21527810

55,00

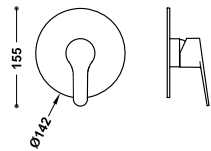

RAPID
BOX

PIEZAS VISTAS DE 2 VÍAS

Pieza vista para caja empotrada de 2 vías Rapid-box

Sólo parte vista. Incluye placa embellecedora, mando, volante distribuidor y tornillo de fijación oculto. Completar con la caja empotrada Rapid-box ref.: 20828110.

20228110

110,00

20228110NM

171,00

20228110BM

171,00

20228110AC

171,00

20228110OR

220,00

20228110OM

220,00

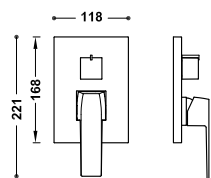

RAPID
BOX

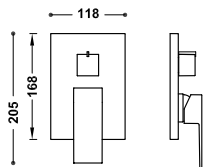

Pieza vista para caja empotrada de 2 vías Rapid-box
 Sólo parte vista. Incluye placa embellecedora, mando, volante distribuidor y tornillo de fijación oculto. Completar con la caja empotrada Rapid-box ref.: 20828110.

- 10628110 **110,00**
- 10628110NM **171,00**
- 10628110BM **171,00**
- 10628110AC **171,00**
- 10628110OR **220,00**
- 10628110OM **220,00**

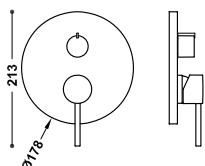

Pieza vista para caja empotrada de 2 vías Rapid-box
 Sólo parte vista. Incluye placa embellecedora, mando, volante distribuidor y tornillo de fijación oculto. Completar con la caja empotrada Rapid-box ref.: 20828110.

- 26228110 **110,00**
- 26228110NM **171,00**
- 26228110BM **171,00**
- 26228110AC **171,00**
- 26228110KM **171,00**
- 26228110KMB **171,00**
- 26228110OR **220,00**
- 26228110OM **220,00**
- 26228110OP **220,00**
- 26228110OPM **220,00**

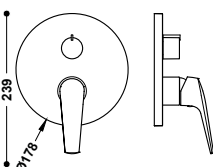

Pieza vista para caja empotrada de 2 vías Rapid-box
 Sólo parte vista. Incluye placa embellecedora, mando, volante distribuidor y tornillo de fijación oculto. Completar con la caja empotrada Rapid-box ref.: 20828110.

- 28128110 **95,00**
- 28128110NM **147,00**
- 28128110AC **147,00**

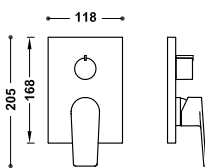

Pieza vista para caja empotrada de 2 vías Rapid-box
 Sólo parte vista. Incluye placa embellecedora, mando, volante distribuidor y tornillo de fijación oculto. Completar con la caja empotrada Rapid-box ref.: 20828110.

- 21128110 **95,00**
- 21128110NM **147,00**
- 21128110BM **147,00**
- 21128110AC **147,00**
- 21128110KM **147,00**
- 21128110KMB **147,00**
- 21128110OR **190,00**
- 21128110OM **190,00**
- 21128110OP **190,00**
- 21128110OPM **190,00**



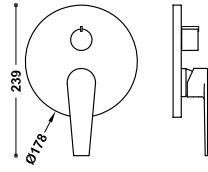

RAPID
BOX

Pieza vista para caja empotrada de 2 vías Rapid-box

Sólo parte vista. Incluye placa embellecedora, mando, volante distribuidor y tornillo de fijación oculto. Completar con la caja empotrada Rapid-box ref.: 20828110.

20528110

95,00

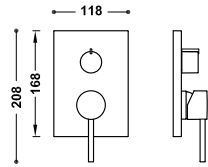

RAPID
BOX

Pieza vista para caja empotrada de 2 vías Rapid-box

Sólo parte vista. Incluye placa embellecedora, mando, volante distribuidor y tornillo de fijación oculto. Completar con la caja empotrada Rapid-box ref.: 20828110.

06228110

95,00

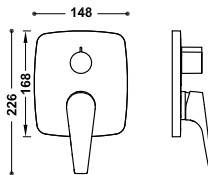

RAPID
BOX

Pieza vista para caja empotrada de 2 vías Rapid-box

Sólo parte vista. Incluye placa embellecedora, mando, volante distribuidor y tornillo de fijación oculto. Completar con la caja empotrada Rapid-box ref.: 20828110.

21828110

75,00

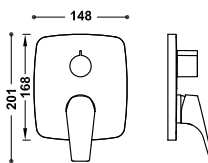

RAPID
BOX

Pieza vista para caja empotrada de 2 vías Rapid-box

Sólo parte vista. Incluye placa embellecedora, mando, volante distribuidor y tornillo de fijación oculto. Completar con la caja empotrada Rapid-box ref.: 20828110.

21728110

75,00

Pieza vista para caja empotrada de 2 vías Rapid-box

20428110

75,00

Sólo parte vista. Incluye placa embellecedora, mando, volante distribuidor y tornillo de fijación oculto. Completar con la caja empotrada Rapid-box ref.: 20828110.

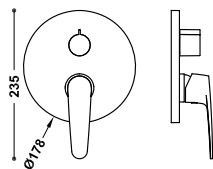

Pieza vista para caja empotrada de 2 vías Rapid-box

21628110

70,00

Sólo parte vista. Incluye placa embellecedora, mando, volante distribuidor y tornillo de fijación oculto. Completar con la caja empotrada Rapid-box ref.: 20828110.

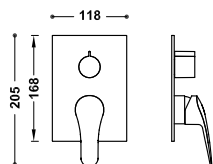

Pieza vista para caja empotrada de 2 vías Rapid-box

21528110

70,00

Sólo parte vista. Incluye placa embellecedora, mando, volante distribuidor y tornillo de fijación oculto. Completar con la caja empotrada Rapid-box ref.: 20828110.

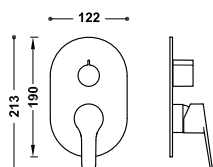



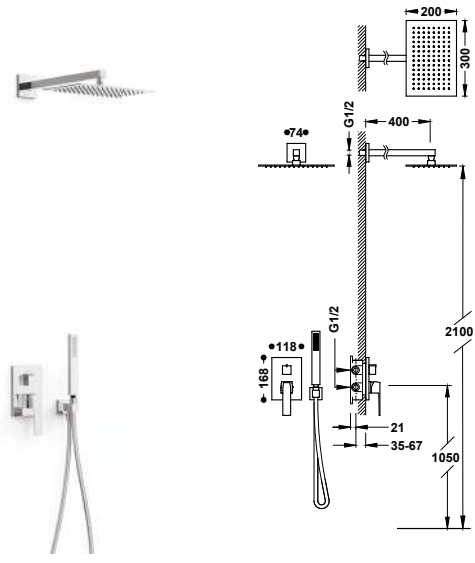



KITS DE 2 VÍAS



Kit de grifo monomando empotrado de 2 vías Rapid-box para ducha





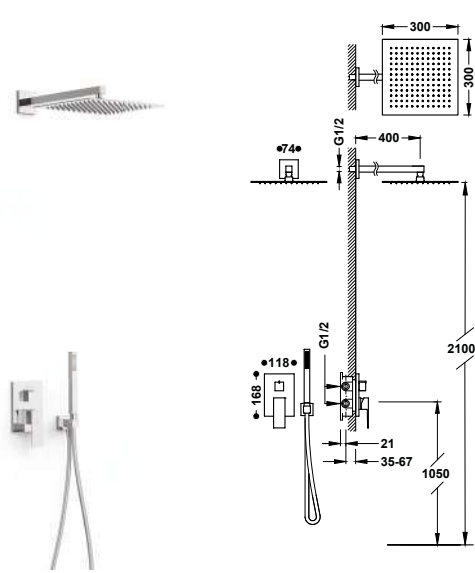

- Cuerpo empotrado incluido.
- Distribuidor cerámico de 2 vías.
- Brazo a pared con rociador de ducha orientable y de acero inoxidable: 300x200 mm.
- Soporte para ducha de mano con toma de agua a pared.
- Ducha de mano anticalcárea de latón.
- Flexo satinado.

	20228004	599,00
	20228004NM	928,00
	20228004BM	928,00
	20228004AC	928,00
	20228004OR	1.198,00
	20228004OM	1.198,00



Kit de grifo monomando empotrado de 2 vías Rapid-box para ducha



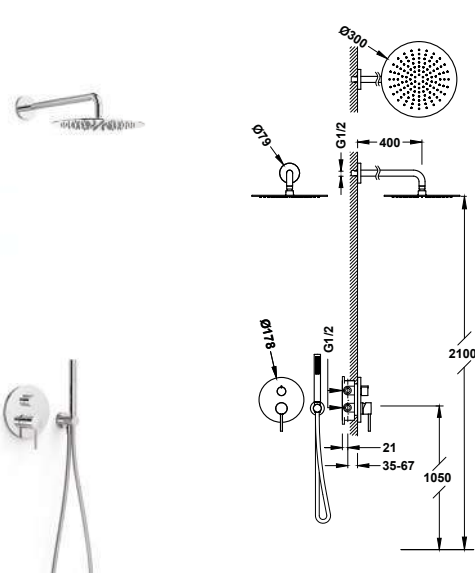

- Cuerpo empotrado incluido.
- Distribuidor cerámico de 2 vías.
- Brazo a pared con rociador de ducha orientable y de acero inoxidable: 300x300 mm.
- Soporte para ducha de mano con toma de agua a pared.
- Ducha de mano anticalcárea de latón.
- Flexo satinado.

	00628004	564,00
	00628004NM	874,00
	00628004BM	874,00
	00628004AC	874,00
	00628004OR	1.128,00
	00628004OM	1.128,00



Kit de grifo monomando empotrado de 2 vías Rapid-box para ducha

- Cuerpo empotrado incluido.
- Distribuidor cerámico de 2 vías.
- Brazo a pared con rociador de ducha orientable y de acero inoxidable: Ø 300 mm.
- Soporte para ducha de mano con toma de agua a pared.
- Ducha de mano anticalcárea de latón.
- Flexo satinado.



	26228004	476,00
	26228004NM	738,00
	26228004BM	738,00
	26228004AC	738,00
	26228004KM	738,00
	26228004KMB	738,00
	26228004OR	952,00
	26228004OM	952,00
	26228004OP	952,00
	26228004OPM	952,00

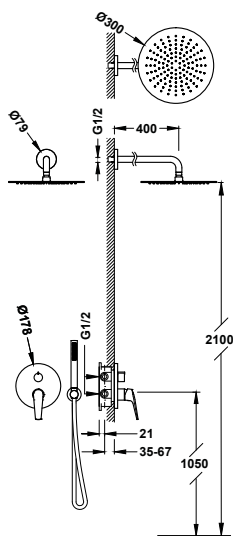



Kit de grifo monomando empotrado de 2 vías Rapid-box para ducha





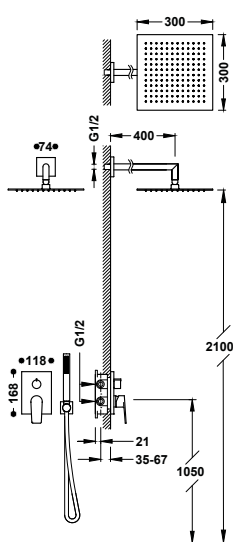





- Cuerpo empotrado incluido.
- Distribuidor cerámico de 2 vías.
- Brazo a pared con rociador de ducha orientable y de acero inoxidable: Ø 300 mm.
- Soporte para ducha de mano con toma de agua a pared.
- Ducha de mano anticalcárea de latón.
- Flexo satinado.

	28128004	446,00
	28128004NM	691,00
	28128004AC	691,00



Kit de grifo monomando empotrado de 2 vías Rapid-box para ducha

- Cuerpo empotrado incluido.
- Distribuidor cerámico de 2 vías.
- Brazo a pared con rociador de ducha orientable y de acero inoxidable: 300x300 mm.
- Soporte para ducha de mano con toma de agua a pared.
- Ducha de mano anticalcárea de latón.
- Flexo satinado.

	21128004	537,00
	21128004NM	832,00
	21128004BM	832,00
	21128004AC	832,00
	21128004KM	832,00
	21128004KMB	832,00
	21128004OR	1.074,00
	21128004OM	1.074,00
	21128004OP	1.074,00
	21128004OPM	1.074,00

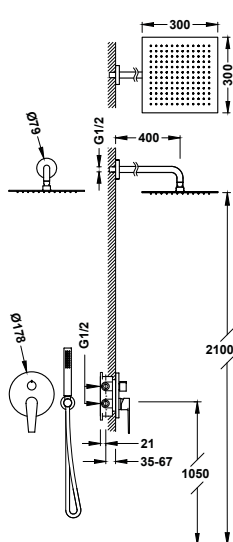

Kit de grifo monomando empotrado de 2 vías Rapid-box para ducha

- Cuerpo empotrado incluido.
- Distribuidor cerámico de 2 vías.
- Brazo a pared con rociador de ducha orientable y de acero inoxidable: 300x300 mm.
- Soporte para ducha de mano con toma de agua a pared.
- Ducha de mano anticalcárea.
- Flexo satinado.

	20528004	419,00
---	----------	---------------



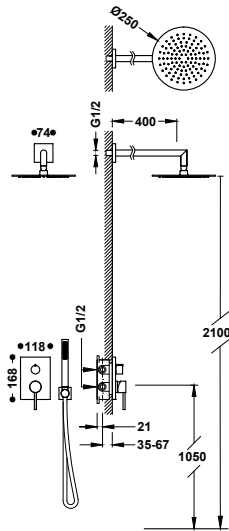

Kit de grifo monomando empotrado de 2 vías Rapid-box para ducha

06228004

414,00

- Cuerpo empotrado incluido.
- Distribuidor cerámico de 2 vías.
- Brazo a pared con rociador de ducha orientable y de acero inoxidable: Ø 250 mm.
- Soporte para ducha de mano con toma de agua a pared.
- Ducha de mano anticalcárea de latón.
- Flexo satinado.



29903508

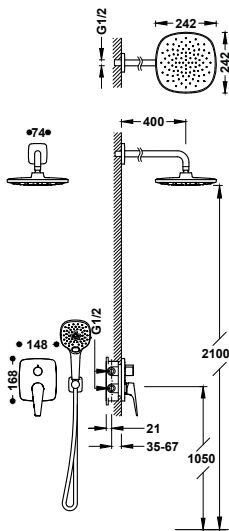

Kit de grifo monomando empotrado de 2 vías Rapid-box para ducha

21828004

369,00

- Cuerpo empotrado incluido.
- Distribuidor cerámico de 2 vías.
- Brazo a pared con rociador de ducha orientable: 242x242 mm.
- Soporte para ducha de mano con toma de agua a pared.
- Ducha de mano anticalcárea 120x120 mm. (3 tipos de chorro).
- Flexo metálico.



29903508

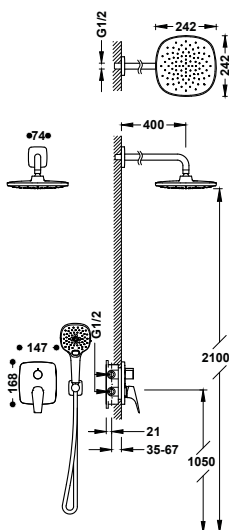

Kit de grifo monomando empotrado de 2 vías Rapid-box para ducha

21728004

368,00

- Cuerpo empotrado incluido.
- Distribuidor cerámico de 2 vías.
- Brazo a pared con rociador de ducha orientable: 242x242 mm.
- Soporte para ducha de mano con toma de agua a pared.
- Ducha de mano anticalcárea 120x120 mm. (3 tipos de chorro).
- Flexo metálico.



29903508

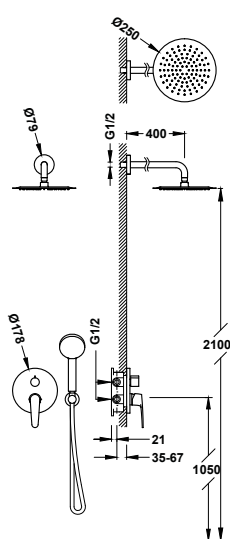

Kit de grifo monomando empotrado de 2 vías Rapid-box para ducha

20428004

357,00

- Cuerpo empotrado incluido.
- Distribuidor cerámico de 2 vías.
- Brazo a pared con rociador de ducha orientable y de acero inoxidable: Ø 250 mm.
- Soporte para ducha de mano con toma de agua a pared.
- Ducha de mano anticalcárea: Ø 110 mm.
- Flexo satinado.



29903508

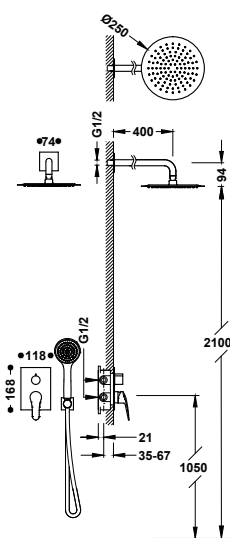

Kit de grifo monomando empotrado de 2 vías Rapid-box para ducha

21628004

334,00

- Cuerpo empotrado incluido.
- Distribuidor cerámico de 2 vías.
- Brazo a pared con rociador de ducha orientable y de acero inoxidable: Ø 250 mm.
- Soporte para ducha de mano con toma de agua a pared.
- Ducha de mano anticalcárea: Ø 100 mm.
- Flexo metálico.



29903508

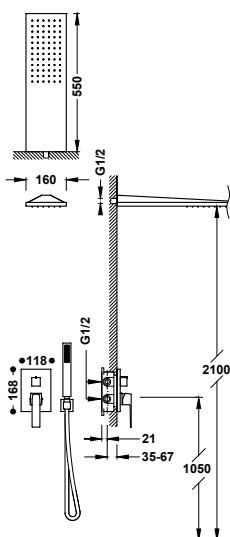

Kit de grifo monomando empotrado de 2 vías Rapid-box para ducha

20228005

743,00

- Cuerpo empotrado incluido.
- Distribuidor cerámico de 2 vías.
- Rociador de ducha a pared de acero inoxidable: 160x550 mm.
- Soporte para ducha de mano con toma de agua a pared.
- Ducha de mano anticalcárea de latón.
- Flexo satinado.

- 20228005NM 1.152,00
- 20228005BM 1.152,00
- 20228005AC 1.152,00
- 20228005OR 1.486,00
- 20228005OM 1.486,00



29903508

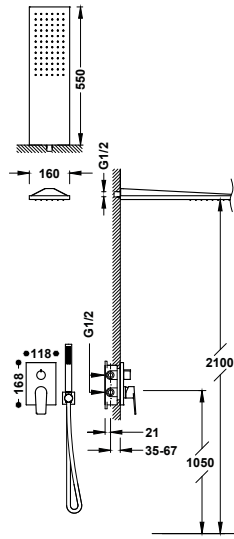

Kit de grifo monomando empotrado de 2 vías Rapid-box para ducha

- Cuerpo empotrado incluido.
- Distribuidor cerámico de 2 vías.
- Rociador de ducha a pared de acero inoxidable: 160x550 mm.
- Soporte para ducha de mano con toma de agua a pared.
- Ducha de mano anticalcárea de latón.
- Flexo satinado.



	21128005	718,00
	21128005NM	1.113,00
	21128005BM	1.113,00
	21128005AC	1.113,00
	21128005KM	1.113,00
	21128005KMB	1.113,00
	21128005OR	1.436,00
	21128005OM	1.436,00
	21128005OP	1.436,00
	21128005OPM	1.436,00 N

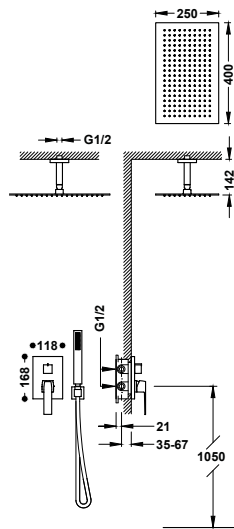

Kit de grifo monomando empotrado de 2 vías Rapid-box para ducha

- Cuerpo empotrado incluido.
- Distribuidor cerámico de 2 vías.
- Brazo a techo con rociador de ducha orientable y de acero inoxidable: 400x250 mm.
- Soporte para ducha de mano con toma de agua a pared.
- Ducha de mano anticalcárea de latón.
- Flexo satinado.



	20228003	624,00
	20228003NM	967,00
	20228003BM	967,00
	20228003AC	967,00
	20228003OR	1.248,00
	20228003OM	1.248,00

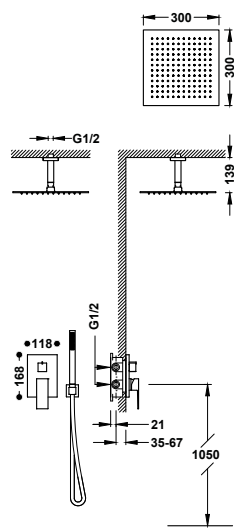

Kit de grifo monomando empotrado de 2 vías Rapid-box para ducha

- Cuerpo empotrado incluido.
- Distribuidor cerámico de 2 vías.
- Brazo a techo con rociador de ducha orientable y de acero inoxidable: 300x300 mm.
- Soporte para ducha de mano con toma de agua a pared.
- Ducha de mano anticalcárea de latón.
- Flexo satinado.





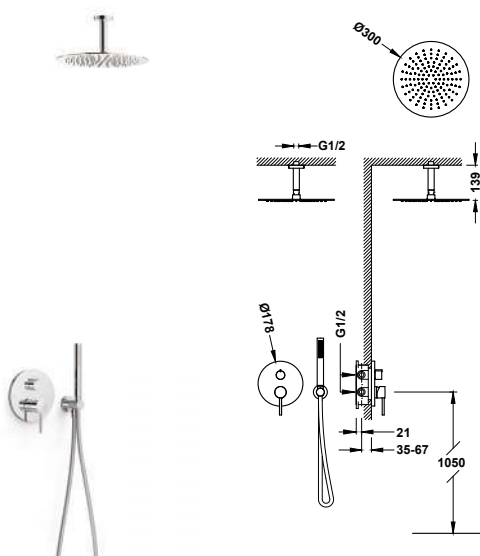

	00628003	542,00
	00628003NM	840,00
	00628003BM	840,00
	00628003AC	840,00
	00628003OR	1.084,00
	00628003OM	1.084,00



Kit de grifo monomando empotrado de 2 vías Rapid-box para ducha





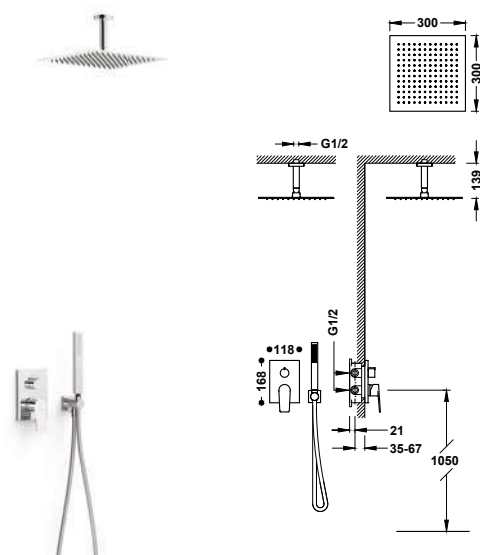





- Cuerpo empotrado incluido.
- Distribuidor cerámico de 2 vías.
- Brazo a techo con rociador de ducha orientable y de acero inoxidable: Ø 300 mm.
- Soporte para ducha de mano con toma de agua a pared.
- Ducha de mano anticalcárea de latón.
- Flexo satinado.

	26228003	451,00
	26228003NM	699,00
	26228003BM	699,00
	26228003AC	699,00
	26228003KM	699,00
	26228003KMB	699,00
	26228003OR	902,00
	26228003OM	902,00
	26228003OP	902,00
	26228003OPM	902,00 



Kit de grifo monomando empotrado de 2 vías Rapid-box para ducha

- Cuerpo empotrado incluido.
- Distribuidor cerámico de 2 vías.
- Brazo a techo con rociador de ducha orientable y de acero inoxidable: 300x300 mm.
- Soporte para ducha de mano con toma de agua a pared.
- Ducha de mano anticalcárea de latón.
- Flexo satinado.

	21128003	504,00
	21128003NM	781,00
	21128003BM	781,00
	21128003AC	781,00
	21128003KM	781,00
	21128003KMB	781,00
	21128003OR	1.008,00
	21128003OM	1.008,00
	21128003OP	1.008,00
	21128003OPM	1.008,00

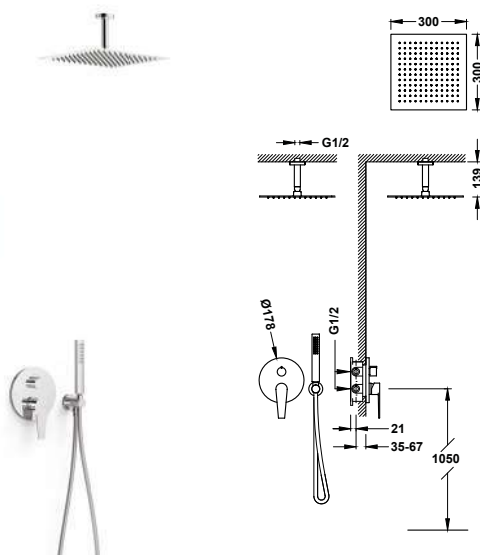

Kit de grifo monomando empotrado de 2 vías Rapid-box para ducha

- Cuerpo empotrado incluido.
- Distribuidor cerámico de 2 vías.
- Brazo a techo con rociador de ducha orientable y de acero inoxidable: 300x300 mm.
- Soporte para ducha de mano con toma de agua a pared.
- Ducha de mano anticalcárea.
- Flexo satinado.

	20528003	400,00
---	----------	---------------



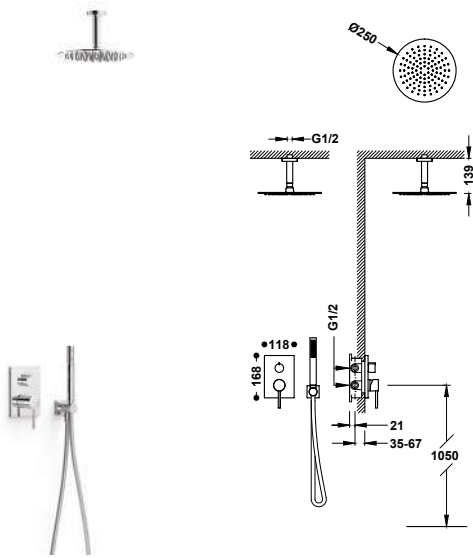

Kit de grifo monomando empotrado de 2 vías Rapid-box para ducha

06228003

364,00

- Cuerpo empotrado incluido.
- Distribuidor cerámico de 2 vías.
- Brazo a techo con rociador de ducha orientable y de acero inoxidable: Ø 250 mm.
- Soporte para ducha de mano con toma de agua a pared.
- Ducha de mano anticalcárea de latón.
- Flexo satinado.

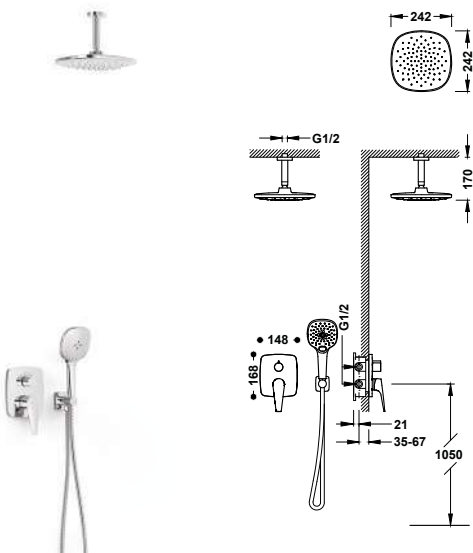

Kit de grifo monomando empotrado de 2 vías Rapid-box para ducha

21828003

341,00

- Cuerpo empotrado incluido.
- Distribuidor cerámico de 2 vías.
- Brazo a techo con rociador de ducha orientable: 242x242 mm.
- Soporte para ducha de mano con toma de agua a pared.
- Ducha de mano anticalcárea 120x120 mm. (3 tipos de chorro).
- Flexo metálico.

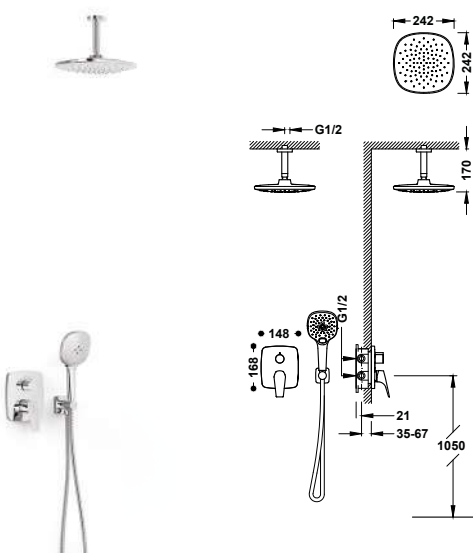

Kit de grifo monomando empotrado de 2 vías Rapid-box para ducha

21728003

341,00

- Cuerpo empotrado incluido.
- Distribuidor cerámico de 2 vías.
- Brazo a techo con rociador de ducha orientable: 242x242 mm.
- Soporte para ducha de mano con toma de agua a pared.
- Ducha de mano anticalcárea 120x120 mm. (3 tipos de chorro).
- Flexo metálico.



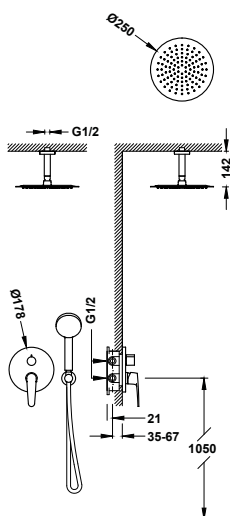

Kit de grifo monomando empotrado de 2 vías Rapid-box para ducha

20428003

338,00

- Cuerpo empotrado incluido.
- Distribuidor cerámico de 2 vías.
- Brazo a techo con rociador de ducha orientable y de acero inoxidable: Ø 250 mm.
- Soporte para ducha de mano con toma de agua a pared.
- Ducha de mano anticalcárea: Ø 110 mm.
- Flexo satinado.

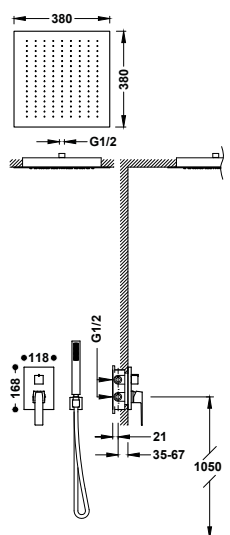

Kit de grifo monomando empotrado de 2 vías Rapid-box para ducha

20228006

1.080,00

- 20228006NM **1.674,00**
- 20228006BM **1.674,00**
- 20228006AC **1.674,00**
- 20228006OR **2.160,00**
- 20228006OM **2.160,00**

- Cuerpo empotrado incluido.
- Distribuidor cerámico de 2 vías.
- Rociador de ducha empotrado a techo de acero inoxidable: 380x380 mm.
- Soporte para ducha de mano con toma de agua a pared.
- Ducha de mano anticalcárea de latón.
- Flexo satinado.

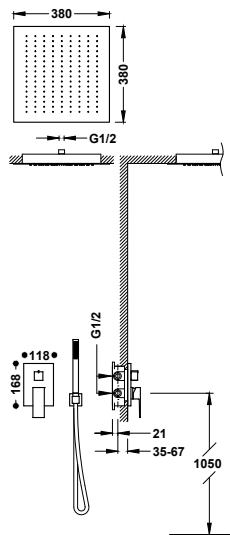

Kit de grifo monomando empotrado de 2 vías Rapid-box para ducha

00628005

1.077,00

- 00628005NM **1.669,00**
- 00628005BM **1.669,00**
- 00628005AC **1.669,00**
- 00628005OR **2.154,00**
- 00628005OM **2.154,00**

- Cuerpo empotrado incluido.
- Distribuidor cerámico de 2 vías.
- Rociador de ducha empotrado a techo de acero inoxidable: 380x380 mm.
- Soporte para ducha de mano con toma de agua a pared.
- Ducha de mano anticalcárea de latón.
- Flexo satinado.



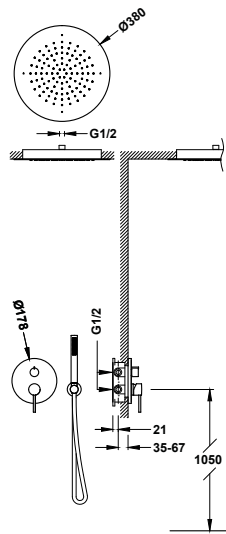

Kit de grifo monomando empotrado de 2 vías Rapid-box para ducha

- Cuerpo empotrado incluido.
- Distribuidor cerámico de 2 vías.
- Rociador de ducha empotrado a techo de acero inoxidable: Ø 380 mm.
- Soporte para ducha de mano con toma de agua a pared.
- Ducha de mano anticalcárea de latón.
- Flexo satinado.

	26228005	1.027,00
	26228005NM	1.592,00
	26228005BM	1.592,00
	26228005AC	1.592,00
	26228005KM	1.592,00
	26228005KMB	1.592,00
	26228005OR	2.054,00
	26228005OM	2.054,00
	26228005OP	2.054,00
	26228005OPM	2.054,00 N

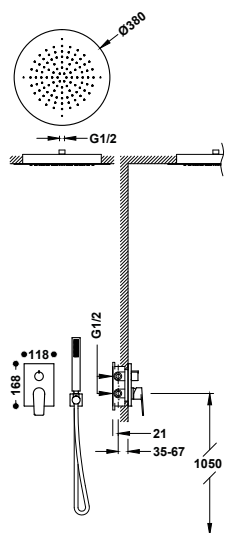

Kit de grifo monomando empotrado de 2 vías Rapid-box para ducha

- Cuerpo empotrado incluido.
- Distribuidor cerámico de 2 vías.
- Rociador de ducha empotrado a techo de acero inoxidable: Ø 380 mm.
- Soporte para ducha de mano con toma de agua a pared.
- Ducha de mano anticalcárea de latón.
- Flexo satinado.

	21128006	1.055,00
	21128006NM	1.635,00
	21128006BM	1.635,00
	21128006AC	1.635,00
	21128006KM	1.635,00
	21128006KMB	1.635,00
	21128006OR	2.110,00
	21128006OM	2.110,00
	21128006OP	2.110,00
	21128006OPM	2.110,00

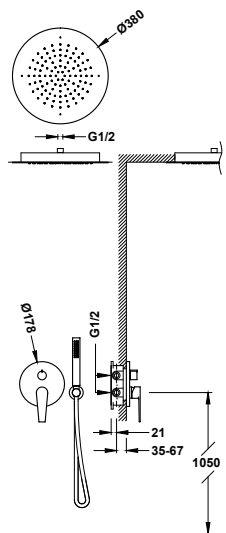

Kit de grifo monomando empotrado de 2 vías Rapid-box para ducha

- Cuerpo empotrado incluido.
- Distribuidor cerámico de 2 vías.
- Rociador de ducha empotrado a techo de acero inoxidable: Ø 380 mm.
- Soporte para ducha de mano con toma de agua a pared.
- Ducha de mano anticalcárea.
- Flexo satinado.

	20528005	806,00
--	----------	---------------



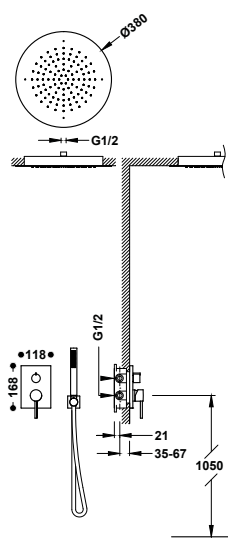

Kit de grifo monomando empotrado de 2 vías Rapid-box para ducha

06228005

820,00

- Cuerpo empotrado incluido.
- Distribuidor cerámico de 2 vías.
- Rociador empotrado a techo de acero inoxidable: Ø 380 mm.
- Soporte para ducha de mano con toma de agua a pared.
- Ducha de mano anticalcárea de latón.
- Flexo satinado.

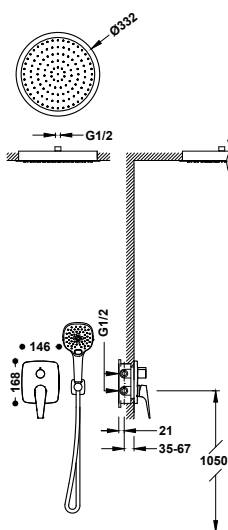

Kit de grifo monomando empotrado de 2 vías Rapid-box para ducha

21828005

589,00

- Cuerpo empotrado incluido.
- Distribuidor cerámico de 2 vías.
- Rociador empotrado a techo de latón: Ø 332 mm.
- Soporte para ducha de mano con toma de agua a pared.
- Ducha de mano anticalcárea 120x120 mm. (3 tipos de chorro).
- Flexo metálico.

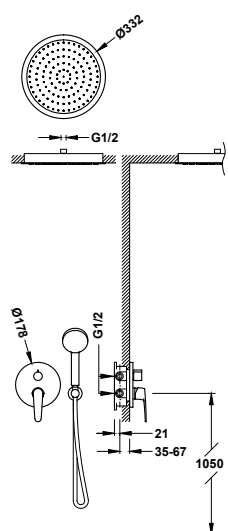

Kit de grifo monomando empotrado de 2 vías Rapid-box para ducha

20428005

599,00

- Cuerpo empotrado incluido.
- Distribuidor cerámico de 2 vías.
- Rociador empotrado a techo de latón: Ø 332 mm.
- Soporte para ducha de mano con toma de agua a pared.
- Ducha de mano anticalcárea: Ø 110 mm.
- Flexo satinado.



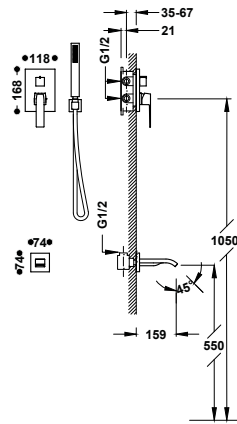

Kit de grifo monomando empotrado de 2 vías Rapid-box para bañera y ducha

- Cuerpo empotrado incluido.
- Distribuidor cerámico de 2 vías.
- Caño fijo de bañera a pared.
- Soporte para ducha de mano con toma de agua a pared.
- Ducha de mano anticalcárea de latón.
- Flexo satinado.



	20228007	472,00
	20228007NM	732,00
	20228007BM	732,00
	20228007AC	732,00
	20228007OR	944,00
	20228007OM	944,00

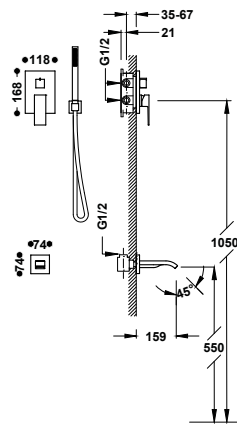

Kit de grifo monomando empotrado de 2 vías Rapid-box para bañera y ducha

- Cuerpo empotrado incluido.
- Distribuidor cerámico de 2 vías.
- Caño fijo de bañera a pared.
- Soporte para ducha de mano con toma de agua a pared.
- Ducha de mano anticalcárea de latón.
- Flexo satinado.



	00628006	469,00
	00628006NM	727,00
	00628006BM	727,00
	00628006AC	727,00
	00628006OR	938,00
	00628006OM	938,00

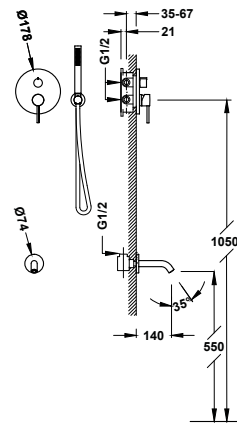

Kit de grifo monomando empotrado de 2 vías Rapid-box para bañera y ducha

- Cuerpo empotrado incluido.
- Distribuidor cerámico de 2 vías.
- Caño fijo de bañera a pared.
- Soporte para ducha de mano con toma de agua a pared.
- Ducha de mano anticalcárea de latón.
- Flexo satinado.



	26228006	366,00
	26228006NM	567,00
	26228006BM	567,00
	26228006AC	567,00
	26228006KM	567,00
	26228006KMB	567,00
	26228006OR	732,00
	26228006OM	732,00
	26228006OP	732,00
	26228006OPM	732,00

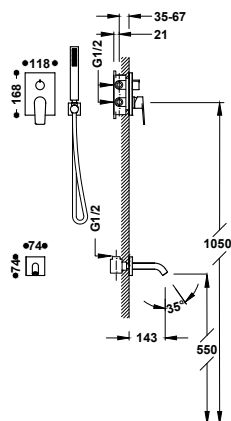

Kit de grifo monomando empotrado de 2 vías Rapid-box para bañera y ducha

- Cuerpo empotrado incluido.
- Distribuidor cerámico de 2 vías.
- Caño fijo de bañera a pared.
- Soporte para ducha de mano con toma de agua a pared.
- Ducha de mano anticalcárea de latón.
- Flexo satinado.

	21128007	394,00
	21128007NM	611,00
	21128007BM	611,00
	21128007AC	611,00
	21128007KM	611,00
	21128007KMB	611,00
	21128007OR	788,00
	21128007OM	788,00
	21128007OP	788,00
	21128007OPM	788,00 N

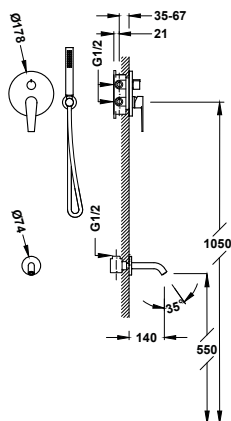

Kit de grifo monomando empotrado de 2 vías Rapid-box para bañera y ducha

- Cuerpo empotrado incluido.
- Distribuidor cerámico de 2 vías.
- Caño fijo de bañera a pared.
- Soporte para ducha de mano con toma de agua a pared.
- Ducha de mano anticalcárea.
- Flexo satinado.

	20528006	319,00
--	----------	---------------

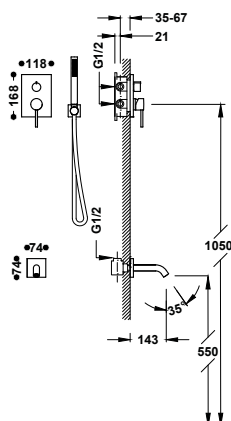

Kit de grifo monomando empotrado de 2 vías Rapid-box para bañera y ducha

- Cuerpo empotrado incluido.
- Distribuidor cerámico de 2 vías.
- Caño fijo de bañera a pared.
- Soporte para ducha de mano con toma de agua a pared.
- Ducha de mano anticalcárea de latón.
- Flexo satinado.

	06228006	333,00
--	----------	---------------



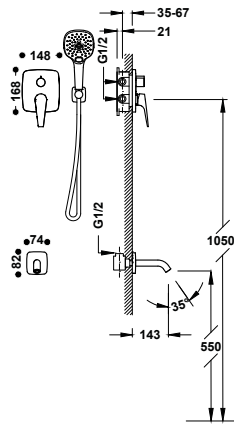

Kit de grifo monomando empotrado de 2 vías Rapid-box para bañera y ducha

21828006

340,00

- Cuerpo empotrado incluido.
- Distribuidor cerámico de 2 vías.
- Caño fijo de bañera a pared.
- Soporte para ducha de mano con toma de agua a pared.
- Ducha de mano anticalcárea 120x120 mm. (3 tipos de chorro).
- Flexo metálico.



29903508

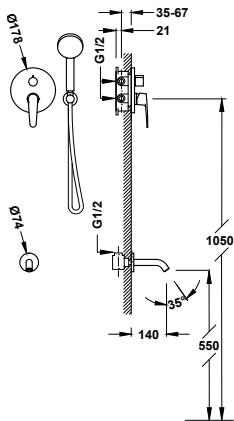

Kit de grifo monomando empotrado de 2 vías Rapid-box para bañera y ducha

20428006

304,00

- Cuerpo empotrado incluido.
- Distribuidor cerámico de 2 vías.
- Caño fijo de bañera a pared.
- Soporte para ducha de mano con toma de agua a pared.
- Ducha de mano anticalcárea: Ø 110 mm.
- Flexo satinado.



29903508

MONOMANDOS EMPOTRADOS

Los monomandos empotrados son una opción muy funcional para equipar la ducha con elementos de diseño minimalista. El manejo cómodo con un solo mando y la facilidad de uso son sus características más destacadas. El cuerpo empotrado y la parte vista de cada artículo se suministra unida, lista para instalar.

Acabados disponibles:

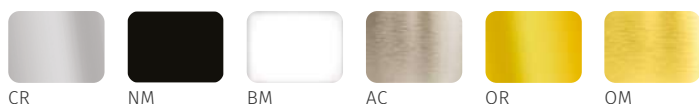



GRIFOS EMPOTRADOS

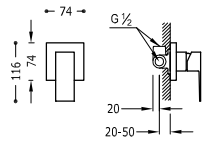

Grifo monomando empotrado de 1 vía para ducha
Cuerpo empotrado incluido.

106177

120,00



Alargadera para grifo monomando empotrado de 1 vía para ducha

10617710

90,00

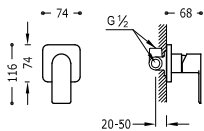

Grifo monomando empotrado de 1 vía para ducha
Cuerpo empotrado incluido.

20017701

110,00

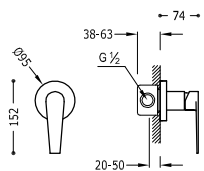

Grifo monomando empotrado de 1 vía para ducha
Cuerpo empotrado incluido.

20517701

92,00

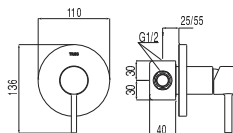

Grifo monomando empotrado de 1 vía para ducha
Cuerpo empotrado incluido.

20317701

95,00



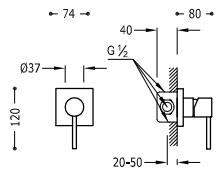

9130190

Grifo monomando empotrado de 1 vía para ducha
Cuerpo empotrado incluido.

06217702

110,00

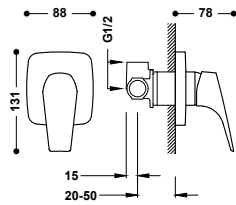

29903503

Grifo monomando empotrado de 1 vía para ducha
Cuerpo empotrado incluido.

21717701

92,00

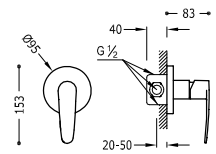

9130190

Grifo monomando empotrado de 1 vía para ducha
Cuerpo empotrado incluido.

20417701

92,00

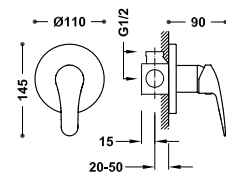

9134592

Grifo monomando empotrado de 1 vía para ducha
Cuerpo empotrado incluido.

21617701

87,00

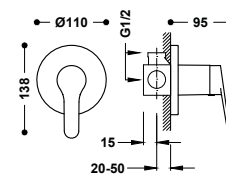

9134592

Grifo monomando empotrado de 1 vía para ducha
Cuerpo empotrado incluido.

21517701

80,00

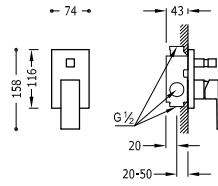

Grifo monomando empotrado de 2 vías para bañera y ducha
Cuerpo empotrado incluido. Inversor de 2 vías.

106180

200,00



Set de prolongación para los grifos monomando empotrado de 2 vías

10618010

124,00

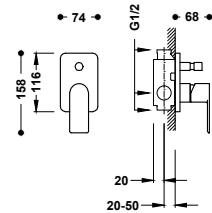

Grifo monomando empotrado de 2 vías para bañera y ducha
Cuerpo empotrado incluido. Inversor de 2 vías.

20018001

170,00

- 20018001NM **264,00**
- 20018001BM **264,00**
- 20018001AC **264,00**
- 20018001OR **340,00**
- 20018001OM **340,00**



Set de prolongación para los grifos monomando empotrado de 2 vías

20018010

95,50

- 20018010OR **191,00** N
- 20018010OM **191,00** N

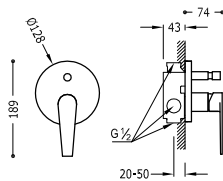

Grifo monomando empotrado de 2 vías para bañera y ducha
Cuerpo empotrado incluido. Inversor de 2 vías.

20518001

132,00

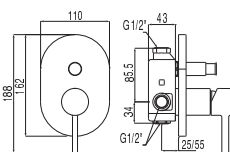

Grifo monomando empotrado de 2 vías para bañera y ducha
Cuerpo empotrado incluido. Inversor de 2 vías.

20318001

145,00



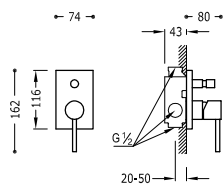

Grifo monomando empotrado de 2 vías para bañera y ducha
Cuerpo empotrado incluido. Inversor de 2 vías.

06218002

170,00

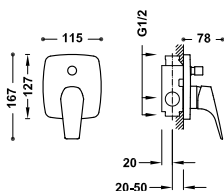

Grifo monomando empotrado de 2 vías para bañera y ducha
Cuerpo empotrado incluido. Inversor de 2 vías.

21718001

132,00

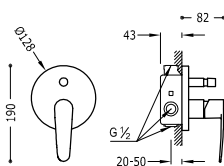

Grifo monomando empotrado de 2 vías para bañera y ducha
Cuerpo empotrado incluido. Inversor de 2 vías.

20418001

132,00

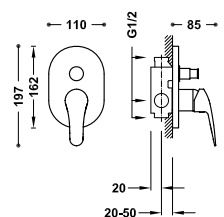

Grifo monomando empotrado de 2 vías para bañera y ducha
Cuerpo empotrado incluido. Inversor de 2 vías.

21618001

122,00

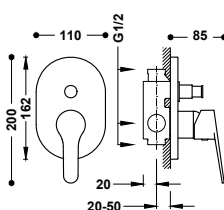

Grifo monomando empotrado de 2 vías para bañera y ducha
Cuerpo empotrado incluido. Inversor de 2 vías.

21518001

115,00



KITS DE 2 VÍAS

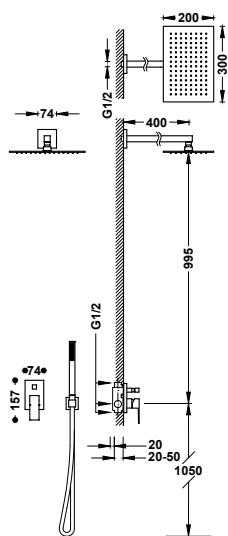

Kit de grifo monomando empotrado de 2 vías para ducha

00698003

596,00

- Cuerpo empotrado incluido.
- Inversor de 2 vías.
- Brazo a pared con rociador de ducha orientable y de acero inoxidable: 300x200 mm.
- Soporte para ducha de mano con toma de agua a pared.
- Ducha de mano anticalcárea de latón.
- Flexo satinado.

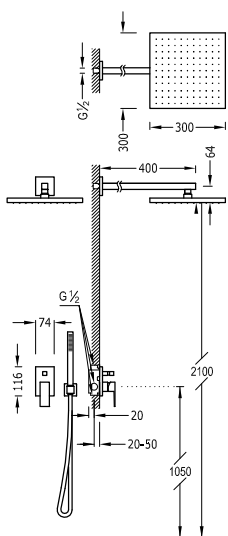

Kit de grifo monomando empotrado de 2 vías para ducha

106980

564,00

- Cuerpo empotrado incluido.
- Inversor de 2 vías.
- Brazo a pared con rociador de ducha orientable y de acero inoxidable: 300x300 mm.
- Soporte para ducha de mano con toma de agua a pared.
- Ducha de mano anticalcárea de latón.
- Flexo satinado.

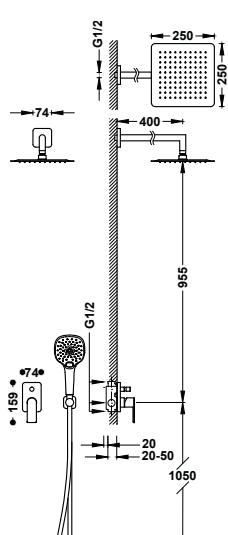

Kit de grifo monomando empotrado de 2 vías para ducha

20018011

456,00

- Cuerpo empotrado incluido.
- Inversor de 2 vías.
- Brazo a pared con rociador de ducha orientable y de acero inoxidable: 250x250mm.
- Soporte para ducha de mano con toma de agua a pared.
- Ducha de mano anticalcárea: 120x120 mm. (3 tipos de chorro).
- Flexo satinado.



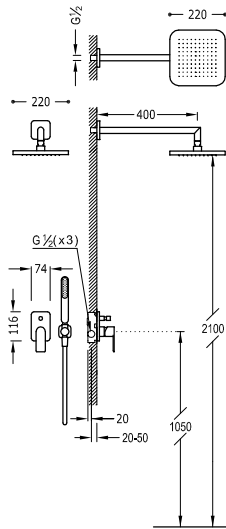

Kit de grifo monomando empotrado de 2 vías para ducha

20018002

482,00

- Cuerpo empotrado incluido.
- Inversor de 2 vías.
- Brazo a pared con rociador de ducha orientable: 220x220 mm.
- Soporte para ducha de mano con toma de agua a pared.
- Ducha de mano anticalcárea.
- Flexo satinado.

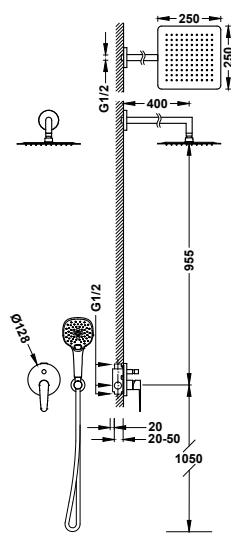

Kit de grifo monomando empotrado de 2 vías para ducha

20518006

410,00

- Cuerpo empotrado incluido.
- Inversor de 2 vías.
- Brazo a pared con rociador de ducha orientable y de acero inoxidable: 250x250 mm.
- Soporte para ducha de mano con toma de agua a pared.
- Ducha de mano anticalcárea: 120x120 mm. (3 tipos de chorro).
- Flexo satinado.

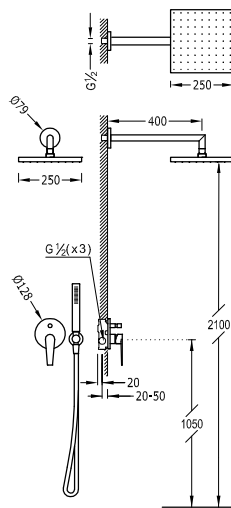

Kit de grifo monomando empotrado de 2 vías para ducha

20518002

405,00

- Cuerpo empotrado incluido.
- Inversor de 2 vías.
- Brazo a pared con rociador de ducha orientable y de acero inoxidable: 250x250 mm.
- Soporte para ducha de mano con toma de agua a pared.
- Ducha de mano anticalcárea.
- Flexo satinado.



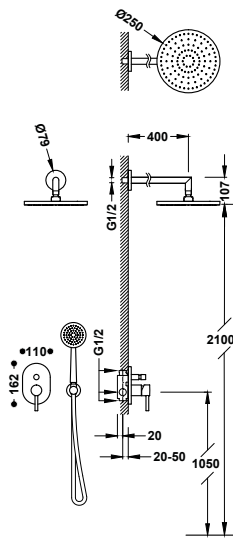

Kit de grifo monomando empotrado de 2 vías para ducha

20318002

395,00

- Cuerpo empotrado incluido.
- Inversor de 2 vías.
- Brazo a pared con rociador de ducha orientable y de acero inoxidable: Ø 250 mm.
- Soporte para ducha de mano con toma de agua a pared.
- Ducha de mano anticalcárea: Ø 100 mm.
- Flexo satinado.

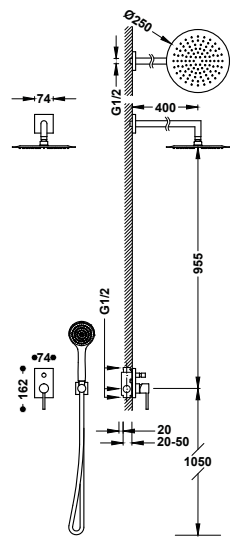

Kit de grifo monomando empotrado de 2 vías para ducha

06298004

427,00

- Cuerpo empotrado incluido.
- Inversor de 2 vías.
- Brazo a pared con rociador de ducha orientable y de acero inoxidable: Ø 250 mm.
- Soporte para ducha de mano con toma de agua a pared.
- Ducha de mano anticalcárea.
- Flexo satinado.

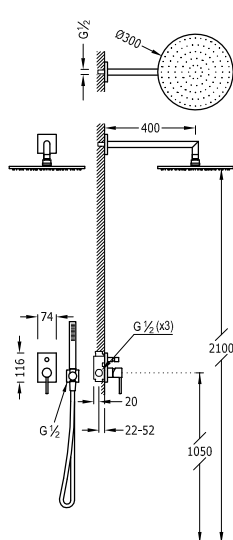

Kit de grifo monomando empotrado de 2 vías para ducha

06298001

489,00

- Cuerpo empotrado incluido.
- Inversor de 2 vías.
- Brazo a pared con rociador de ducha orientable y de acero inoxidable: Ø 300 mm.
- Soporte para ducha de mano con toma de agua a pared.
- Ducha de mano anticalcárea de latón.
- Flexo satinado.



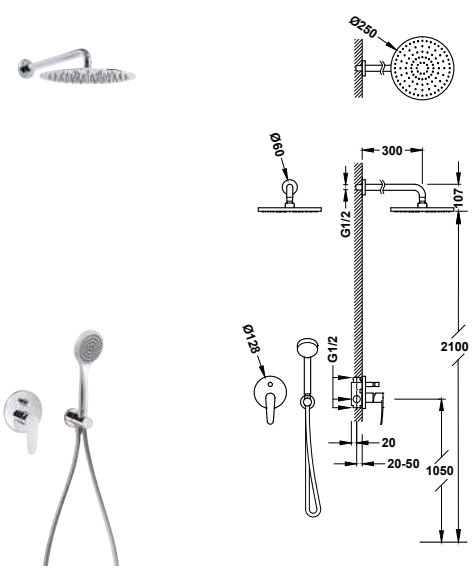

Kit de grifo monomando empotrado de 2 vías para ducha

20418002

369,00

- Cuerpo empotrado incluido.
- Inversor de 2 vías.
- Brazo a pared con rociador de ducha orientable y de acero inoxidable: Ø 250 mm.
- Soporte para ducha de mano con toma de agua a pared.
- Ducha de mano anticalcárea: Ø 100 mm.
- Flexo satinado.

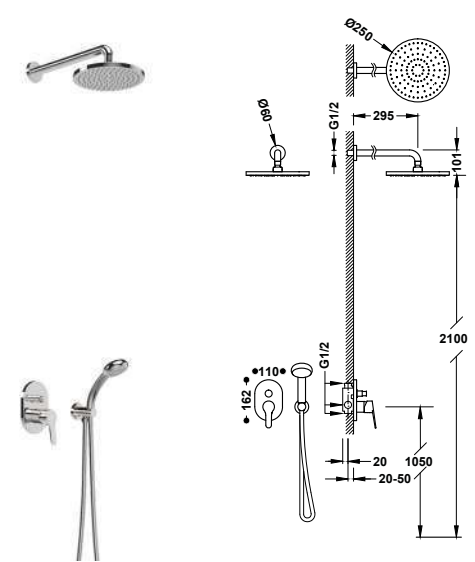

Kit de grifo monomando empotrado de 2 vías para ducha

21599002

241,00

- Cuerpo empotrado incluido.
- Inversor de 2 vías.
- Brazo a pared con rociador de ducha orientable: Ø 250 mm.
- Soporte para ducha de mano con toma de agua a pared.
- Ducha de mano anticalcárea.
- Flexo metálico.

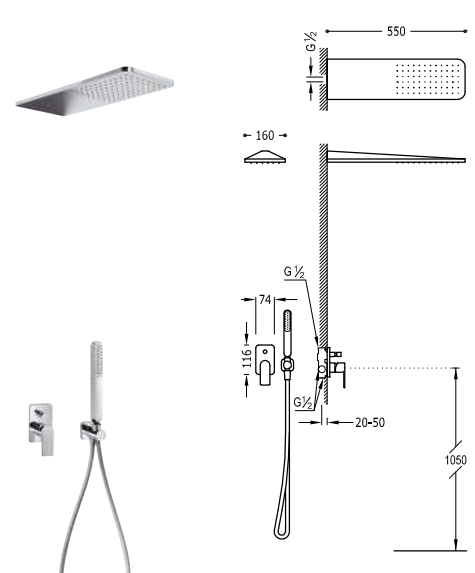

Kit de grifo monomando empotrado de 2 vías para ducha

20018005

750,00

- Cuerpo empotrado incluido.
- Inversor de 2 vías.
- Rociador de ducha a pared de acero inoxidable: 160x550 mm.
- Soporte para ducha de mano con toma de agua a pared.
- Ducha de mano anticalcárea.
- Flexo satinado.

- 20018005NM **1.163,00**
- 20018005BM **1.163,00**
- 20018005AC **1.163,00**
- 20018005OR **1.500,00**
- 20018005OM **1.500,00**

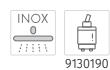

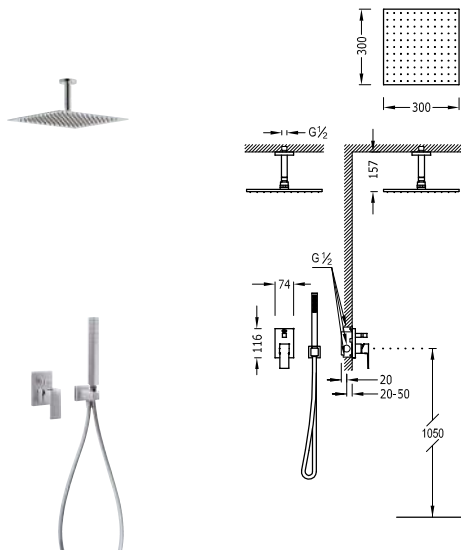

Kit de grifo monomando empotrado de 2 vías para ducha

00618080

542,00

- Cuerpo empotrado incluido.
- Inversor de 2 vías.
- Brazo a techo con rociador de ducha orientable y de acero inoxidable: 300x300 mm.
- Soporte para ducha de mano con toma de agua a pared.
- Ducha de mano anticalcárea de latón.
- Flexo satinado.

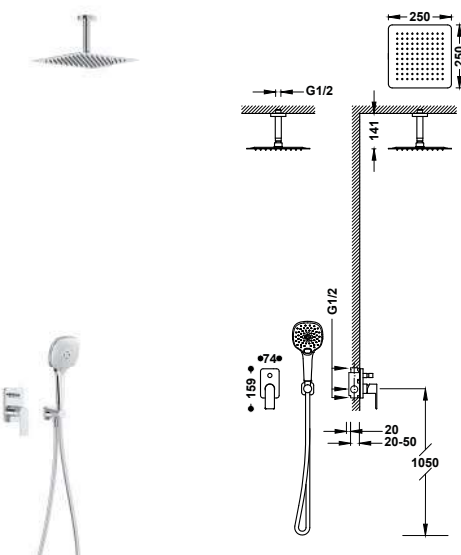

Kit de grifo monomando empotrado de 2 vías para ducha

20018009

422,00

- Cuerpo empotrado incluido.
- Inversor de 2 vías.
- Brazo a techo con rociador de ducha orientable y de acero inoxidable: 250x250mm.
- Soporte para ducha de mano con toma de agua a pared.
- Ducha de mano anticalcárea: 120x120 mm. (3 tipos de chorro).
- Flexo satinado.

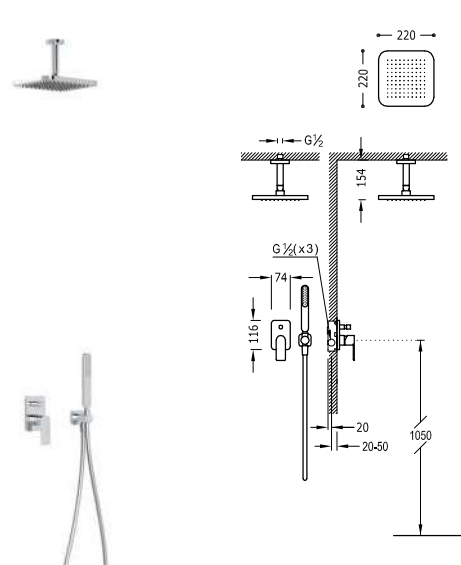

Kit de grifo monomando empotrado de 2 vías para ducha

20018080

449,00

- Cuerpo empotrado incluido.
- Inversor de 2 vías.
- Brazo a techo con rociador de ducha orientable: 220x220 mm.
- Soporte para ducha de mano con toma de agua a pared.
- Ducha de mano anticalcárea.
- Flexo satinado.



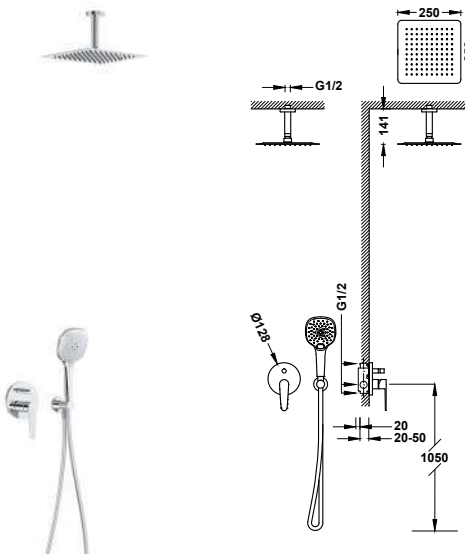

Kit de grifo monomando empotrado de 2 vías para ducha

20518007

384,00

- Cuerpo empotrado incluido.
- Inversor de 2 vías.
- Brazo a techo con rociador de ducha orientable y de acero inoxidable: 250x250 mm.
- Soporte para ducha de mano con toma de agua a pared.
- Ducha de mano anticalcárea: 120x120 mm. (3 tipos de chorro).
- Flexo satinado.

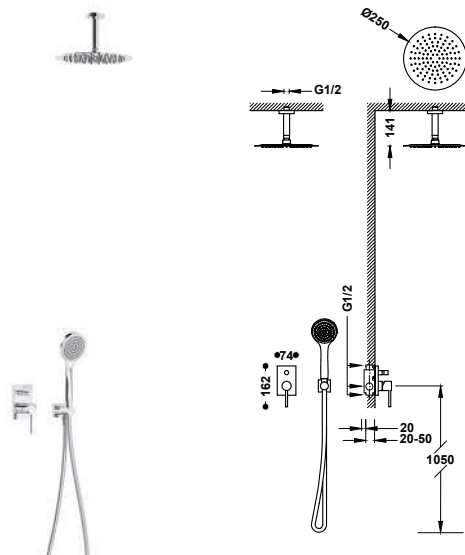

Kit de grifo monomando empotrado de 2 vías para ducha

06218081

394,00

- Cuerpo empotrado incluido.
- Inversor de 2 vías.
- Brazo a techo con rociador de ducha orientable y de acero inoxidable: Ø 250 mm.
- Soporte para ducha de mano con toma de agua a pared.
- Ducha de mano anticalcárea.
- Flexo satinado.

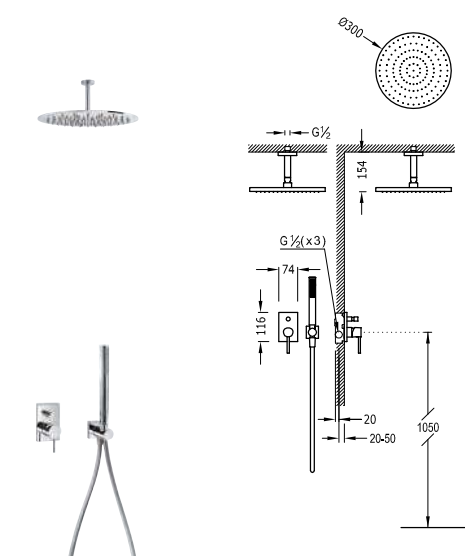
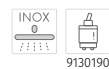

Kit de grifo monomando empotrado de 2 vías para ducha

06218080

456,00

- Cuerpo empotrado incluido.
- Inversor de 2 vías.
- Brazo a techo con rociador de ducha orientable y de acero inoxidable: Ø 300 mm.
- Soporte para ducha de mano con toma de agua a pared.
- Ducha de mano anticalcárea de latón.
- Flexo satinado.



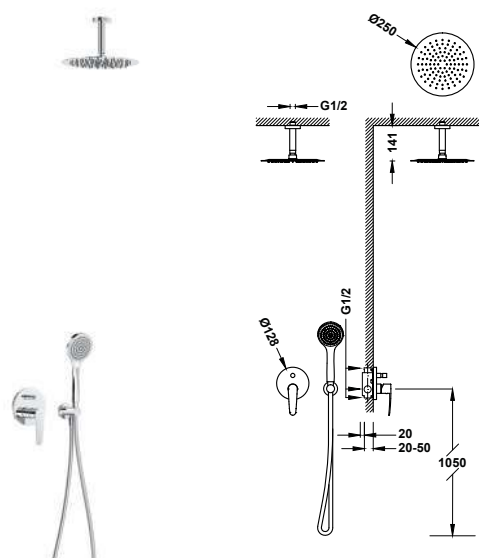

Kit de grifo monomando empotrado de 2 vías para ducha

20418005

356,00

- Cuerpo empotrado incluido.
- Inversor de 2 vías.
- Brazo a techo con rociador de ducha orientable y de acero inoxidable: Ø 250 mm.
- Soporte para ducha de mano con toma de agua a pared.
- Ducha de mano anticalcárea: Ø 100 mm.
- Flexo satinado.





MONOMANDOS MURALES

Los monomandos para la ducha son una solución sencilla y de fácil instalación con diferentes diseños y formas que se adaptan a cualquier espacio. Destacan por su funcionalidad, un manejo cómodo desde un solo mando y alta resistencia al paso del tiempo.

Acabados disponibles:



CR



NM



BM



AC

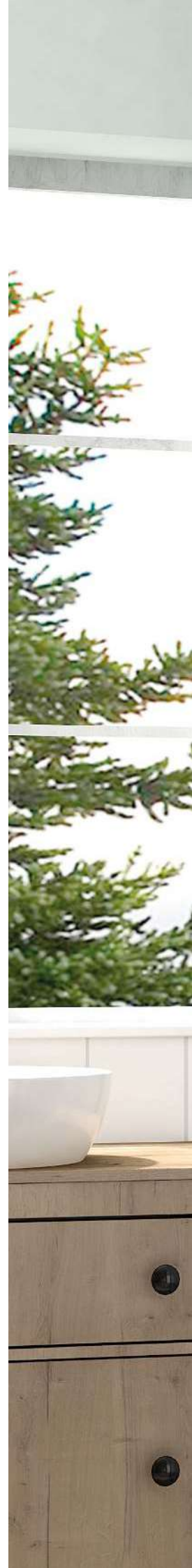





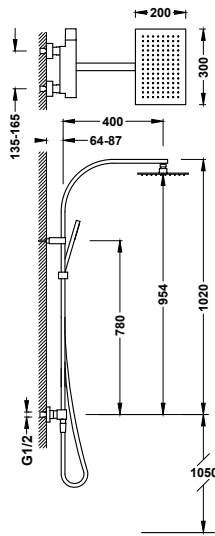

CONJUNTOS MONOMADO PARA DUCHA



Conjunto de grifo monomando mural de 2 vías para ducha

- Rociador de ducha orientable de acero inoxidable: 300x200 mm.
- Soporte deslizante y orientable para ducha de mano.
- Ducha de mano anticalcárea de latón.
- Flexo satinado.

	20219101	720,00
	20219101NM	1.116,00
	20219101BM	1.116,00
	20219101AC	1.116,00

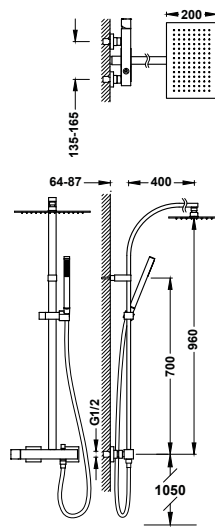

Conjunto de grifo monomando mural de 2 vías para ducha

- Rociador de ducha orientable de acero inoxidable: 300x200 mm.
- Soporte deslizante y orientable para ducha de mano.
- Ducha de mano anticalcárea de latón.
- Flexo satinado.

	00719102	667,00
---	----------	---------------

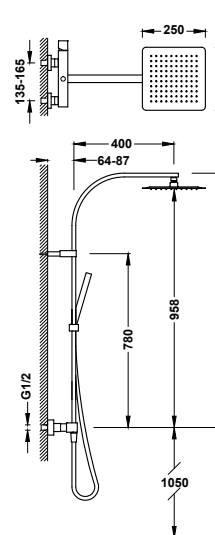

Conjunto de grifo monomando mural de 2 vías para ducha

- Rociador de ducha orientable de acero inoxidable: 250x250 mm.
- Soporte deslizante y orientable para ducha de mano.
- Ducha de mano anticalcárea de latón.
- Flexo satinado.

	00719101	633,00
---	----------	---------------



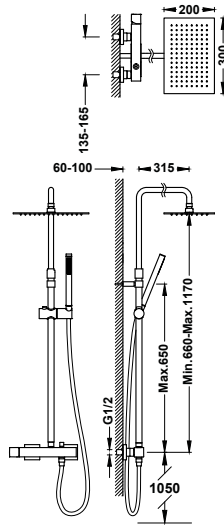

Conjunto de grifo monomando mural de 2 vías para ducha

00719702

616,00

- Rociador de ducha orientable de acero inoxidable: 300x200 mm.
- Barra de ducha telescópica.
- Soporte deslizante y orientable para ducha de mano.
- Ducha de mano anticalcárea de latón.
- Flexo satinado.

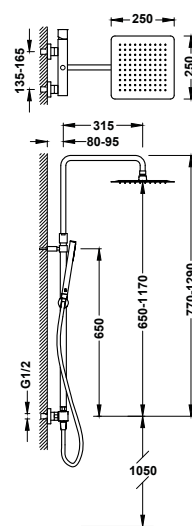

Conjunto de grifo monomando mural de 2 vías para ducha

00719701

585,00

- Rociador de ducha orientable de acero inoxidable: 250x250 mm.
- Barra de ducha telescópica.
- Soporte deslizante y orientable para ducha de mano.
- Ducha de mano anticalcárea de latón.
- Flexo satinado.

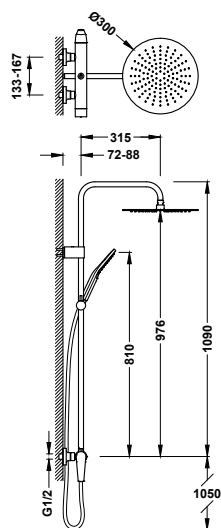

Conjunto de grifo monomando mural de 2 vías para ducha

28119101

473,00

- Rociador de ducha orientable de acero inoxidable: Ø 300 mm.
- Soporte deslizante y orientable para ducha de mano.
- Ducha de mano anticalcárea: Ø 110 mm. (3 tipos de chorro).
- Flexo satinado.

28119101NM

733,00

28119101AC



733,00

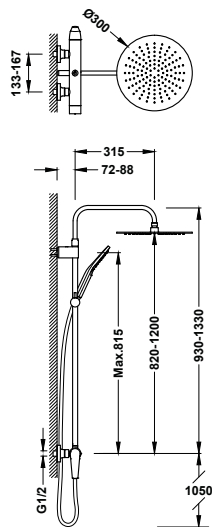



Conjunto de grifo monomando mural de 2 vías para ducha

- Rociador de ducha orientable de acero inoxidable: Ø 300 mm.
- Barra de ducha telescópica.
- Soporte deslizante y orientable para ducha de mano.
- Ducha de mano anticalcárea: Ø 110 mm. (3 tipos de chorro).
- Flexo satinado.

	28119701	503,00
	28119701NM	780,00
	28119701AC	780,00

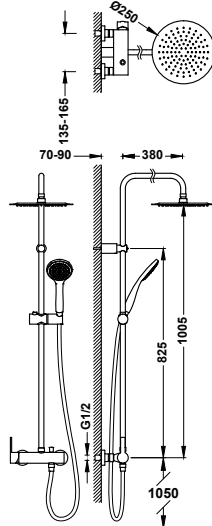
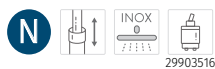

Conjunto de grifo monomando mural de 2 vías para ducha

- Rociador de ducha orientable de acero inoxidable: Ø 250 mm.
- Soporte deslizante y orientable para ducha de mano.
- Ducha de mano anticalcárea: Ø 100 mm.
- Flexo satinado.

	18119102	423,00
---	----------	---------------

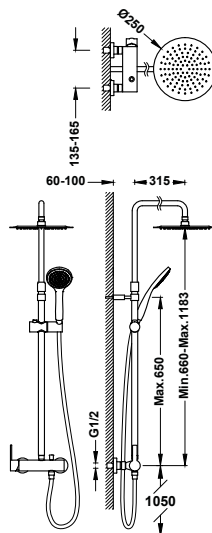

Conjunto de grifo monomando mural de 2 vías para ducha

- Rociador de ducha orientable de acero inoxidable: Ø 250 mm.
- Barra de ducha telescópica.
- Soporte deslizante y orientable para ducha de mano.
- Ducha de mano anticalcárea: Ø 100 mm.
- Flexo satinado.

	08119703	466,00
---	----------	---------------



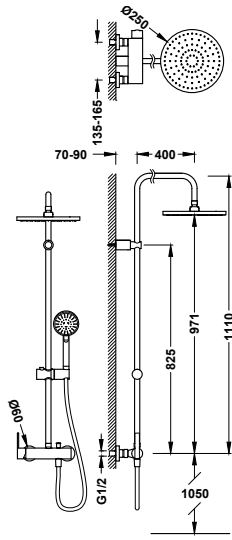

Conjunto de grifo monomando mural de 2 vías para ducha

181191

423,00

- Rociador de ducha orientable de acero inoxidable: Ø 250 mm.
- Soporte deslizante y orientable para ducha de mano.
- Ducha de mano anticalcárea: Ø 100 mm. (5 tipos de chorro).
- Flexo satinado.

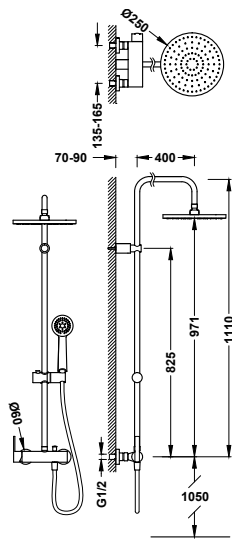

Conjunto de grifo monomando mural de 2 vías para ducha

081192

387,00

- Rociador de ducha orientable de acero inoxidable: Ø 250 mm.
- Soporte deslizante y orientable para ducha de mano.
- Ducha de mano anticalcárea: Ø 100 mm.
- Flexo metálico reforzado.

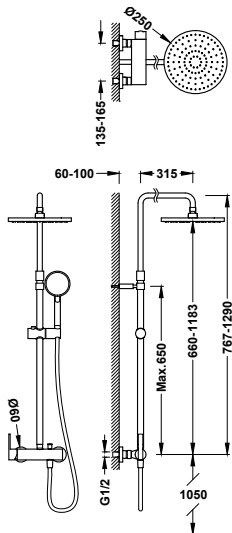

Conjunto de grifo monomando mural de 2 vías para ducha

08119702

498,00

- Rociador de ducha orientable de acero inoxidable: Ø 250 mm.
- Barra de ducha telescópica.
- Soporte deslizante y orientable para ducha de mano.
- Ducha de mano anticalcárea: Ø 100 mm. (5 tipos de chorro).
- Flexo satinado.



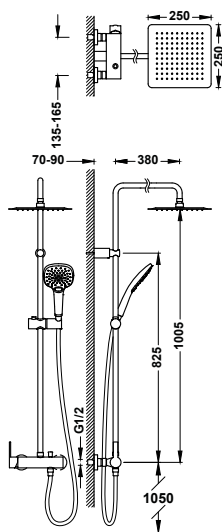

Conjunto de grifo monomando mural de 2 vías para ducha

08119302

421,00

- Rociador de ducha orientable de acero inoxidable: 250x250 mm.
- Soporte deslizante y orientable para ducha de mano.
- Ducha de mano anticalcárea: 120x120 mm. (3 tipos de chorro).
- Flexo satinado.

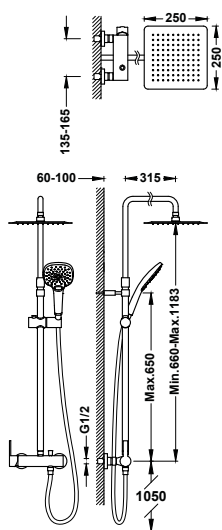

Conjunto de grifo monomando mural de 2 vías para ducha

08119704

496,00

- Rociador de ducha orientable de acero inoxidable: 250x250 mm.
- Barra de ducha telescópica.
- Soporte deslizante y orientable para ducha de mano.
- Ducha de mano anticalcárea: 120x120 mm. (3 tipos de chorro).
- Flexo satinado.

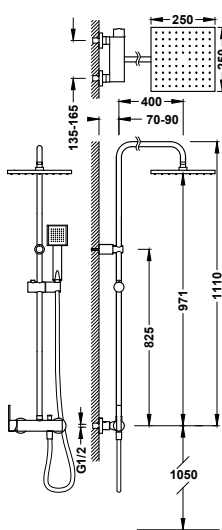

Conjunto de grifo monomando mural de 2 vías para ducha

08119301

414,00

- Rociador de ducha orientable de acero inoxidable: 250x250 mm.
- Soporte deslizante y orientable para ducha de mano.
- Ducha de mano anticalcárea: 80x80 mm.
- Flexo satinado.



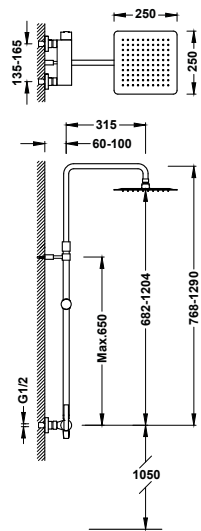

Conjunto de grifo monomando mural de 2 vías para ducha

08119701

489,00

- Rociador de ducha orientable de acero inoxidable: 250x250 mm.
- Barra de ducha telescópica.
- Soporte deslizante y orientable para ducha de mano.
- Ducha de mano anticalcárea.
- Flexo satinado.

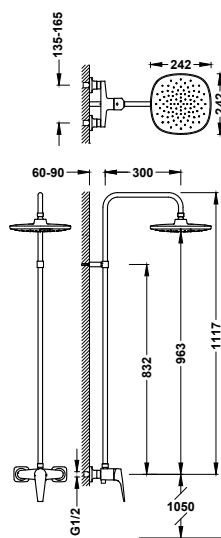

Conjunto de grifo monomando mural de 1 vía para ducha

21899501

268,00

- Rociador de ducha orientable: 242x242 mm.

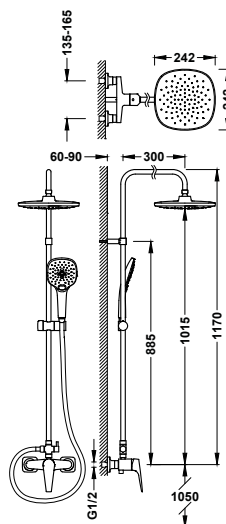

Conjunto de grifo monomando mural de 2 vías para ducha

21819101

301,00

- Con inversor integrado en la barra de ducha.
- Rociador de ducha orientable: 242x242 mm.
- Soporte deslizante y orientable para ducha de mano.
- Ducha de mano anticalcárea 120x120 mm. (3 tipos de chorro).
- Flexo metálico.



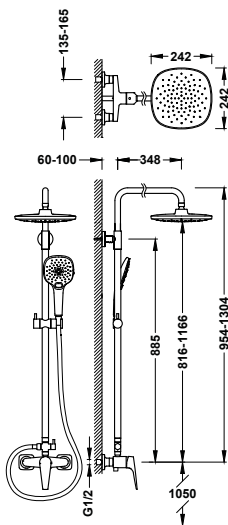

Conjunto de grifo monomando mural de 2 vías para ducha

21831221

431,00

- Con inversor integrado en la barra de ducha.
- Barra de ducha telescópica.
- Rociador de ducha orientable: 242x242 mm.
- Soporte deslizante y orientable para ducha de mano.
- Ducha de mano anticalcárea 120x120 mm. (3 tipos de chorro).
- Flexo metálico.

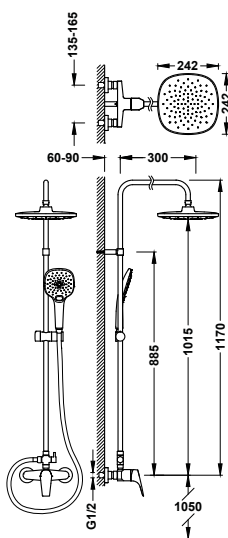
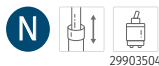

Conjunto de grifo monomando mural de 2 vías para ducha

21719101

293,00

- Con inversor integrado en la barra de ducha.
- Rociador de ducha orientable: 242x242 mm.
- Soporte deslizante y orientable para ducha de mano.
- Ducha de mano anticalcárea 120x120 mm. (3 tipos de chorro).
- Flexo metálico.

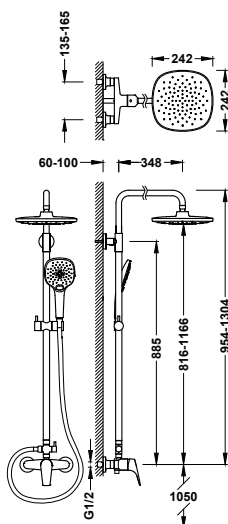

Conjunto de grifo monomando mural de 2 vías para ducha

21731221

445,00

- Con inversor integrado en la barra de ducha.
- Barra de ducha telescópica.
- Rociador de ducha orientable: 242x242 mm.
- Soporte deslizante y orientable para ducha de mano.
- Ducha de mano anticalcárea 120x120 mm. (3 tipos de chorro).
- Flexo metálico.



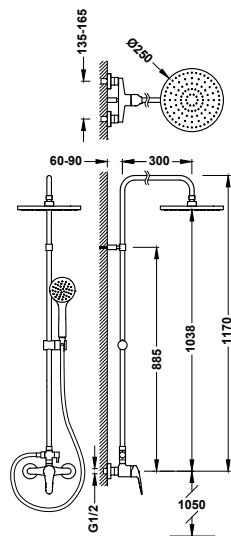

Conjunto de grifo monomando mural de 2 vías para ducha

21619110

309,00

- Con inversor integrado en la barra de ducha.
- Rociador de ducha orientable: Ø 250 mm.
- Soporte deslizable y orientable para ducha de mano.
- Ducha de mano anticalcárea.
- Flexo metálico.



29903504

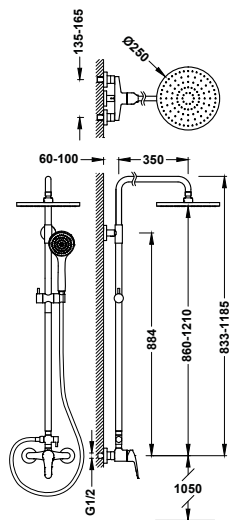

Conjunto de grifo monomando mural de 2 vías para ducha

21631221

439,00

- Con inversor integrado en la barra de ducha.
- Rociador de ducha orientable: Ø 250 mm.
- Barra de ducha telescópica.
- Soporte deslizable y orientable para ducha de mano.
- Ducha de mano anticalcárea.
- Flexo metálico.



29903504

MONOMANDOS PARA BORDE DE BAÑERA

La simplicidad y elegancia de los grifos monomando para borde de bañera se puede complementar con un depósito opcional para una instalación sin registros. El depósito es estanco y comunica con el desagüe de la bañera; incluye una placa de latón embellecedora para mejorar el acabado de la parte visible.

Acabados disponibles:

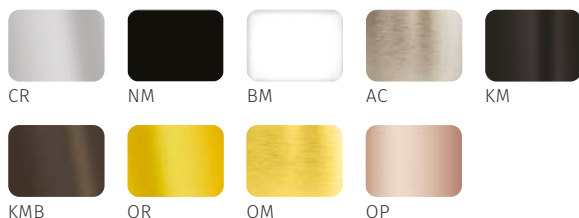





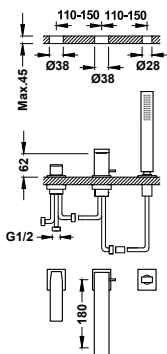



GRIFOS PARA BAÑERA



Grifo monomando para borde de bañera





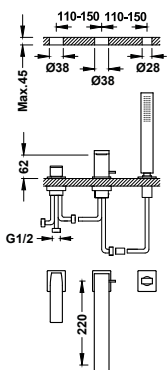

- Inversor integrado en el caño de bañera.
- Ducha de mano anticalcárea de latón.
- Caño de bañera de 180 mm. Caudal: 3 bar - 13 l/m.
- Kit depósito opcional no incluido ref: 20224501.

	20216103	490,00
	20216103NM	760,00
	20216103BM	760,00
	20216103AC	760,00
	20216103OR	980,00
	20216103OM	980,00



Grifo monomando para borde de bañera

- Inversor integrado en el caño de bañera.
- Ducha de mano anticalcárea de latón.
- Caño de bañera de 220 mm. Caudal: 3 bar - 13 l/m.
- Kit depósito opcional no incluido ref: 20224501.

	20216101	500,00
	20216101NM	775,00
	20216101BM	775,00
	20216101AC	775,00
	20216101OR	1.000,00
	20216101OM	1.000,00

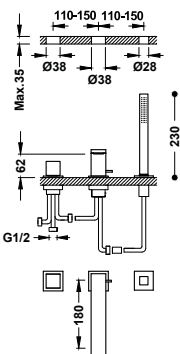

Grifo monomando para borde de bañera

- Inversor integrado en el caño de bañera.
- Ducha de mano anticalcárea de latón.
- Caño de bañera de 180 mm. Caudal: 3 bar - 13 l/min.
- Kit depósito opcional no incluido ref: 20024501.

	00616106	440,00
---	----------	---------------

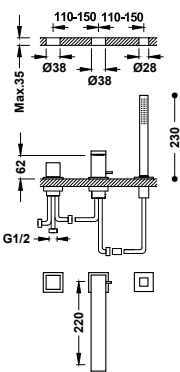

Grifo monomando para borde de bañera

- Inversor integrado en el caño de bañera.
- Ducha de mano anticalcárea de latón.
- Caño de bañera de 220 mm. Caudal: 3 bar - 13 l/min.
- Kit depósito opcional no incluido ref: 20024501.





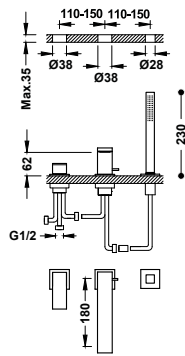

	00616104	450,00
---	----------	---------------





Grifo monomando para borde de bañera





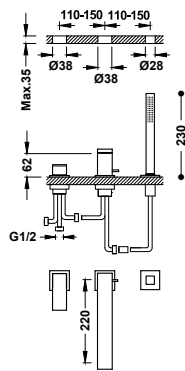

- Inversor integrado en el caño de bañera.
- Ducha de mano anticalcárea de latón.
- Caño de bañera de 180 mm. Caudal: 3 bar - 13 l/m.
- Kit depósito opcional no incluido ref.: 20024501.

	00616105	440,00
	00616105NM	682,00
	00616105BM	682,00
	00616105AC	682,00
	00616105OR	880,00
	00616105OM	880,00



Grifo monomando para borde de bañera

- Inversor integrado en el caño de bañera.
- Ducha de mano anticalcárea de latón.
- Caño de bañera de 220 mm. Caudal: 3 bar - 13 l/m.
- Kit depósito opcional no incluido ref.: 20024501.

	00616103	450,00
	00616103NM	698,00
	00616103BM	698,00
	00616103AC	698,00
	00616103OR	900,00
	00616103OM	900,00

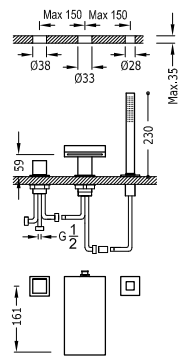

Grifo monomando para borde de bañera

- Inversor integrado en el caño de bañera.
- Ducha de mano anticalcárea de latón.
- Caño de bañera con salida del agua en cascada: 164 mm. Caudal: 3 bar -13 l/min.
- Kit depósito opcional no incluido ref.: 106245.

	10716102	980,00
---	----------	---------------

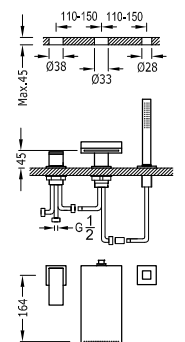

Grifo monomando para borde de bañera

- Inversor integrado en el caño de bañera.
- Ducha de mano anticalcárea de latón.
- Caño de bañera con salida del agua en cascada: 164 mm. Caudal: 3 bar -13 l/min.
- Kit depósito opcional no incluido ref.: 106245.

	10616102	990,00
---	----------	---------------



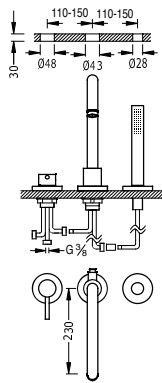

Grifo monomando para borde de bañera

- Inversor integrado en el caño de bañera.
- Ducha de mano anticalcárea de latón.
- Caudal: 3 bar - 14 l/min.
- Kit depósito opcional no incluido ref.: 162245.

26215001

485,00



9134288

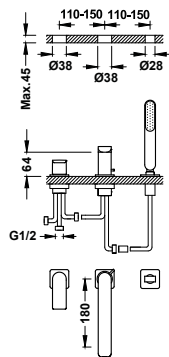

Grifo monomando para borde de bañera

- Inversor integrado en el caño de bañera.
- Ducha de mano anticalcárea.
- Caño de bañera de 180 mm. Caudal: 3 bar - 16 l/min.
- Kit depósito opcional no incluido ref.: 20324501.

20016203

390,00

- 20016203NM **605,00**
- 20016203BM **605,00**
- 20016203AC **605,00**
- 20016203OR **780,00**
- 20016203OM **780,00**



9134591

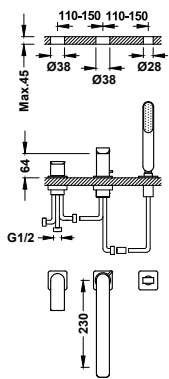

Grifo monomando para borde de bañera

- Inversor integrado en el caño de bañera.
- Ducha de mano anticalcárea.
- Caño de bañera de 220 mm. Caudal: 3 bar - 16 l/m.
- Kit depósito opcional no incluido ref.: 20324501.

20016201

400,00

- 20016201NM **620,00**
- 20016201BM **620,00**
- 20016201AC **620,00**
- 20016201OR **800,00**
- 20016201OM **800,00**



9134591

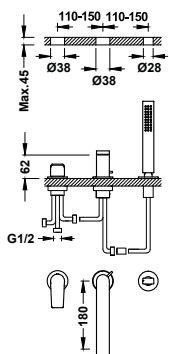

Grifo monomando para borde de bañera

- Inversor integrado en el caño de bañera.
- Ducha de mano anticalcárea de latón.
- Caño de bañera de 180 mm. Caudal: 3 bar - 13 l/min.
- Kit depósito opcional no incluido ref.: 20024501.

21116101

370,00

- 21116101NM **574,00**
- 21116101BM **574,00**
- 21116101AC **574,00**
- 21116101KM **574,00**
- 21116101KMB **574,00**
- 21116101OR **740,00**
- 21116101OM **740,00**
- 21116101OP **740,00**
- 21116101OPM **740,00**





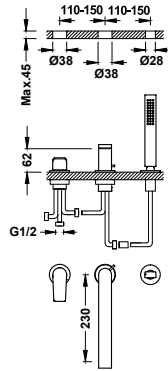







9130190



Grifo monomando para borde de bañera

- Inversor integrado en el caño de bañera.
- Ducha de mano anticalcárea de latón.
- Caño de bañera de 230 mm. Caudal: 3 bar - 13 l/min.
- Kit depósito opcional no incluido ref.: 20024501.

	21116103	380,00
	21116103NM	589,00
	21116103BM	589,00
	21116103AC	589,00
	21116103KM	589,00
	21116103KMB	589,00
	21116103OR	760,00
	21116103OM	760,00
	21116103OP	760,00
	21116103OPM	760,00 N

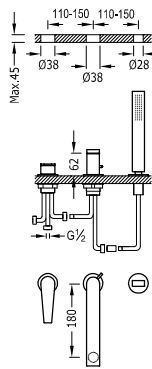

Grifo monomando para borde de bañera

- Inversor integrado en el caño de bañera.
- Ducha de mano anticalcárea.
- Caño de bañera de 180 mm. Caudal: 3 bar - 13 l/m.
- Kit depósito opcional no incluido ref.: 20024501.

	20516103	350,00
---	----------	---------------

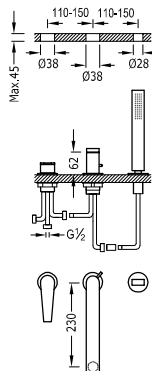

Grifo monomando para borde de bañera

- Inversor integrado en el caño de bañera.
- Ducha de mano anticalcárea.
- Caño de bañera de 230 mm. Caudal: 3 bar - 13 l/m.
- Kit depósito opcional no incluido ref.: 20024501.

	20516101	360,00
---	----------	---------------

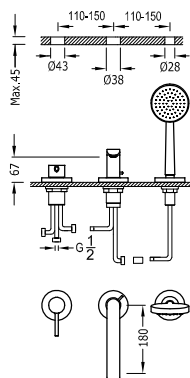

Grifo monomando para borde de bañera

- Inversor integrado en el caño de bañera.
- Ducha de mano anticalcárea: Ø 100 mm.
- Caño de bañera de 180 mm. Caudal: 3 bar - 16 l/m.
- Kit depósito opcional no incluido ref.: 20324501.

	20316102	340,00
---	----------	---------------



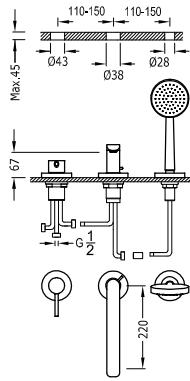

Grifo monomando para borde de bañera

- Inversor integrado en el caño de bañera.
- Ducha de mano anticalcárea: Ø 100 mm.
- Caño de bañera de 220 mm. Caudal: 3 bar - 16 l/m.
- Kit depósito opcional no incluido ref.: 20324501.

20316101

350,00

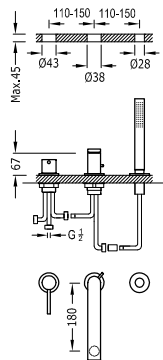

Grifo monomando para borde de bañera

- Inversor integrado en el caño de bañera.
- Ducha de mano anticalcárea de latón.
- Caño de bañera de 180 mm. Caudal: 3 bar - 16 l/m.
- Kit depósito opcional no incluido ref.: 20324501.

06216103

370,00

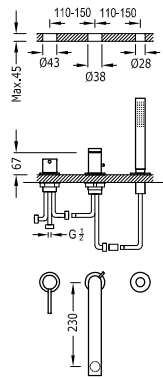

Grifo monomando para borde de bañera

- Inversor integrado en el caño de bañera.
- Ducha de mano anticalcárea de latón.
- Caño de bañera de 230 mm. Caudal: 3 bar - 16 l/m.
- Kit depósito opcional no incluido ref.: 20324501.

06216102

380,00

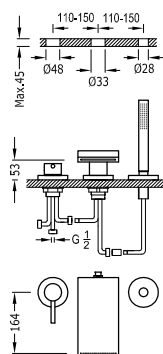

Grifo monomando para borde de bañera

- Inversor integrado en el caño de bañera.
- Ducha de mano anticalcárea de latón.
- Caño de bañera con salida del agua en cascada. Caudal: 3 bar - 17 l/m.
- Kit depósito opcional no incluido ref.: 162245.

162161

812,00



DEPÓSITOS

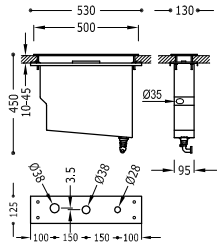

Depósito para grifería de borde de bañera

20224501

395,00

Fácil montaje superior. Sin registros. Para ref.: 20216104, 20216102, 20216103, 20216101, 20266102, 20266101.

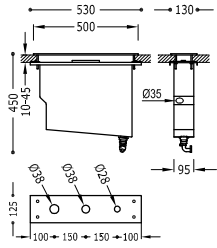

Depósito para grifería de borde de bañera

20024501

395,00

Fácil montaje superior. Sin registros. Para ref.: 00616106, 00616105, 0616104, 00616103, 20516103, 20516101, 21116101, 21116103.

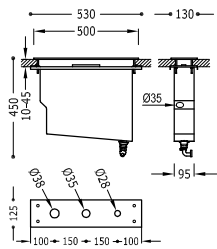

Depósito para grifería de borde de bañera

106245

395,00

Fácil montaje superior. Sin registros. Para ref.: 10716102, 10616102.

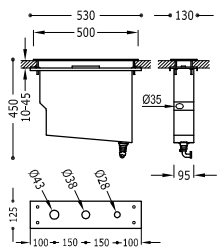

Depósito para grifería de borde de bañera

20324501

395,00

Fácil montaje superior. Sin registros. Para ref.: 06216103, 06216102, 20016203, 20016201, 08116104, 08116103, 20316102, 20316101.

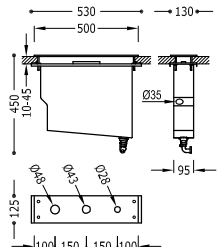

Depósito para grifería de borde de bañera

162245

395,00

Fácil montaje superior. Sin registros. Para ref.: 06116101, 162161, 26115001, 26215001.

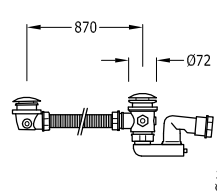

Válvula de desagüe Click-Clack para bañera con rebosadero y toma de drenaje

134445

95,00

Con toma de drenaje de agua para kit de depósito. Tapón Ø 72 mm.































COMPLEMENTOS DE DUCHA



Rociadores empotrados a techo	362
Rociadores a techo	366
Rociadores a pared	368
Rociadores y brazos	372
Duchas de mano	381
Flexos	387
Barras deslizantes	390
Kits de ducha	399
Soportes orientables	404
Soportes con toma a pared	405
Codo adaptador a pared	407
Jets	408

















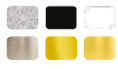



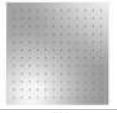

COMPLEMENTOS DE DUCHA

































Referencia	Página	Acabados disponibles	Empotrado a techo	A pared	A techo	Material de fabricación	Dimensiones	Salidas de agua	l/min				
								   					
 29997001	362		✓			 INOX	500x650	2	18,5	16			
 29997201	362		✓			 INOX	500x650	✓	2	18,5	16		
 29997101	362		✓			 INOX	500x650	3	18,5	16	8		
 29996201	362		✓			 INOX	500x500	✓	1	14			
 29995501	363		✓			 INOX	500x500	2	20	16			
 134951	363		✓			 INOX	500x500	1	24				
 13495102	363		✓			 INOX	405x405	2	15			-	
 13495101	363		✓			 INOX	405x405	1	15				
 29951607	364		✓			 INOX	420x420	1	20				
 29995301	364		✓			 INOX	380x380	1	20				
 134944	364		✓			 INOX	380x380	1	20				
 134714	364		✓				330x330	1	11				

Referencia	Página	Acabados disponibles	Empotrado a techo			Material de fabricación	Dimensiones	Salidas de agua	l/min				
			A pared	A techo									
 29995801	365		✓			INOX	Ø600	✓	2	20		8	
 134950	365		✓			INOX	Ø500		1	24			
 13495002	365		✓			INOX	Ø405		2	15			-
 13495001	365		✓			INOX	Ø405		1	15			
 134940	366		✓			INOX	Ø380		1	20			
 134715	366		✓				Ø330		1	11			
 29990301	368			✓		INOX	280x550		2	12	14		
 29990302	368			✓		INOX	210x550		1	12,5			
 29990303	368			✓		INOX	160x550		1	12,5			
 29990308	368			✓		INOX	280x550		2	12	14		
 29990307	369			✓		INOX	210x550		1	12,5			
 29990306	369			✓		INOX	160x550		1	12,5			













































COMPLEMENTOS DE DUCHA

Referencia	Página	Acabados disponibles	Empotrado a techo	A pared	A techo	Material de fabricación	Dimensiones	Salidas de agua	l/min				
													
 29990304	369			✓		INOX	154x200	1				16	
 29963203	372			✓	✓	INOX	450x315	1	14				
 134315008	372			✓	✓	INOX	400x250	1	16				
 29963202	372			✓	✓	INOX	320x220	1	12				
 134315007	372			✓	✓	INOX	300x200	1	12				
 134315014	372			✓	✓	INOX	400x400	1	15				
 134315012	373			✓	✓	INOX	300x300	1	12				
 134315006 134315004 134315002	373 374			✓	✓	INOX	300x300 250x250 200x200	1	12				
 13413830	373			✓	✓	INOX	300x300	1	11				
 134315011	373			✓	✓	INOX	250x250	1	12				
 13413826	374			✓	✓	ABS	250x250	1	11				

Referencia	Página	Acabados disponibles	Empotrado a techo			Material de fabricación	Dimensiones	Salidas de agua	l/min				
			A pared	A techo									
 29943801	374			✓	✓	 ABS	242x242	1	12				
 29963206	374			✓	✓	 ABS	220x220	1	15				
 134315015	374			✓	✓	 INOX	Ø400	1	15				
 29933703	375			✓	✓	 ABS	Ø310	1	11				
 134315010	375			✓	✓	 INOX	Ø300	1	12				
 134315005 134315003	375			✓	✓	 INOX	Ø300 Ø250	1	12				
 13413730	375			✓	✓	 ABS	Ø300	1	11				
 134315009	376			✓	✓	 INOX	Ø250	1	12				
 13413726	376			✓	✓	 ABS	Ø250	1	11				
 13431513	376			✓	✓	 ABS	Ø225	1	12				
 134315001	376			✓	✓	 INOX	Ø200	1	12				



COMPLEMENTOS DE DUCHA

	Referencia	Página	Acabados disponibles	Material de fabricación	Dimensiones	Número de funciones								l/min
	20263901	381				1	9,5							
	29963108	381				1	12							
	00663901	381				1	9,5							
	03463901	381				1	13							
	03411601	381				1	9,5							
	913412380	382				1	12							
	29974901	382			Ø110	5	10	12,5	12	12,5	10			
	29974904	382			Ø130	3	7	8	5					
	29974905	383			Ø110	3	8,8	9,6	8,8					
	29963115	382			Ø110	5	17	17	11	17	10			
	29963112	383			Ø110	3	8,5							8,5
	29963113	383			96x110	3	8,5							8,5

Referencia	Página	Acabados disponibles	Material de fabricación	Dimensiones	Número de funciones	l/min							
													
 29974906	383			107x107	3	8,2	8,6	8,1					
 29963111	383			120x120	3	10	14	9					
 134612	384			80x80	1	15							
 29963109	384			Ø78	1	10							
 29963110	384			Ø100	1	16							
 29963114	384			Ø100	3	14	14	10					
 29963105	384			Ø110	1	10							
 29963106	385			Ø110	5	10	10	8,5		8,5	9,5		
 134748	385			Ø100	5	16	16,5	15,5	16	11			
 29974802	385			Ø100	1	9,5							
 9134725	385			Ø77	1	7,5							
 134617	385			Ø80	1	15,5							
 134627	386			Ø80	2	15				7			





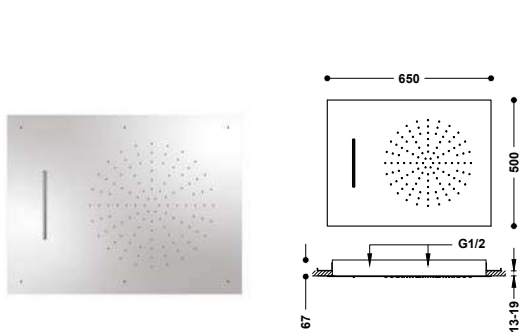



ROCIADORES EMPOTRADOS A TECHO



Rociador de ducha empotrado a techo

Con 2 tipos de chorro (lluvia/cascada). Alimentación mediante 2 vías de agua independientes. Dimensiones: 500x650 mm. Material: Acero inoxidable. Boquillas anticalcáreas.

-  29997001 **1.400,00**
-  29997001NM **2.170,00**
-  29997001BM **2.170,00**
-  29997001AC **2.170,00**
-  29997001OR **2.800,00**
-  29997001OM **2.800,00**

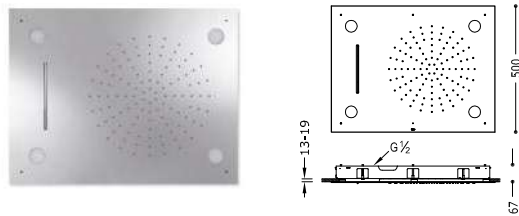
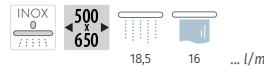

Rociador de ducha empotrado a techo con Cromoterapia

Con 2 tipos de chorro (lluvia/cascada). Alimentación mediante 2 vías de agua independientes. Dimensiones: 500x650 mm. Material: Acero inoxidable. Boquillas anticalcáreas. Las luces LED se activan con un interruptor (no incluido).

-  29997201 **2.400,00**

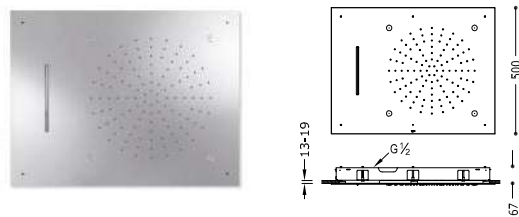

Rociador de ducha empotrado a techo

Con 3 tipos de chorro (lluvia/cascada/micro drop). Alimentación mediante 3 vías de agua independientes. Dimensiones: 500x650 mm. Material: Acero inoxidable. Boquillas anticalcáreas.

-  29997101 **1.500,00**

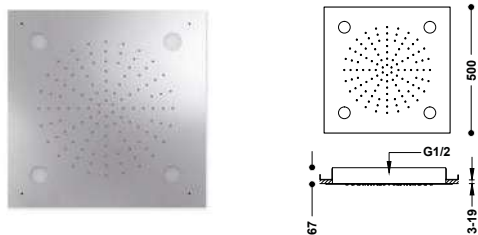
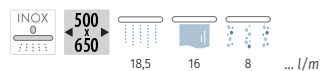

Rociador de ducha empotrado a techo con Cromoterapia

Dimensiones: 500x500 mm. Material: Acero inoxidable. Boquillas anticalcáreas. Las luces LED se activan automáticamente o con un interruptor (no incluido).



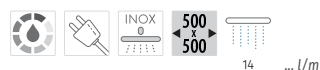

-  29996201 **1.350,00**

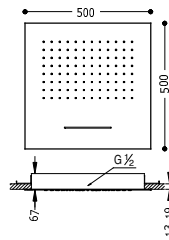

Rociador de ducha empotrado a techo

Con 2 tipos de chorro (lluvia/cascada). Alimentación mediante 2 vías de agua independientes. Dimensiones: 500x500 mm. Material: Acero inoxidable. Boquillas anticalcáreas.







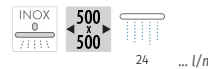
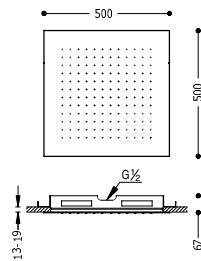
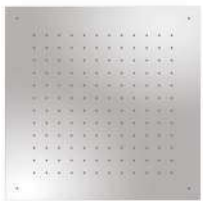

-  29995501 **1.100,00**
-  29995501NM **1.705,00**
-  29995501BM **1.705,00**
-  29995501AC **1.705,00**

Rociador de ducha empotrado a techo

Dimensiones: 500x500 mm. Material: Acero inoxidable. Boquillas anticalcáreas.





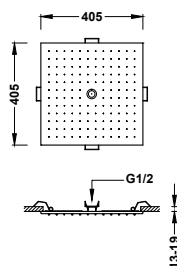
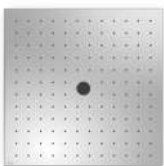

-  134951 **995,00**
-  134951NM **1.542,00**
-  134951BM **1.542,00**
-  134951AC **1.542,00**
-  134951OR **1.990,00**
-  134951OM **1.990,00**

Rociador de ducha empotrado a techo

Con 2 tipos de chorro (lluvia/free flow). Alimentación mediante 2 vías de agua independientes. Dimensiones: 405x405 mm. Material: Acero inoxidable. Boquillas anticalcáreas.



-  13495102 **870,00**
-  13495102NM **1.349,00**
-  13495102BM **1.349,00**
-  13495102AC **1.349,00**
-  13495102KM **1.349,00**
-  13495102KMB **1.349,00**
-  13495102OR **1.740,00**
-  13495102OM **1.740,00**
-  13495102OP **1.740,00**
-  13495102OPM **1.740,00**

Rociador de ducha empotrado a techo

Dimensiones: 405x405 mm. Material: Acero inoxidable. Boquillas anticalcáreas.

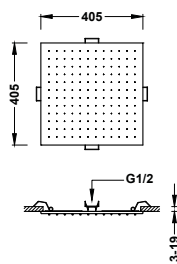
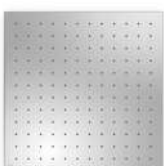

-  13495101 **800,00**
-  13495101NM **1.240,00**
-  13495101BM **1.240,00**
-  13495101AC **1.240,00**
-  13495101KM **1.240,00**
-  13495101KMB **1.240,00**
-  13495101OR **1.600,00**
-  13495101OM **1.600,00**
-  13495101OP **1.600,00**
-  13495101OPM **1.600,00**



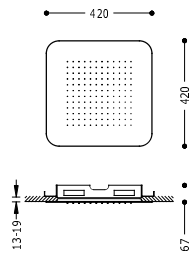

Rociador de ducha empotrado a techo

Dimensiones: 420x420 mm. Material: Acero inoxidable.
Boquillas anticalcáreas.

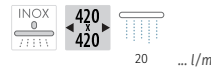

- 29951607 **895,00**
- 29951607NM **1.387,00**
- 29951607BM **1.387,00**
- 29951607AC **1.387,00**
- 29951607OR **1.790,00**
- 29951607OM **1.790,00**

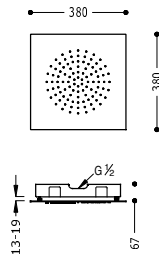

Rociador de ducha empotrado a techo

Dimensiones: 380x380 mm. Material: Acero inoxidable.
Boquillas anticalcáreas.

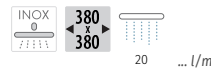

- 29995301 **770,00**
- 29995301NM **1.194,00**
- 29995301BM **1.194,00**
- 29995301AC **1.194,00**
- 29995301OR **1.540,00**
- 29995301OM **1.540,00**

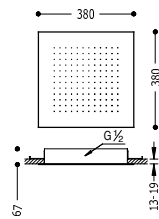

Rociador de ducha empotrado a techo

Dimensiones: 380x380 mm. Material: Acero inoxidable.
Boquillas anticalcáreas.

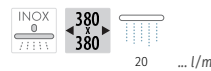

- 134944 **795,00**
- 134944NM **1.232,00**
- 134944BM **1.232,00**
- 134944AC **1.232,00**
- 134944OR **1.590,00**
- 134944OM **1.590,00**

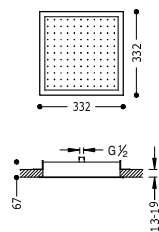

Rociador de ducha empotrado a techo

Dimensiones: 332x332 mm. Material latón. Boquillas anticalcáreas.

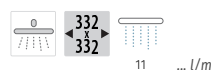

- 134714 **520,00**

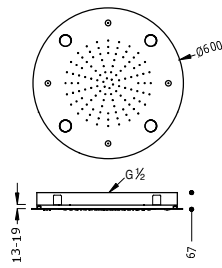

Rociador de ducha empotrado a techo con Cromoterapia

Con 2 tipos de chorro (lluvia/Micro drop). Alimentación mediante 2 vías de agua independientes. Dimensiones: Ø 600 mm. Material: Acero inoxidable. Boquillas anticálcáreas. Las luces LED se activan con un interruptor (no incluido).

29995801 **2.400,00**

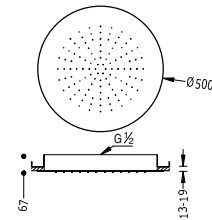

Rociador de ducha empotrado a techo

Dimensiones: Ø 500 mm. Material: Acero inoxidable. Boquillas anticálcáreas.

134950 **995,00**

- 134950NM **1.542,00**
- 134950BM **1.542,00**
- 134950AC **1.542,00**
- 134950OR **1.990,00**
- 134950OM **1.990,00**

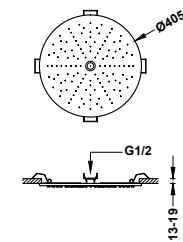
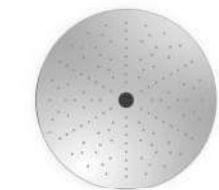
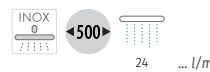

Rociador de ducha empotrado a techo

Con 2 tipos de chorro (lluvia/free flow). Alimentación mediante 2 vías de agua independientes. Dimensiones: Ø 405 mm. Material: Acero inoxidable. Boquillas anticálcáreas.

13495002 **820,00**

- 13495002NM **1.271,00**
- 13495002BM **1.271,00**
- 13495002AC **1.271,00**
- 13495002KM **1.271,00**
- 13495002KMB **1.271,00**
- 13495002OR **1.640,00**
- 13495002OM **1.640,00**
- 13495002OP **1.640,00**
- 13495002OPM **1.640,00**

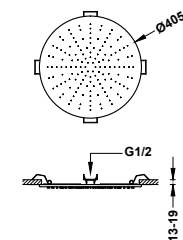
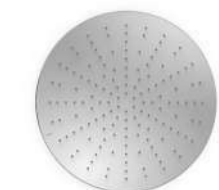

Rociador de ducha empotrado a techo

Dimensiones: Ø 405 mm. Material: Acero inoxidable. Boquillas anticálcáreas.

13495001 **750,00**

- 13495001NM **1.163,00**
- 13495001BM **1.163,00**
- 13495001AC **1.163,00**
- 13495001KM **1.163,00**
- 13495001KMB **1.163,00**
- 13495001OR **1.500,00**
- 13495001OM **1.500,00**
- 13495001OP **1.500,00**
- 13495001OPM **1.500,00**



Rociador de ducha empotrado a techo

Dimensiones: Ø 380 mm. Material: Acero inoxidable.
Boquillas anticalcáreas.

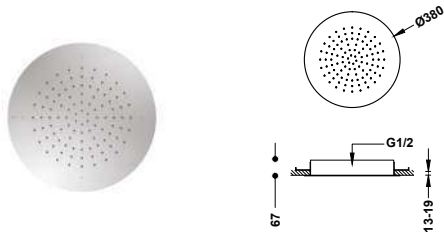

- 134940 **795,00**
- 134940NM **1.232,00**
- 134940BM **1.232,00**
- 134940AC **1.232,00**
- 134940KM **1.232,00**
- 134940KMB **1.232,00**
- 134940OR **1.590,00**
- 134940OM **1.590,00**
- 134940OP **1.590,00**
- 134940OPM **1.590,00**

Rociador de ducha empotrado a techo

Dimensiones: Ø 332 mm. Material latón. Boquillas anticalcáreas.

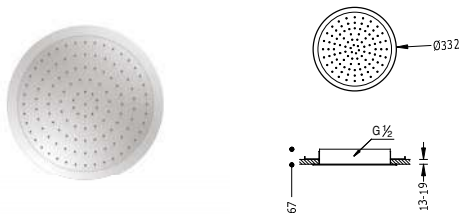

- 134715 **520,00**

ROCIADORES A TECHO

Brazo a techo con rociador de ducha orientable

Brazo a techo: 157 mm. Rociador de ducha orientable: 450x315 mm.
Material: Latón.

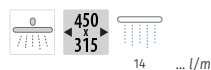

- 03443203 **415,00**

Brazo a techo con rociador de ducha orientable

Brazo a techo: 141 mm. Rociador de ducha orientable: 300x200 mm.
Material: Acero inoxidable.

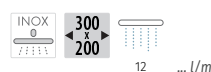

- 03443202 **265,00**

Brazo a techo con rociador de ducha orientable

03483102

335,00

Brazo a techo: 157 mm. Rociador de ducha orientable: 300x300 mm.
Material: Latón.

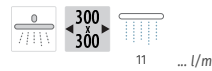
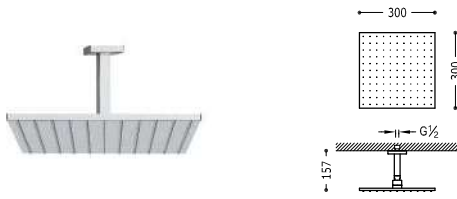

Brazo a techo con rociador de ducha orientable

03412102

155,00

Brazo a techo: 166 mm. Rociador de ducha orientable: 250x250 mm.

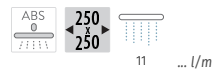
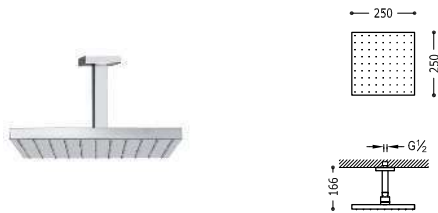

Brazo a techo con rociador de ducha orientable

134331

173,00

Brazo a techo: 153 mm. Rociador de ducha orientable: Ø 300 mm.
Material: Acero inoxidable.

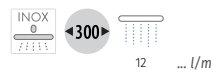
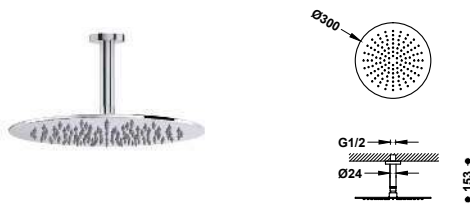

Brazo a techo con rociador de ducha orientable

134221

138,00

Brazo a techo: 155 mm. Rociador de ducha orientable: Ø 250 mm.

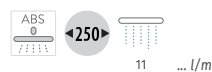





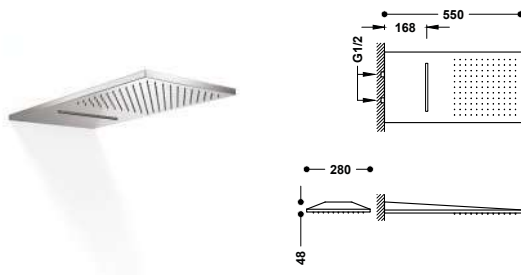

ROCIADORES A PARED

Rociador de ducha a pared

Con 2 tipos de chorro (lluvia/cascada). Alimentación mediante 2 vías de agua independientes. Dimensiones: 280x550 mm. Material: Acero inoxidable. Boquillas anticálcáreas.







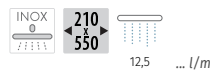
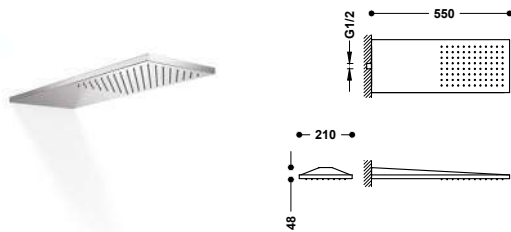

-  29990301 **740,00**
-  29990301NM **1.147,00**
-  29990301BM **1.147,00**
-  29990301AC **1.147,00**
-  29990301OR **1.480,00**
-  29990301OM **1.480,00**

Rociador de ducha a pared

Dimensiones: 210x550 mm. Material: Acero inoxidable. Boquillas anticálcáreas.



-  29990302 **540,00**
-  29990302NM **837,00**
-  29990302BM **837,00**
-  29990302AC **837,00**
-  29990302OR **1.080,00**
-  29990302OM **1.080,00**

Rociador de ducha a pared

Dimensiones: 160x550 mm. Material: Acero inoxidable. Boquillas anticálcáreas.

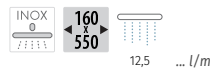
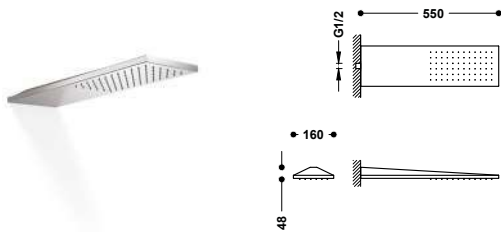



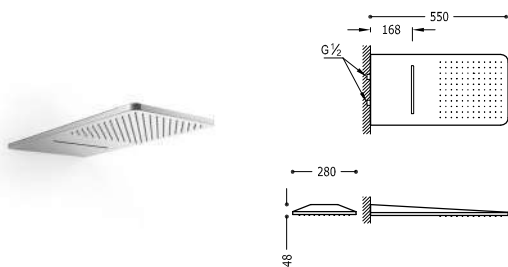

-  29990303 **440,00**
-  29990303NM **682,00**
-  29990303BM **682,00**
-  29990303AC **682,00**
-  29990303KM **682,00**
-  29990303KMB **682,00**
-  29990303OR **880,00**
-  29990303OM **880,00**
-  29990303OP **880,00**
-  29990303OPM **880,00**

Rociador de ducha a pared

Con 2 tipos de chorro (lluvia/cascada). Alimentación mediante 2 vías de agua independientes. Dimensiones: 280x550 mm. Material: Acero inoxidable. Boquillas anticálcáreas.



-  29990308 **800,00**
-  29990308NM **1.240,00**
-  29990308BM **1.240,00**
-  29990308AC **1.240,00**

Rociador de ducha a pared





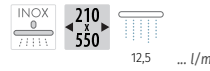
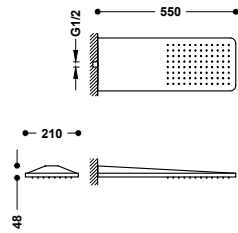

Dimensiones: 210x550 mm. Material: Acero inoxidable.
Boquillas anticalcáreas.

-  29990307 **600,00**
-  29990307NM **930,00**
-  29990307BM **930,00**
-  29990307AC **930,00**
-  29990307KM **930,00**
-  29990307KMB **930,00**
-  29990307OR **1.200,00**
-  29990307OM **1.200,00**
-  29990307OP **1.200,00**
-  29990307OPM **1.200,00**



Rociador de ducha a pared





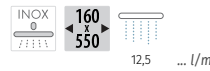
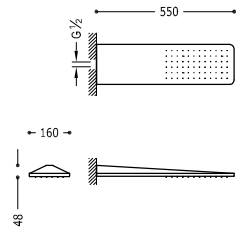

Dimensiones: 160x550 mm. Material: Acero inoxidable.
Boquillas anticalcáreas.

-  29990306 **500,00**
-  29990306NM **775,00**
-  29990306BM **775,00**
-  29990306AC **775,00**
-  29990306OR **1.000,00**
-  29990306OM **1.000,00**



Rociador de ducha a pared

Con salida del agua en cascada. Material: Acero inoxidable.
Dimensiones: 154x200 mm.

-  29990304 **440,00**
-  29990304NM **682,00**
-  29990304BM **682,00**
-  29990304AC **682,00**
-  29990304OR **880,00**
-  29990304OM **880,00**

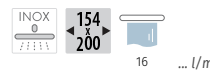
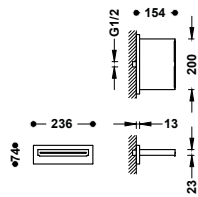

Brazo a pared con rociador de ducha orientable

Brazo a pared: 400 mm. Rociador de ducha orientable: 300x200 mm.
Material: Acero inoxidable.

-  29953202 **288,00**

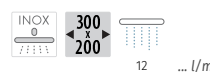
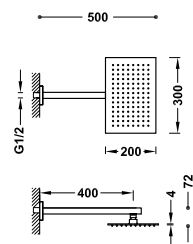

Brazo a pared con rociador de ducha orientable

134433

255,00

Brazo a pared: 400 mm. Rociador de ducha orientable: 300x300 mm.
Material: Acero inoxidable.

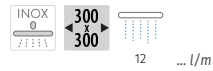
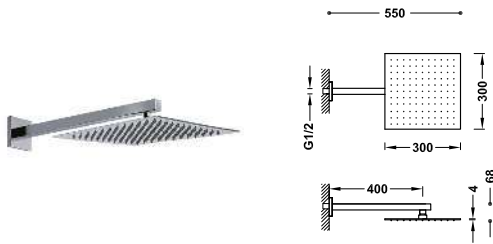

Brazo a pared con rociador de ducha orientable

134233

168,00

Brazo a pared: 400 mm. Rociador de ducha orientable: 250x250 mm.

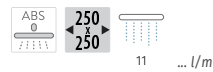
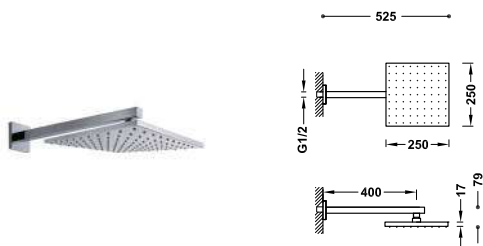

Brazo a pared con rociador de ducha orientable

03443101

343,00

Brazo a pared: 400 mm. Rociador de ducha orientable: 300x300 mm.
Material: Latón.

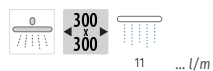
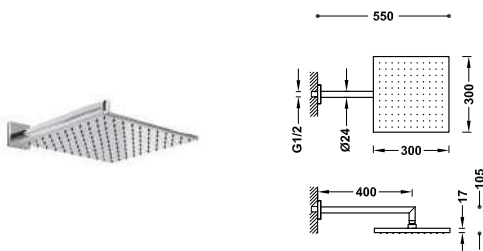

Brazo a pared con rociador de ducha orientable

03423101

163,00

Brazo a pared: 400 mm. Rociador de ducha orientable: 250x250 mm.

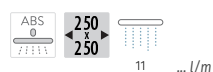
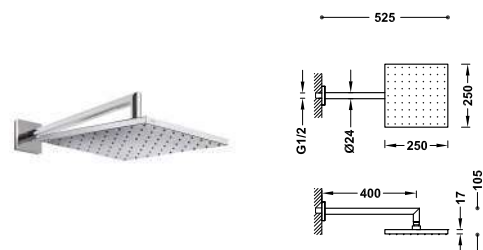

Brazo a pared con rociador de ducha orientable

134432

215,00

Brazo a pared: 400 mm. Rociador de ducha orientable: Ø 300 mm.
Material: Acero inoxidable.

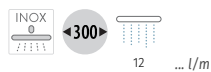
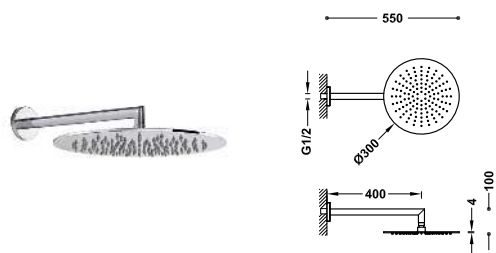

Brazo a pared con rociador de ducha orientable

134232

155,00

Brazo a pared: 400 mm. Rociador de ducha orientable: Ø 250 mm.

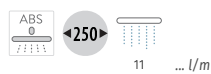
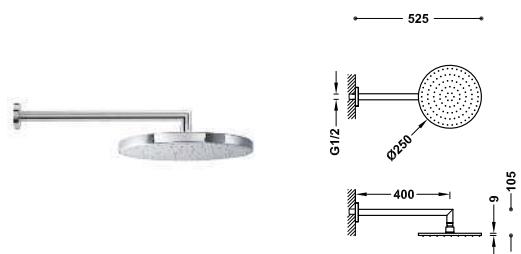



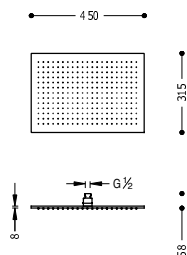
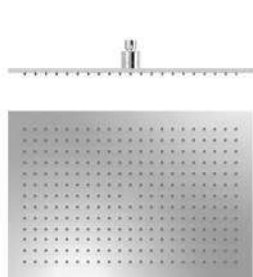



ROCIADORES Y BRAZOS

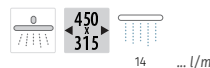

Rociador de ducha

Dimensiones: 450x315 mm. Rótula orientable. Material: Latón. Boquillas anticalcáreas.





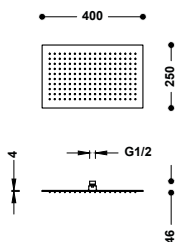



-  29963203 **350,00**
-  29963203NM **543,00**
-  29963203BM **543,00**
-  29963203AC **543,00**
-  29963203OR **700,00**
-  29963203OM **700,00**

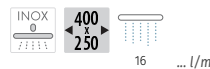

Rociador de ducha

Extrafino: 4 mm. Dimensiones: 400x250 mm. Rótula orientable. Material: Acero inoxidable. Boquillas anticalcáreas.





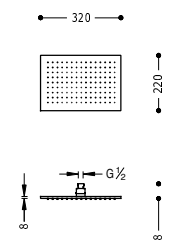
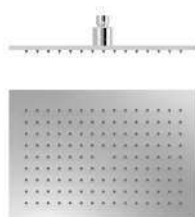



-  134315008 **250,00**
-  134315008NM **388,00**
-  134315008BM **388,00**
-  134315008AC **388,00**
-  134315008OR **500,00**
-  134315008OM **500,00**



Rociador de ducha

Dimensiones: 320x220 mm. Rótula orientable. Material: Latón. Boquillas anticalcáreas.



-  29963202 **300,00**
-  29963202NM **465,00**
-  29963202BM **465,00**
-  29963202AC **465,00**
-  29963202OR **600,00**
-  29963202OM **600,00**

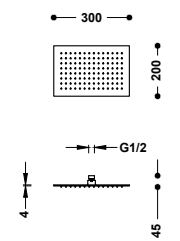
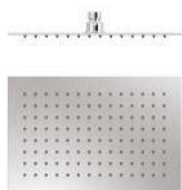

Rociador de ducha

Extrafino: 4 mm. Dimensiones: 300x200 mm. Rótula orientable. Material: Acero inoxidable. Boquillas anticalcáreas.

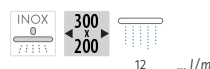

-  134315007 **200,00**
-  134315007NM **310,00**
-  134315007BM **310,00**
-  134315007AC **310,00**
-  134315007KMB **310,00** 
-  134315007OR **400,00**
-  134315007OM **400,00**
-  134315007OP **400,00** 
-  134315007OPM **400,00** 

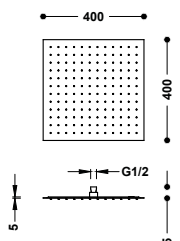
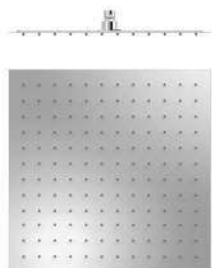

Rociador de ducha

Dimensiones: 400x400 mm. Rótula orientable. Material: Acero inoxidable. Incorpora una válvula de alivio de presión de membrana. Boquillas anticalcáreas.



-  134315014 **215,00**

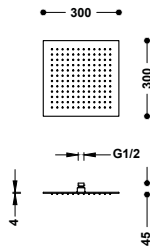
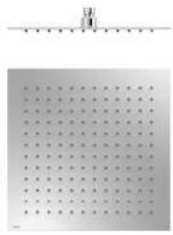

Rociador de ducha

Extrafino: 4 mm. Dimensiones: 300x300 mm. Rótula orientable. Material: Acero inoxidable. Boquillas anticalcáreas.

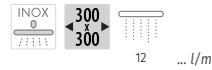

- 134315012 **167,00**
- 134315012NM **259,00**
- 134315012BM **259,00**
- 134315012AC **259,00**
- 134315012KM **259,00**
- 134315012KMB **259,00**
- 134315012OR **334,00**
- 134315012OM **334,00**
- 134315012OP **334,00**
- 134315012OPM **334,00** N

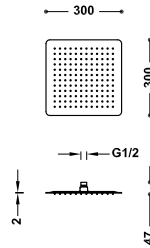

Rociador de ducha

Dimensiones: 300x300 mm. Rótula orientable. Material: Acero inoxidable. Boquillas anticalcáreas.

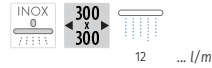

- 134315006 **145,00**

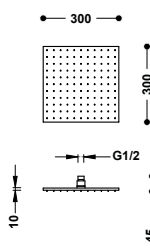
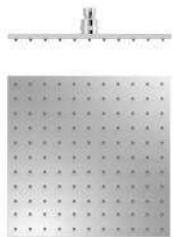

Rociador de ducha

Dimensiones: 300x300 mm. Rótula orientable. Material: Latón. Boquillas anticalcáreas.

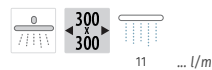

- 13413830 **260,00**
- 13413830NM **403,00**
- 13413830BM **403,00**
- 13413830AC **403,00**
- 13413830KM **403,00**
- 13413830KMB **403,00**
- 13413830OR **520,00**
- 13413830OM **520,00**
- 13413830OP **520,00**
- 13413830OPM **520,00**

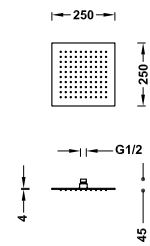

Rociador de ducha

Extrafino: 4 mm. Dimensiones: 250x250 mm. Rótula orientable. Material: Acero inoxidable. Boquillas anticalcáreas.

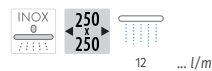

- 134315011 **142,00**

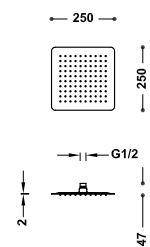

Rociador de ducha

Dimensiones: 250x250 mm. Rótula orientable. Material: Acero inoxidable. Boquillas anticalcáreas.

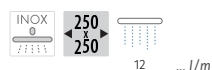

- 134315004 **120,00**

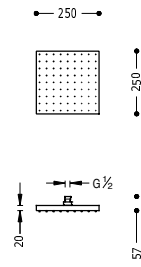
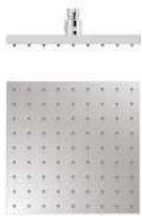

Rociador de ducha

Dimensiones: 250x250 mm. Rótula orientable. Boquillas anticalcáreas.

13413826

80,00

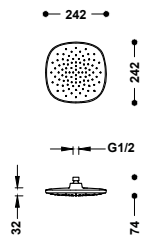
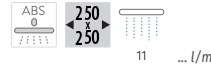

Rociador de ducha

Dimensiones: 242x242 mm. Rótula orientable. Boquillas anticalcáreas.

29943801

52,00

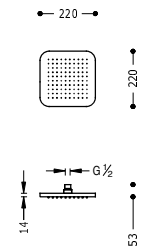
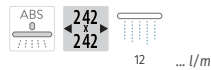

Rociador de ducha

Dimensiones: 220x220 mm. Rótula orientable. Boquillas anticalcáreas.

29963206

135,00

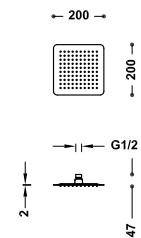
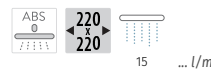

Rociador de ducha

Dimensiones: 200x200 mm. Rótula orientable. Material: Acero inoxidable. Boquillas anticalcáreas.

134315002

75,00

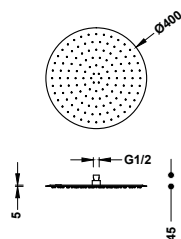
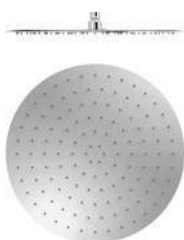
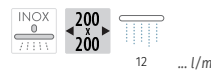

Rociador de ducha

Dimensiones: Ø 400 mm. Rótula orientable. Material: Acero inoxidable. Incorpora una válvula de alivio de presión de membrana. Boquillas anticalcáreas.

134315015

167,00



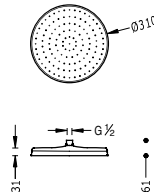
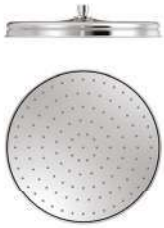

Rociador de ducha

Dimensiones: Ø 310 mm. Rótula orientable. Material: Latón.
Boquillas anticálcarea.

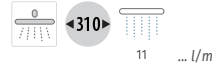

- 29933703 **260,00**
- 29933703AC **403,00**
- 29933703OR **520,00**
- 29933703LV **364,00**
- 29933703LM **364,00**

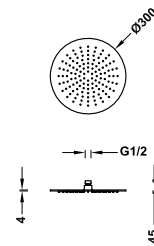
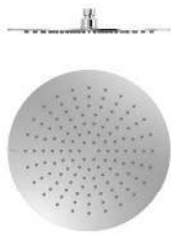

Rociador de ducha

Extrafino: 4 mm. Dimensiones: Ø 300 mm. Rótula orientable. Material: Acero inoxidable. Boquillas anticálcarea.

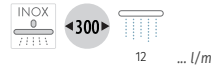

- 134315010 **140,00**
- 134315010NM **217,00**
- 134315010BM **217,00**
- 134315010AC **217,00**
- 134315010KM **217,00**
- 134315010KMB **217,00**
- 134315010OR **280,00**
- 134315010OM **280,00**
- 134315010OP **280,00**
- 134315010OPM **280,00**

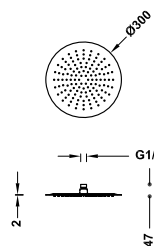

Rociador de ducha

Dimensiones: Ø 300 mm. Rótula orientable. Material: Acero inoxidable. Boquillas anticálcarea.

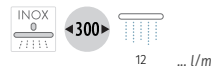

- 134315005 **125,00**

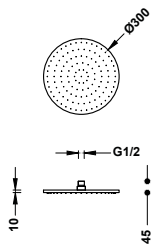

Rociador de ducha

Dimensiones: Ø 300 mm. Rótula orientable. Material: Latón. Boquillas anticálcarea.

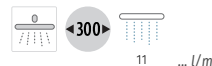

- 13413730 **248,00**
- 13413730NM **384,00**
- 13413730BM **384,00**
- 13413730AC **384,00**
- 13413730KM **384,00**
- 13413730KMB **384,00**
- 13413730OR **496,00**
- 13413730OM **496,00**
- 13413730OP **496,00**
- 13413730OPM **496,00**

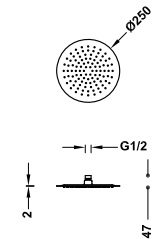

Rociador de ducha

Dimensiones: Ø 250 mm. Rótula orientable. Material: Acero inoxidable. Boquillas anticálcarea.



- 134315003 **100,00**

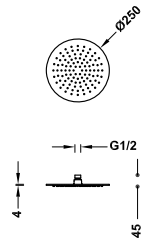

Rociador de ducha

Extrafino: 4 mm. Dimensiones: Ø 250 mm. Rótula orientable. Material: Acero inoxidable. Boquillas anticalcáreas.

134315009

95,00

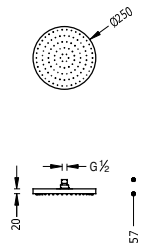
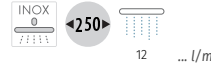

Rociador de ducha

Dimensiones: Ø 250 mm. Rótula orientable. Boquillas anticalcáreas.

13413726

80,00

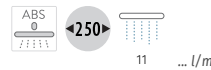

BOQUILLAS ANTICALCÁREAS AUTOLIMPIABLES

Cada vez que se cierra el grifo, unas pequeñas púas tapan las boquillas para limpiarlas y dejarlas libres cuando vuelva a salir el agua.

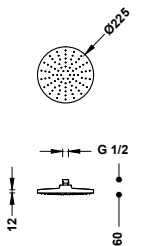

Rociador de ducha

Dimensiones: Ø 225 mm. Rótula orientable. Boquillas anticalcáreas autolimpiables.

13431513

45,00

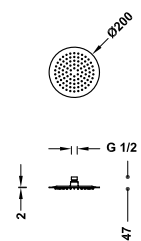
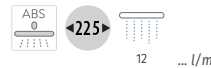

Rociador de ducha

Dimensiones: Ø 200 mm. Rótula orientable. Material: Acero inoxidable. Boquillas anticalcáreas.

134315001

55,00

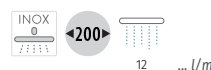

Brazo a pared
Para rociador de ducha. Longitud: 300 mm.

13462101 **62,00**



Brazo a pared
Para rociador de ducha. Longitud: 400 mm.

13413940 **88,00**



- 13413940NM **136,00**
- 13413940BM **136,00**
- 13413940AC **136,00**
- 13413940OR **176,00**
- 13413940OM **176,00**



Brazo a pared
Para rociador de ducha. Longitud: 400 mm.

13462104 **75,00**

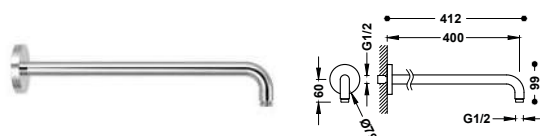

- 13462104NM **116,00**
- 13462104BM **116,00**
- 13462104AC **116,00**
- 13462104KM **116,00**
- 13462104KMB **116,00**
- 13462104OR **150,00**
- 13462104OM **150,00**
- 13462104OP **150,00**
- 13462104OPM **150,00**

Brazo a pared
Para rociador de ducha. Longitud: 390 mm.

13463302 **77,00**

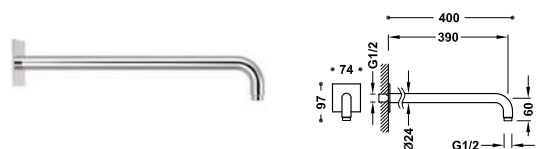

Brazo a pared
Para rociador de ducha. Longitud: 390 mm.

13463303 **75,00**

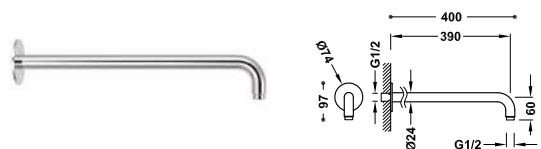

Brazo a pared
Para rociador de ducha. Longitud: 390 mm.

13463301 **77,00**

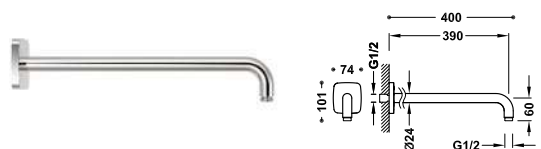

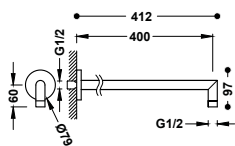

Brazo a pared

Para rociador de ducha. Longitud: 400 mm.

	16118740	75,00
	16118740NM	116,00
	16118740BM	116,00
	16118740AC	116,00
	16118740KMB	116,00 N
	16118740OR	150,00
	16118740OM	150,00
	16118740OP	150,00 N
	16118740OPM	150,00 N

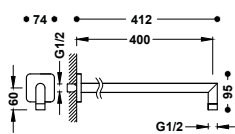

Brazo a pared

Para rociador de ducha. Longitud: 400 mm.

	29963902	83,00
	29963902NM	129,00
	29963902BM	129,00
	29963902AC	129,00
	29963902KMB	129,00 N
	29963902OR	166,00
	29963902OM	166,00
	29963902OP	166,00 N
	29963902OPM	166,00 N

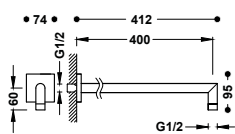

Brazo a pared

Para rociador de ducha. Longitud: 400 mm.

	06243201	83,00
	06243201NM	129,00
	06243201BM	129,00
	06243201AC	129,00
	06243201KM	129,00
	06243201KMB	129,00
	06243201OR	166,00
	06243201OM	166,00
	06243201OP	166,00
	06243201OPM	166,00

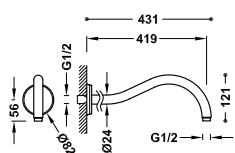

Brazo a pared

Para rociador de ducha. Longitud: 419 mm.

	29933701	82,00
	29933701AC	127,00
	29933701OR	164,00
	29933701LV	115,00
	29933701LM	115,00

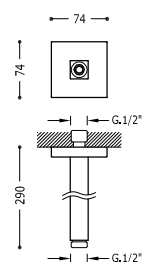

Brazo a techo

Para rociador de ducha. Longitud: 290 mm.

	13462202	75,00
	13462202NM	116,00
	13462202BM	116,00
	13462202AC	116,00
	13462202OR	150,00
	13462202OM	150,00

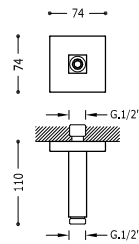

Brazo a techo

Para rociador de ducha. Longitud: 110 mm.

- 13452202 **65,00**
- 13452202NM **101,00**
- 13452202BM **101,00**
- 13452202AC **101,00**
- 13452202OR **130,00**
- 13452202OM **130,00**

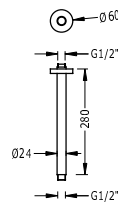

Brazo a techo

Para rociador de ducha. Longitud: 280 mm.

- 13462102 **58,00**
- 13462102NM **89,90**
- 13462102BM **89,90**
- 13462102AC **89,90**
- 13462102KMB **89,90** N
- 13462102OR **116,00**
- 13462102OM **116,00**
- 13462102OP **116,00** N
- 13462102OPM **116,00** N

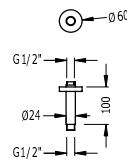

Brazo a techo

Para rociador de ducha. Longitud: 100 mm.

- 13452102 **48,00**
- 13452102NM **74,40**
- 13452102BM **74,40**
- 13452102AC **74,40**
- 13452102KM **74,40**
- 13452102KMB **74,40**
- 13452102OR **96,00**
- 13452102OM **96,00**
- 13452102OP **96,00**
- 13452102OPM **96,00** N

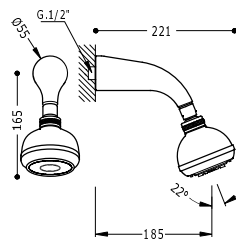

Brazo a pared con rociador de ducha orientable

Rociador de ducha orientable: Ø 93 mm. 3 tipos de chorro.

- 134818 **85,00**

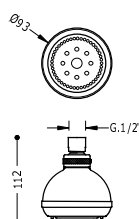

Rociador de ducha

Rótula orientable. Dimensiones: Ø 93 mm. 3 tipos de chorro.

- 913481810 **25,00**



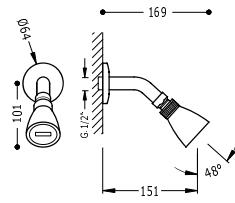

Brazo a pared con rociador de ducha orientable
Rociador de ducha orientable: Ø 54 mm.

134738

54,00

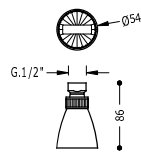

Rociador de ducha

Rótula orientable. Dimensiones: Ø 54 mm.

913473810

34,50

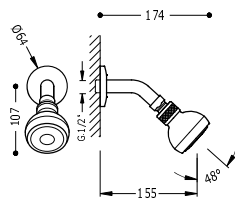

Brazo a pared con rociador de ducha orientable

Rociador de ducha orientable: Ø 70 mm. Boquillas anticalcáreas.

134808

37,70

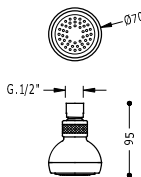

Rociador de ducha

Rótula orientable. Dimensiones: Ø 70 mm. Boquillas anticalcáreas.

913480810

18,20

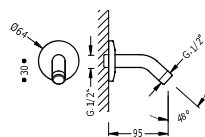

Brazo a pared para rociador de ducha

Para rociador de ducha. Longitud: 95 mm.

13473850

19,50

DUCHAS DE MANO

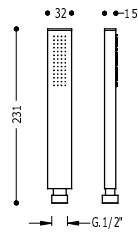

Ducha de mano
Material: Latón. Boquillas anticalcáreas.

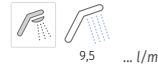

- 20263901 **48,00**
- 20263901NM **74,40**
- 20263901BM **74,40**
- 20263901AC **74,40**
- 20263901KM **74,40**
- 20263901KMB **74,40**
- 20263901OR **96,00**
- 20263901OM **96,00**
- 20263901OP **96,00**
- 20263901OPM **96,00**

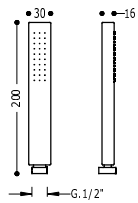

Ducha de mano
Boquillas anticalcáreas.

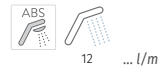

- 29963108 **20,00**

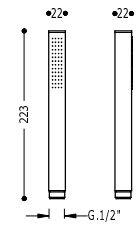

Ducha de mano
Material: Latón. Boquillas anticalcáreas.



- 00663901 **45,00**
- 00663901NM **69,75**
- 00663901BM **69,75**
- 00663901AC **69,75**
- 00663901KMB **69,75** N
- 00663901OR **90,00**
- 00663901OM **90,00**
- 00663901OP **90,00** N
- 00663901OPM **90,00** N

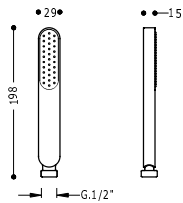

Ducha de mano
Boquillas anticalcáreas.



- 03463901 **38,00**
- 03463901NM **58,90**
- 03463901BM **58,90**
- 03463901AC **58,90**
- 03463901KMB **58,90** N
- 03463901OR **76,00** N
- 03463901OM **76,00** N
- 03463901OP **76,00** N
- 03463901OPM **76,00** N
- 03463901NE **58,90**
- 03463901BL **58,90**

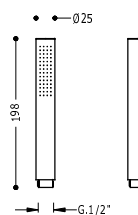

Ducha de mano
Material: Latón. Boquillas anticalcáreas.

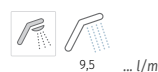

- 03411601 **40,00**
- 03411601NM **62,00**
- 03411601BM **62,00**
- 03411601AC **62,00**
- 03411601KM **62,00**
- 03411601KMB **62,00**
- 03411601OR **80,00**
- 03411601OM **80,00**
- 03411601OP **80,00**
- 03411601OPM **80,00**

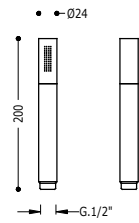

Ducha de mano
Material: Latón.

913412380

30,00

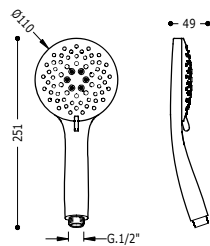
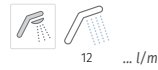

Ducha de mano

Con 5 tipos de chorro. Medida: Ø 110 mm. Boquillas anticalcáreas.

29974901

32,00

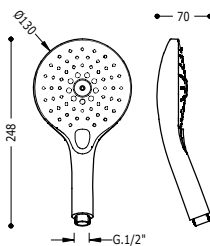
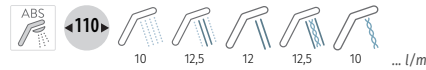

Ducha de mano

Con 3 tipos de chorro. Medida: Ø 130 mm. Boquillas anticalcáreas.

29974904

44,00



BOQUILLAS ANTICALCÁREAS AUTOLIMPIABLES

Al cambiar de función moviendo la palanca, las púas limpian cada boquilla para que no quede cal incrustada.

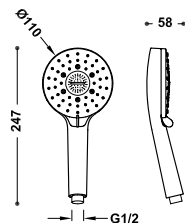
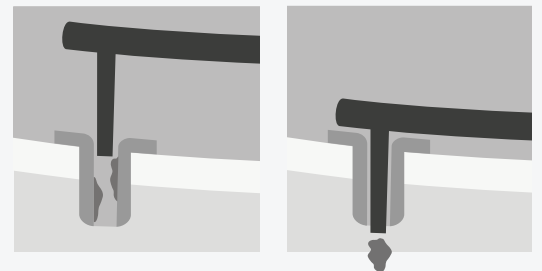

Ducha de mano

Dimensiones: Ø 110 mm. 5 tipos de chorro. Boquillas anticalcáreas autolimpiables.

29963115

24,00

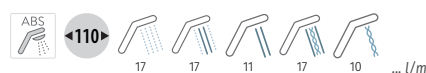

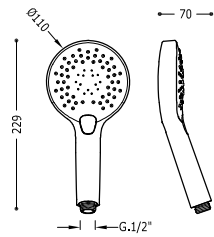

Ducha de mano

Con 3 tipos de chorro. Medida: Ø 110 mm. Boquillas anticalcáreas.

29974905

34,00

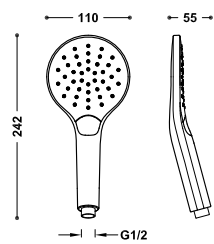
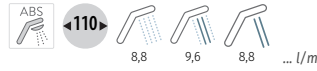

Ducha de mano ECO-DROP

Con 3 tipos de chorro. Medida: Ø 110 mm. Boquillas anticalcáreas.

29963112

40,00

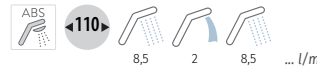

- 29963112NM 62,00
- 29963112BM 62,00
- 29963112AC 62,00
- 29963112KM 62,00
- 29963112KMB 62,00
- 29963112OR 80,00
- 29963112OM 80,00
- 29963112OP 80,00
- 29963112OPM 80,00

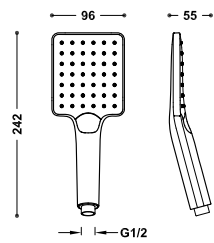

Ducha de mano ECO-DROP

Con 3 tipos de chorro. Medida: 96x110 mm. Boquillas anticalcáreas.

29963113

42,00

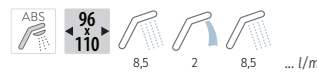

- 29963113NM 65,10
- 29963113BM 65,10
- 29963113AC 65,10
- 29963113KM 65,10
- 29963113KMB 65,10
- 29963113OR 84,00
- 29963113OM 84,00
- 29963113OP 84,00
- 29963113OPM 84,00

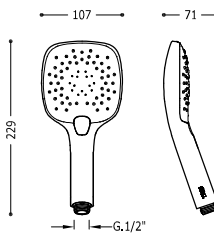

Ducha de mano

Con 3 tipos de chorro. Medida: 107x107 mm. Boquillas anticalcáreas.

29974906

38,00

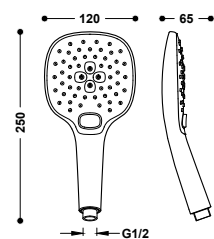
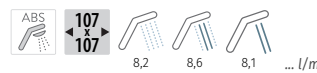

Ducha de mano

Dimensiones: 120x120 mm. 3 tipos de chorro. Boquillas anticalcáreas.

29963111

25,20

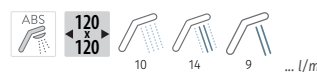

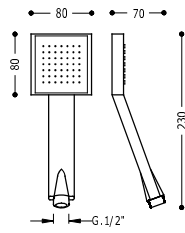

Ducha de mano
Medida: 80x80 mm. Boquillas anticalcáreas.

134612

17,60

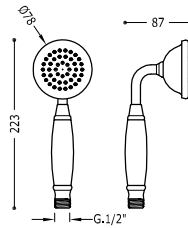
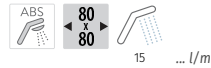

Ducha de mano
Mango cerámico. Dimensiones: Ø 78 mm. Material: Latón. Boquillas anticalcáreas.

29963109

56,00

- 29963109AC **86,80**
- 29963109OR **112,00**
- 29963109LV **78,40**
- 29963109LM **78,40**

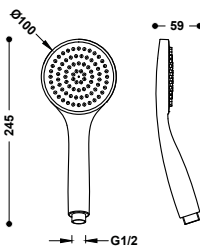

Ducha de mano
Dimensiones: Ø 100 mm. Boquillas anticalcáreas.

29963110

15,20

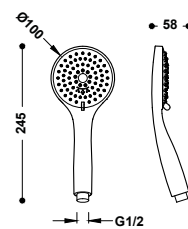

Ducha de mano
Dimensiones: Ø 100 mm. 3 tipos de chorro. Boquillas anticalcáreas.

29963114

15,30

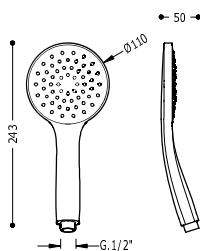
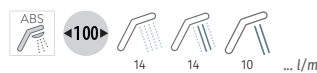

Ducha de mano
Dimensiones: Ø 110 mm. Boquillas anticalcáreas.

29963105

27,30



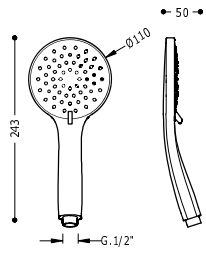

Ducha de mano

Dimensiones: Ø 110 mm. 5 tipos de chorro. Boquillas anticalcáreas.

29963106

24,50

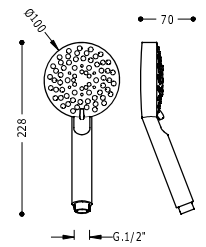
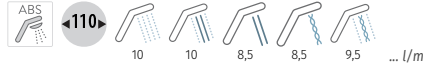

Ducha de mano

Dimensiones: Ø 100 mm. 5 tipos de chorro. Boquillas anticalcáreas.

134748

47,00

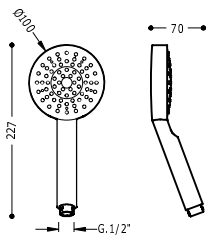
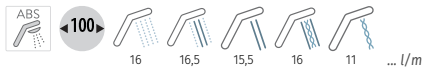

Ducha de mano

Dimensiones: Ø 100 mm.

29974802

29,00

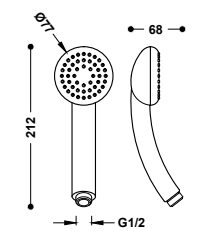

Ducha de mano

Dimensiones: Ø 77 mm. Boquillas anticalcáreas.

9134725

11,30

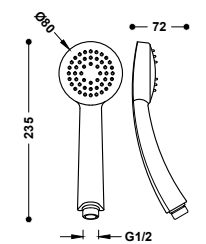
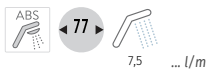

Ducha de mano

Dimensiones: Ø 80 mm. Boquillas anticalcáreas.

134617

14,50

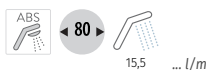

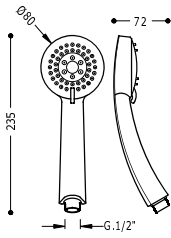

Ducha de mano

Dimensiones: Ø 80 mm. 2 tipos de chorro. Boquillas anticalcáreas.

134627

16,00

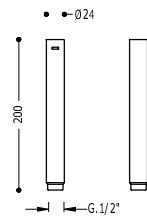
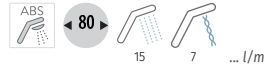

Ducha de mano para grifo de inodoro

Con record limitador: 5 l/min. Para ref.: 34122, 34123, 81122, 81123, 81222, 81223, 62122, 62123, 006123, 205222, 205223, 217123, 281123.

29912390

45,00

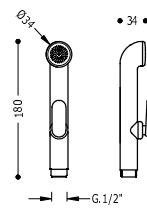

Ducha de mano con cierre para grifo de inodoro

Con record limitador: 8 l/min. Para ref.: 81113, 62113, 20311301.

29911351

15,30

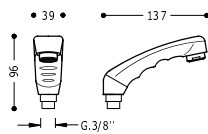

Ducha de mano para grifo de peluquería

9134450

19,00



FLEXOS

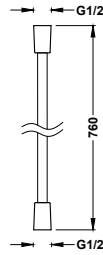

Flexo satinado

Long.: 0,76 m. Diámetro: Ø 14,5 mm. Giratorio antitorsión.

913460910

21,00

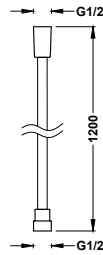

Flexo satinado

Long.: 1,20 m. Diámetro: Ø 14,5 mm. Giratorio antitorsión.

913460912

22,00

913460912NM **34,10**

913460912BM **34,10**

913460912AC **34,10**

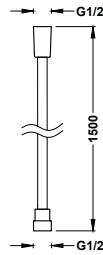

Flexo satinado

Long.: 1,50 m. Diámetro: Ø 14,5 mm. Giratorio antitorsión.

913460915

22,50

913460915NM **34,90**

913460915BM **34,90**

913460915AC **34,90**

913460915KM **34,90**

913460915KMB **34,90**

913460915OR **45,00**

913460915OM **45,00**

913460915OP **45,00**

913460915OPM **45,00**

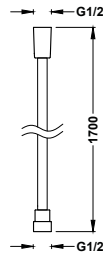

Flexo satinado

Long.: 1,70 m. Diámetro: Ø 14,5 mm. Giratorio antitorsión.

9134609

23,00

9134609NM **35,65**

9134609BM **35,65**

9134609AC **35,65**

9134609KM **35,65**

9134609KMB **35,65**

9134609OR **46,00**

9134609OM **46,00**

9134609OP **46,00**

9134609OPM **46,00**

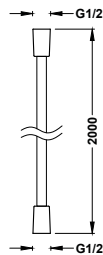

Flexo satinado

Long.: 2,00 m. Diámetro: Ø 14,5 mm. Giratorio antitorsión.

913460920

23,50

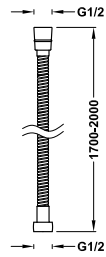

Flexo metálico extensible

Long: 1,70 m. Diámetro: Ø 14 mm. Material: Acero inoxidable.

9134630

14,50

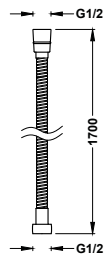

Flexo metálico reforzado

Long: 1,70 m. Tuerca cónica con junta tórica y arandela prisionera en racor. Garantía de diez años.

9134828

17,80

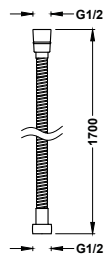

Flexo metálico reforzado y extensible

Long: 1,70 m. Tuerca cónica con junta tórica y arandela prisionera en racor. Garantía de diez años.

913483080

19,80

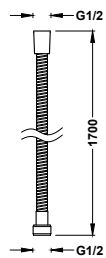

Flexo metálico

Long: 1,70 m.

9134830053

80,00

9134830054

160,00

9134830051

80,00

913483005LM

80,00

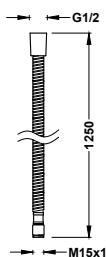

Flexo metálico reforzado

Long: 1,25 m. Diámetro: Ø 12 mm. Para ref.: 30444, 41443, 41444, 44444, 50443, 52444, 54444, 70443, 72443, 73443, 73444, 39444, 69444.

9134867

32,50

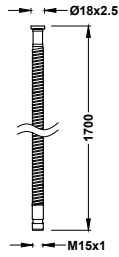

Flexo metálico

Long.: 1,70 m. Diámetro: Ø 12 mm. Para ref.: 30430, 30432, 30433, 14444, 43444, 87444, 130460, 62438, 30452, 81438.

9134712

28,00

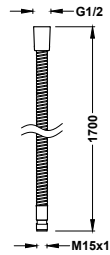

Flexo metálico reforzado

Long.: 1,70 m. Tuerca cónica con junta tórica y arandela prisionera en racor. Garantía de diez años. Para ref.: 06161, 07161, 14150, 17145, 39145, 41145, 43145, 43147, 44145, 43147, 44145, 61150, 61161, 61181, 62150, 62161, 63145, 63181, 69145, 72145, 73145, 74145, 85145, 87150, 87161, 87181, 89150, 70145, 81150, 81161, 89161, 200161, 200162, 202161, 202661, 203161, 205161, 261150, 262150.

9134881

32,00

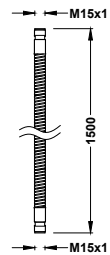

Flexo metálico

Long.: 1,50 m. Para ref.: 145 CLASICTRES, MONOCLASIC 1900, RETROTRES.

9134731

32,50

9134731051

80,00

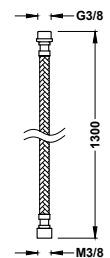

Flexo para ducha de peluquería

Long.: 1,30 m. Para ref.: 72450. Material: Nylon negro.

9134887

33,50

BARRAS DESLIZANTES

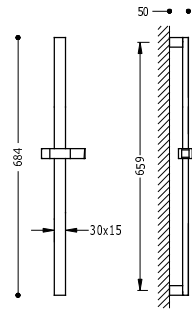

Barra deslizante para ducha

Barra de ducha de latón: long. 659 mm. Soporte deslizante y orientable para ducha de mano.

134516

66,00

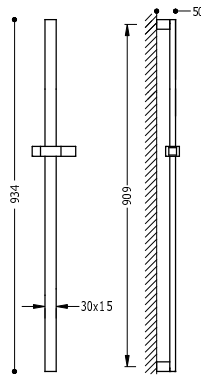

Barra deslizante para ducha

Barra de ducha de latón: long. 909 mm. Soporte deslizante y orientable para ducha de mano.

134517

98,00

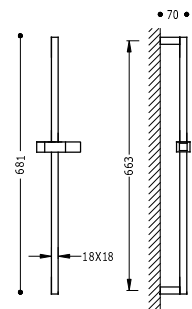

Barra deslizante para ducha

Barra de ducha de latón: long. 663 mm. Soporte deslizante y orientable para ducha de mano.

107922

66,00

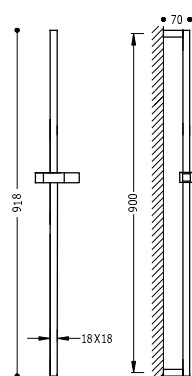

Barra deslizante para ducha

Barra de ducha de latón: long. 900 mm. Soporte deslizante y orientable para ducha de mano.

134520

98,00

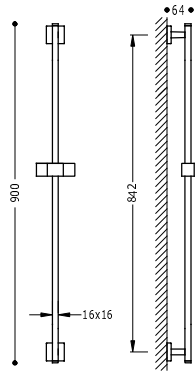

Barra deslizante para ducha

Barra de ducha de latón: long. 842 mm. Soporte deslizante y orientable para ducha de mano.

107935

135,00

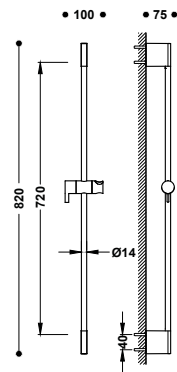

Barra deslizante para ducha

Barra de ducha: long. 800 mm y \varnothing 14 mm. Soporte deslizante y orientable para ducha de mano.

03463701

84,00

03463701NM

130,00

03463701BM

130,00

03463701AC

130,00

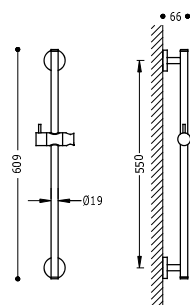

Barra deslizante para ducha

Barra de ducha: long. 550 mm y \varnothing 19 mm. Soporte deslizante y orientable para ducha de mano.

134618

50,00

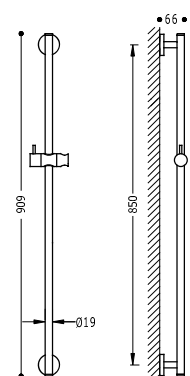

Barra deslizante para ducha

Barra de ducha: long. 850 mm y \varnothing 19 mm. Soporte deslizante y orientable para ducha de mano.

134619

68,00



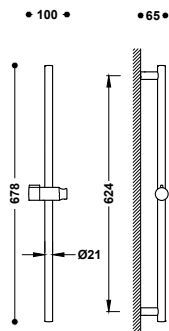

Barra deslizante para ducha

Barra de ducha: long. 624 mm y Ø 20,6 mm. Soporte deslizante y orientable para ducha de mano.

03463702

62,50

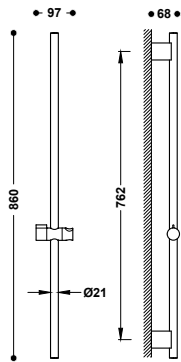

Barra deslizante para ducha

Barra de ducha: long. 762 mm y Ø 20,6 mm. Soporte deslizante y orientable para ducha de mano.

03463708

92,50

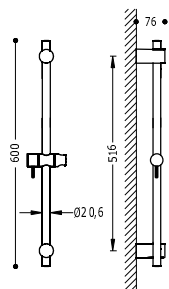

Barra deslizante para ducha

Barra de ducha con fijaciones regulables en altura: long. 516 mm y Ø 20,6 mm. Soporte deslizante y orientable para ducha de mano.

161835

37,20

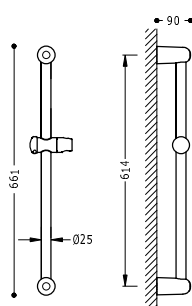

Barra deslizante para ducha

Barra de ducha: long. 614 mm y Ø 25 mm. Soporte deslizante y orientable para ducha de mano.

143835

23,80

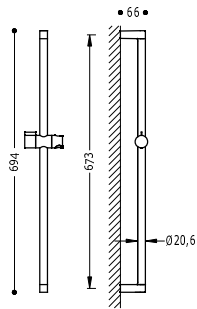

Barra deslizante para ducha

Barra de ducha: long. 673 mm y Ø 20,6 mm. Soporte deslizante y orientable para ducha de mano.

03463706

32,00

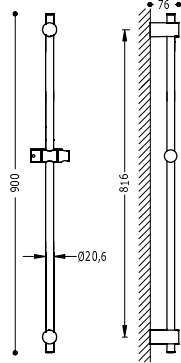

Barra deslizante para ducha

Barra de ducha con fijaciones regulables en altura: long. 816 mm y Ø 20,6 mm. Soporte deslizante y orientable para ducha de mano.

161838

57,00

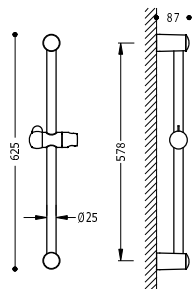

Barra deslizante para ducha

Barra de ducha: long. 578 mm y Ø 25 mm. Soporte deslizante y orientable para ducha de mano.

134835

62,00

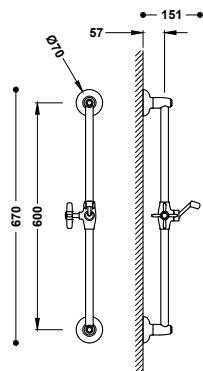

Barra deslizante para ducha

Barra de ducha: 600 mm y Ø 20,6 mm. Soporte deslizante y orientable para ducha de mano.

24273201

210,00

24273201AC

326,00

24273201LV

294,00

24273201LM

294,00



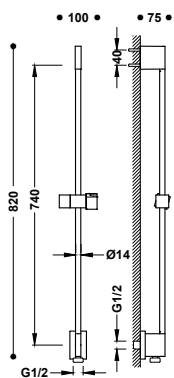

Barra deslizante para ducha con toma de agua a pared

Barra de ducha: 740 mm y Ø 14 mm. Soporte deslizante y orientable para ducha de mano.

- 03493299 **145,00**
- 03493299NM **225,00**
- 03493299BM **225,00**
- 03493299AC **225,00**

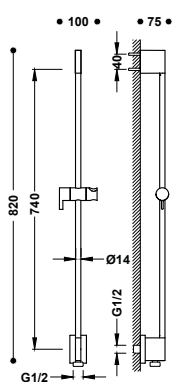

Barra deslizante para ducha con toma de agua a pared

Barra de ducha: 740 mm y Ø 14 mm. Soporte deslizante y orientable para ducha de mano.

- 03493199 **138,00**
- 03493199NM **214,00**
- 03493199BM **214,00**
- 03493199AC **214,00**

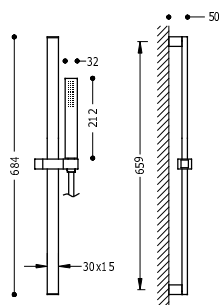

Conjunto de barra de ducha

Barra de ducha de latón: long. 659 mm. Soporte deslizante y orientable para ducha de mano. Ducha de mano anticalcárea de latón. Flexo satinado.

- 03452602 **115,00**

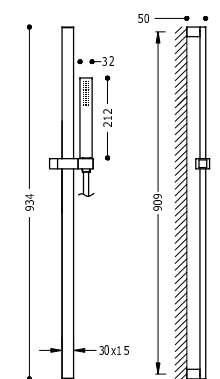
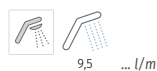

Conjunto de barra de ducha

Barra de ducha de latón: long. 909 mm. Soporte deslizante y orientable para ducha de mano. Ducha de mano anticalcárea de latón. Flexo satinado.

- 03452702 **150,00**

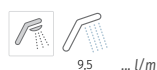

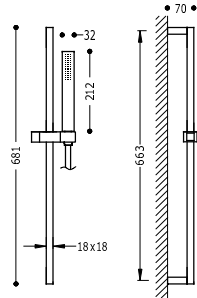

Conjunto de barra de ducha

Barra de ducha de latón: long. 663 mm. Soporte deslizante y orientable para ducha de mano. Ducha de mano anticalcárea de latón. Flexo satinado.

03433603

115,00

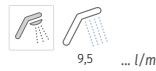

9,5 ... l/m

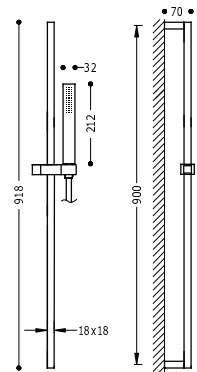

Conjunto de barra de ducha

Barra de ducha de latón: long. 900 mm. Soporte deslizante y orientable para ducha de mano. Ducha de mano anticalcárea de latón. Flexo satinado.

03433604

150,00

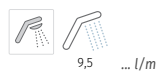

9,5 ... l/m

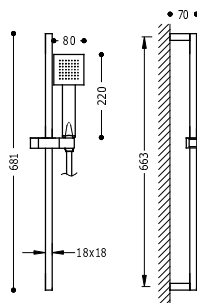

Conjunto de barra de ducha

Barra de ducha de latón: long. 663 mm. Soporte deslizante y orientable para ducha de mano. Ducha de mano anticalcárea. Flexo satinado.

134512

102,00

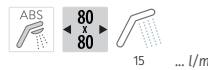

15 ... l/m

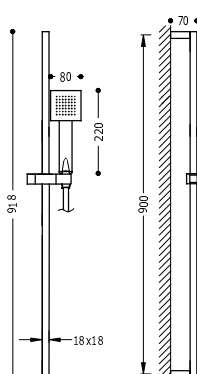

Conjunto de barra de ducha

Barra de ducha de latón: long. 900 mm. Soporte deslizante y orientable para ducha de mano. Ducha de mano anticalcárea. Flexo satinado.

134522

137,00

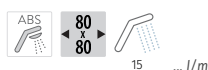

15 ... l/m



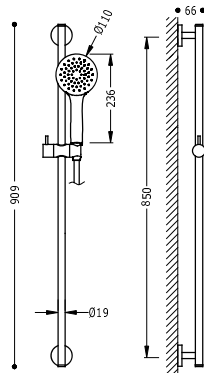

Conjunto de barra de ducha

Barra de ducha: long. 850 mm y \varnothing 19 mm. Soporte deslizante y orientable para ducha de mano. Ducha de mano anticalcárea. Flexo satinado.

06192801

112,00

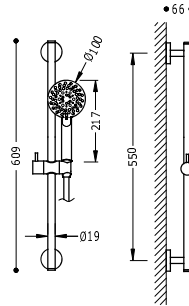

Conjunto de barra de ducha

Barra de ducha: long. 550 mm y \varnothing 19 mm. Soporte deslizante y orientable para ducha de mano. Ducha de mano anticalcárea: \varnothing 100 mm. (5 tipos de chorro). Flexo satinado.

134628

118,00

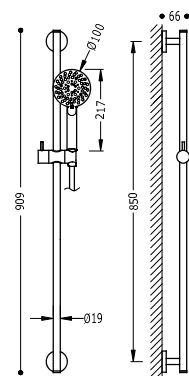
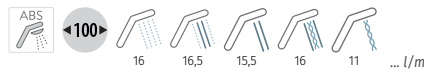

Conjunto de barra de ducha

Barra de ducha: long. 850 mm y \varnothing 19 mm. Soporte deslizante y orientable para ducha de mano. Ducha de mano anticalcárea: \varnothing 100 mm. (5 tipos de chorro). Flexo satinado.

134629

133,00

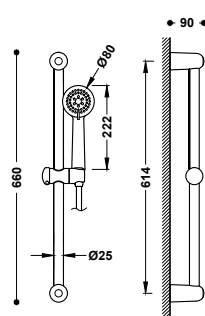

Conjunto de barra de ducha

Barra de ducha: long. 614 mm y \varnothing 25 mm. Soporte deslizante y orientable para ducha de mano. Ducha de mano anticalcárea: \varnothing 80 mm. (2 tipos de chorro). Flexo satinado.

143836

60,80

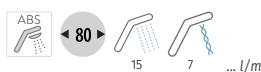

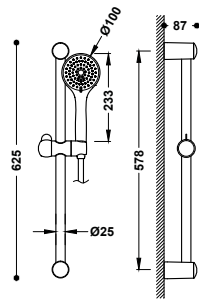

Conjunto de barra de ducha

Barra de ducha: long. 578 mm y \varnothing 25 mm. Soporte deslizante y orientable para ducha de mano \varnothing 100 mm. (3 tipos de chorro). Ducha de mano anticálcarea. Flexo satinado.

134923

98,30

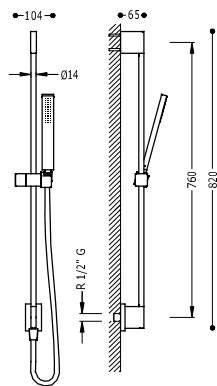

Conjunto de barra de ducha con toma de agua a pared

Barra de ducha: 760 mm y \varnothing 14 mm. Soporte deslizante y orientable para ducha de mano. Ducha de mano anticálcarea de latón. Flexo satinado.

03493201

198,00

03493201NM

307,00

03493201BM

307,00

03493201AC

307,00

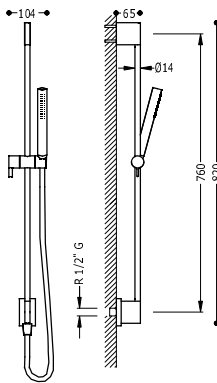

Conjunto de barra de ducha con toma de agua a pared

Barra de ducha: 760 mm y \varnothing 14 mm. Soporte deslizante y orientable para ducha de mano. Ducha de mano anticálcarea de latón. Flexo satinado.

03493101

191,00

03493101NM

296,00

03493101BM

296,00

03493101AC

296,00

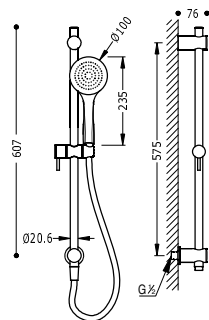
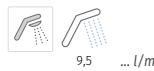

Conjunto de barra de ducha con toma de agua a pared

Soporte con toma de agua a pared. Barra de ducha: long. 575 mm y \varnothing 20,6 mm. Soporte deslizante y orientable para ducha de mano. Ducha de mano anticálcarea. Flexo satinado.

06193103

127,00



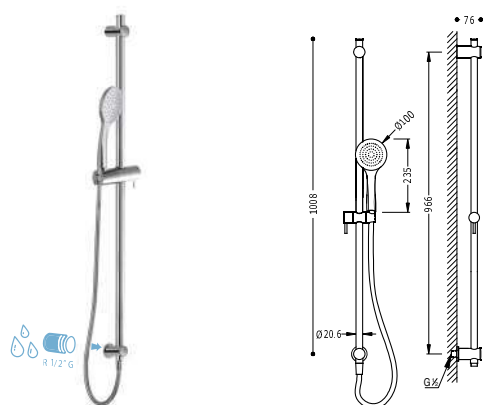

Conjunto de barra de ducha con toma de agua a pared

06193105

147,00

Soporte con toma de agua a pared. Barra de ducha: long. 966 mm y Ø 20,6 mm. Soporte deslizante y orientable para ducha de mano. Ducha de mano anticalcárea. Flexo satinado.

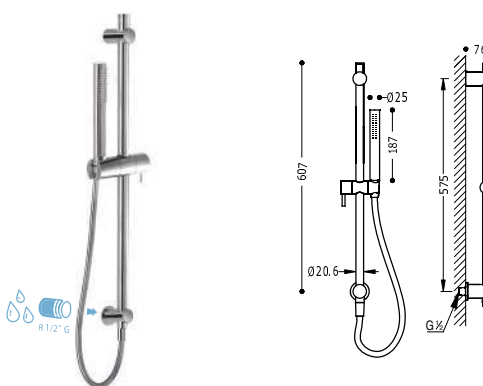

Conjunto de barra de ducha con toma de agua a pared

06193102

130,00

Soporte con toma de agua a pared. Barra de ducha: long. 575 mm y Ø 20,6 mm. Soporte deslizante y orientable para ducha de mano. Ducha de mano anticalcárea de latón. Flexo satinado.

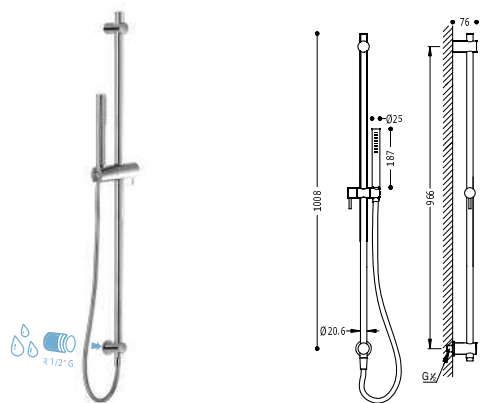
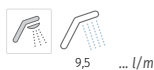

Conjunto de barra de ducha con toma de agua a pared

06193104

150,00

Soporte con toma de agua a pared. Barra de ducha: long. 966 mm y Ø 20,6 mm. Soporte deslizante y orientable para ducha de mano. Ducha de mano anticalcárea de latón. Flexo satinado.



KITS DE DUCHA

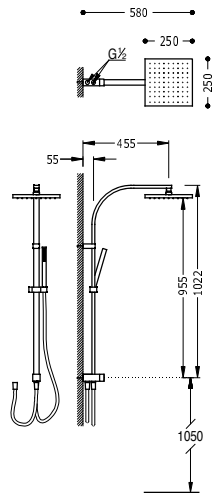
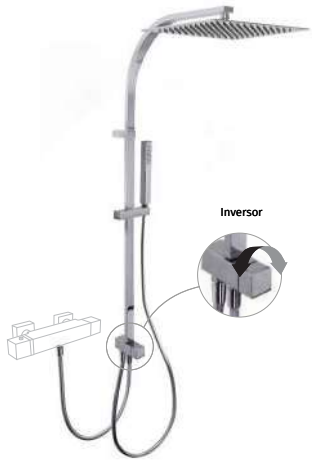

Conjunto de ducha adaptable a cualquier grifo

107926

357,00

- Con inversor integrado en la barra de ducha.
- Rociador de ducha orientable de acero inoxidable: 250x250 mm.
- Soporte deslizante y orientable para ducha de mano.
- Ducha de mano anticalcárea de latón.
- Flexo satinado.

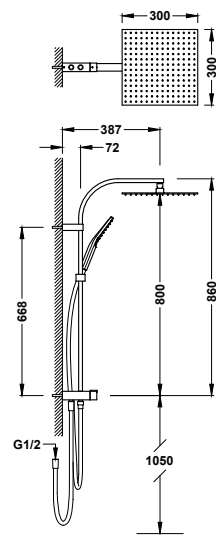
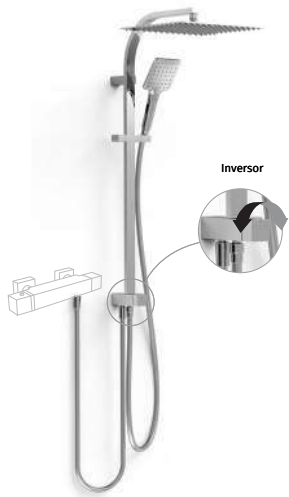
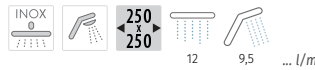

Conjunto de ducha adaptable a cualquier grifo

19063504

332,00

- Con inversor integrado en la barra de ducha.
- Rociador de ducha orientable de acero inoxidable: 300x300 mm.
- Soporte deslizante y orientable para ducha de mano.
- Ducha de mano anticalcárea: 96x110 mm. (3 tipos de chorro).
- Flexo satinado.

- 19063504NM 514,00
- 19063504BM 514,00
- 19063504AC 514,00
- 19063504OM 663,00

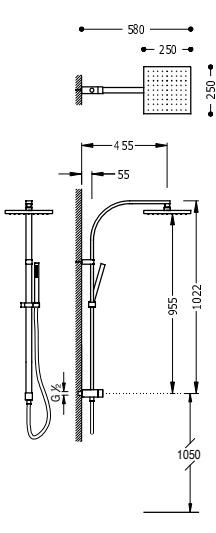
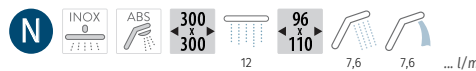

Conjunto de barra de ducha sin grifo con toma de agua y rociador

107131

355,00

- Con inversor integrado en la barra de ducha.
- Rociador de ducha orientable de acero inoxidable: 250x250 mm.
- Soporte deslizante y orientable para ducha de mano.
- Ducha de mano anticalcárea de latón.
- Flexo satinado.

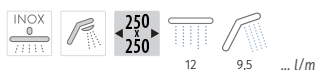

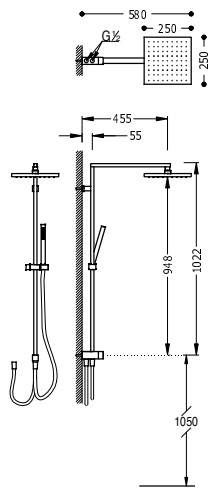

Conjunto de ducha adaptable a cualquier grifo

107476

360,00

- Con inversor integrado en la barra de ducha.
- Rociador de ducha orientable de acero inoxidable: 250x250 mm.
- Soporte deslizante y orientable para ducha de mano.
- Ducha de mano anticalcárea de latón.
- Flexo satinado.

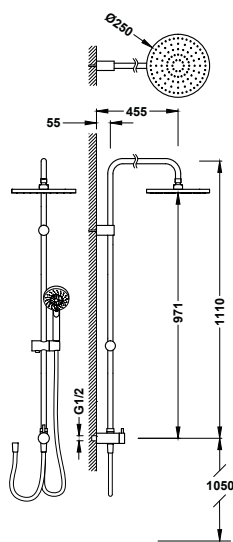
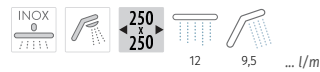

Conjunto de ducha adaptable a cualquier grifo

161475

245,00

- Con inversor integrado en la barra de ducha.
- Rociador de ducha orientable de acero inoxidable: Ø 250 mm.
- Soporte deslizante y orientable para ducha de mano.
- Ducha de mano anticalcárea: Ø 100 mm. (5 tipos de chorro).
- Flexo satinado.

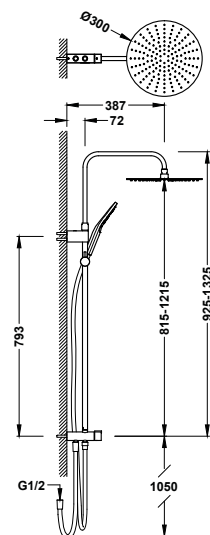

Conjunto de ducha adaptable a cualquier grifo

19063502

345,00

- Con inversor integrado en la barra de ducha.
- Rociador de ducha orientable de acero inoxidable: Ø 300 mm.
- Soporte deslizante y orientable para ducha de mano.
- Ducha de mano anticalcárea: Ø 110 mm. (3 tipos de chorro).
- Flexo satinado.

- 19063502NM **535,00**
- 19063502BM **535,00**
- 19063502KMB **535,00**
- 19063502OM **691,00**
- 19063502OPM **691,00**



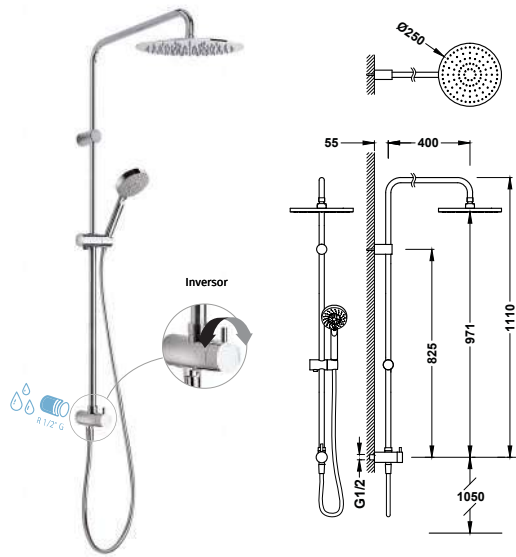

Conjunto de barra de ducha sin grifo con toma de agua y rociador

06163505

243,00

- Con inversor integrado en la barra de ducha.
- Rociador de ducha orientable de acero inoxidable: Ø 250 mm.
- Soporte deslizante y orientable para ducha de mano.
- Ducha de mano anticalcárea: Ø 100 mm. (5 tipos de chorro).
- Flexo satinado.

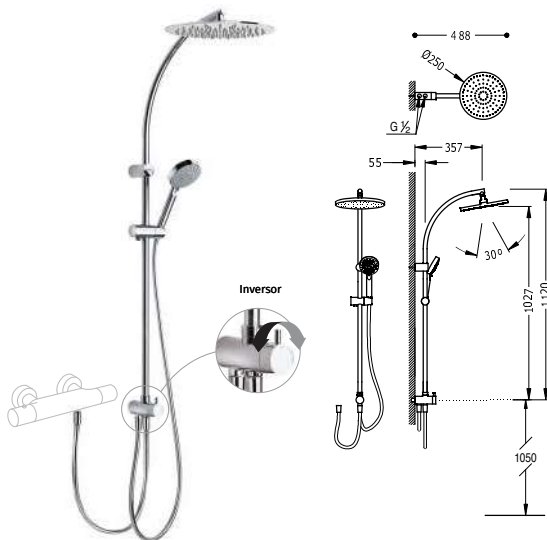

Conjunto de ducha adaptable a cualquier grifo

161476

299,00

- Con inversor integrado en la barra de ducha.
- Rociador de ducha orientable de acero inoxidable: Ø 250 mm.
- Soporte deslizante y orientable para ducha de mano.
- Ducha de mano anticalcárea: Ø 100 mm. (5 tipos de chorro).
- Flexo satinado.

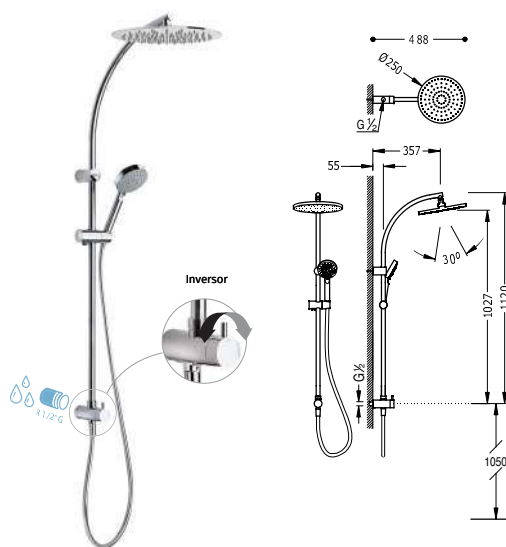

Conjunto de barra de ducha sin grifo con toma de agua y rociador

06163504

297,00

- Con inversor integrado en la barra de ducha.
- Rociador de ducha orientable de acero inoxidable: Ø 250 mm.
- Soporte deslizante y orientable para ducha de mano.
- Ducha de mano anticalcárea: Ø 100 mm. (5 tipos de chorro).
- Flexo satinado.

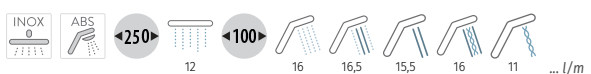

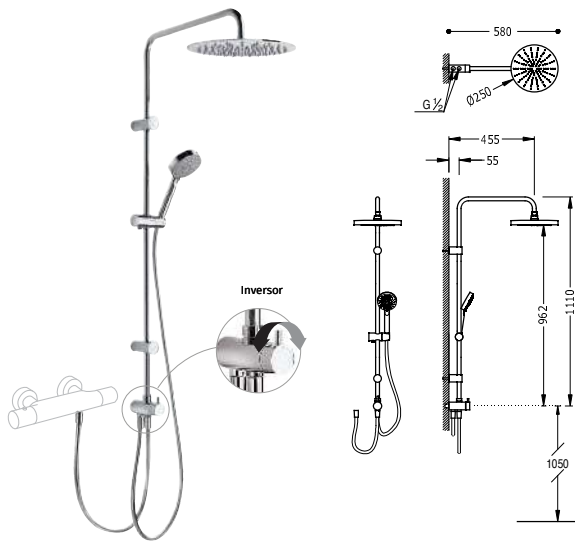

Conjunto de ducha adaptable a cualquier grifo

161214

300,00

- Con inversor integrado en la barra de ducha.
- Rociador de ducha orientable de acero inoxidable: Ø 250 mm.
- Soporte deslizante y orientable para ducha de mano.
- Ducha de mano anticalcárea: Ø 100 mm. (5 tipos de chorro).
- Flexo satinado.

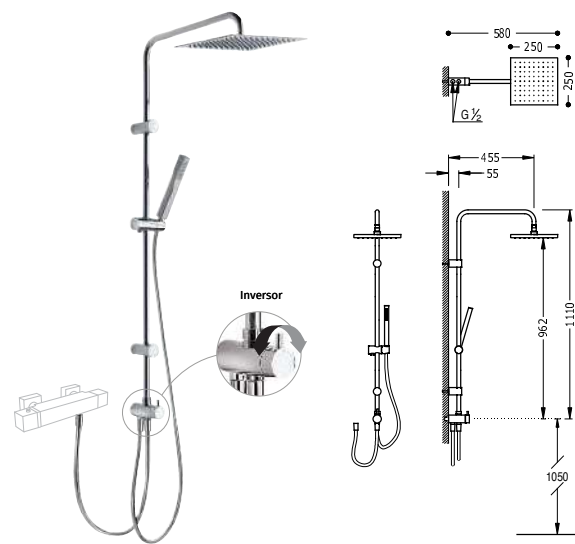

Conjunto de ducha adaptable a cualquier grifo

06163506

320,00

- Con inversor integrado en la barra de ducha.
- Rociador de ducha orientable de acero inoxidable: 250x250 mm.
- Soporte deslizante y orientable para ducha de mano.
- Ducha de mano anticalcárea de latón.
- Flexo satinado.

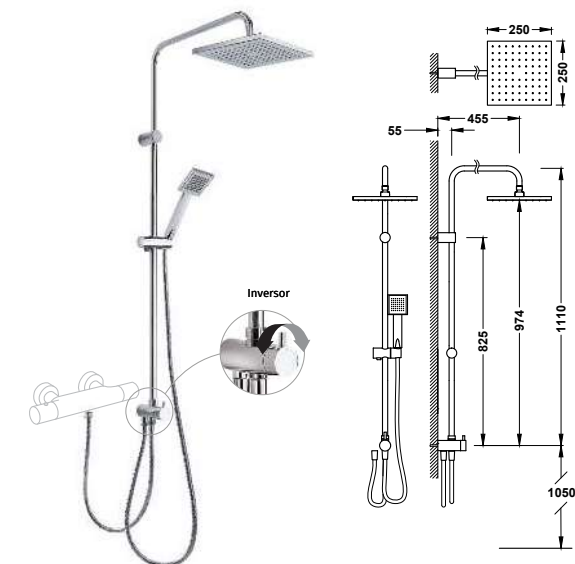
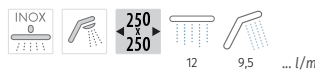

Conjunto de ducha adaptable a cualquier grifo

20047501

240,00

- Con inversor integrado en la barra de ducha.
- Rociador de ducha orientable: 250x250 mm.
- Soporte deslizante y orientable para ducha de mano.
- Ducha de mano anticalcárea: 80x80 mm.
- Flexo metálico reforzado.



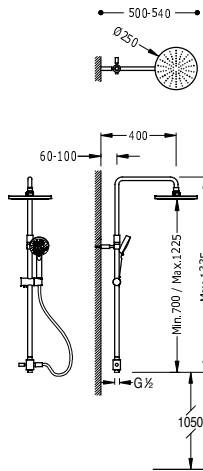

Conjunto de barra de ducha sin grifo con toma de agua y rociador

161213

326,00

- Con inversor integrado en la barra de ducha.
- Barra de ducha telescópica.
- Rociador de ducha orientable de acero inoxidable: Ø 250 mm.
- Soporte deslizante y orientable para ducha de mano.
- Ducha de mano anticalcárea: Ø 100 mm. (5 tipos de chorro).
- Flexo satinado.

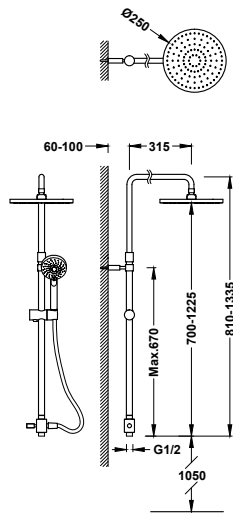
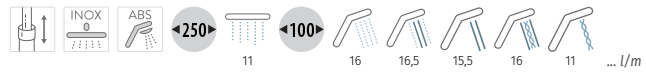

Conjunto de barra de ducha sin grifo con toma de agua y rociador

06163509

295,00



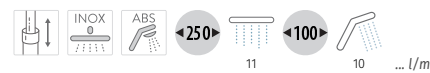



- Con inversor integrado en la barra de ducha.
- Barra de ducha telescópica.
- Rociador de ducha orientable de acero inoxidable: Ø 250 mm.
- Soporte deslizante y orientable para ducha de mano.
- Ducha de mano anticalcárea: Ø 100 mm.
- Flexo satinado.



SOPORTES ORIENTABLES











Soporte orientable para ducha de mano
Material: Latón.



	107839	29,50
	107839NM	45,75
	107839BM	45,75
	50783903	45,75
	107839OR	59,00
	107839OM	59,00





Soporte orientable para ducha de mano
Material: Latón.



	161839	27,50
	06183901NM	42,65
	06183901BM	42,65
	06183901AC	42,65
	06183901KM	42,65
	06183901KMB	42,65
	06183901OR	55,00
	06183901OM	55,00
	06183901OPM	55,00 

Soporte orientable para ducha de mano
Material: Latón.



	29963910	38,00
	29963910AC	58,90
	29963910OR	76,00
	29963910LV	53,20
	29963910LM	53,20

Soporte orientable para ducha de mano



	29963901	9,50
---	----------	-------------

Soporte orientable para ducha de mano



	29963928	6,30
---	----------	-------------

Soporte articulado con 3 posiciones para ducha de mano

134215023

5,00



Soporte fijo para ducha de mano

9134841

7,20



Soporte fijo con 2 posiciones para ducha de mano

9134848

7,20



SOPORTES CON TOMA A PARED

Soporte fijo con toma de agua para ducha de mano y flexo
Válvula antirretorno. Material: Latón.

20718201

70,00

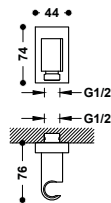

- 20718201NM 109,00
- 20718201BM 109,00
- 20718201AC 109,00
- 20718201OR 140,00
- 20718201OM 140,00

Soporte fijo con toma de agua para ducha de mano y flexo
Válvula antirretorno.

20018201

52,00

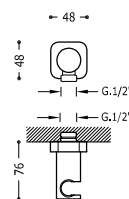

- 20018201NM 80,60
- 20018201BM 80,60
- 20018201AC 80,60
- 20018201OR 104,00
- 20018201OM 104,00

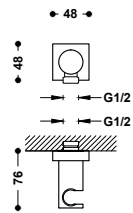

Soporte fijo con toma de agua para ducha de mano y flexo
Válvula antirretorno.

	21118201	52,00
	21118201NM	80,60
	21118201BM	80,60
	21118201AC	80,60
	21118201KM	80,60
	21118201KMB	80,60
	21118201OR	104,00
	21118201OM	104,00
	21118201OP	104,00
	21118201OPM	104,00

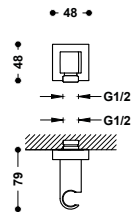

Soporte fijo con toma de agua para ducha de mano y flexo
Válvula antirretorno.

	20218201	63,00
	20218201NM	97,65
	20218201BM	97,65
	20218201AC	97,65
	20218201OR	126,00
	20218201OM	126,00

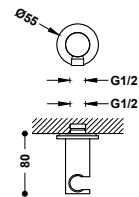

Soporte fijo con toma de agua para ducha de mano y flexo
Válvula antirretorno.

	21518201	48,00
--	----------	--------------

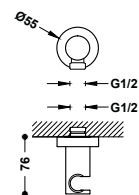

Soporte fijo con toma de agua para ducha de mano y flexo
Válvula antirretorno.

	26118201	52,00
	26118201NM	80,60
	26118201BM	80,60
	26118201AC	80,60
	26118201KM	80,60
	26118201KMB	80,60
	26118201OR	104,00
	26118201OM	104,00
	26118201OP	104,00
	26118201OPM	104,00

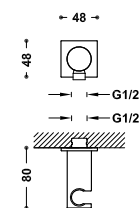

Soporte fijo con toma de agua para ducha de mano y flexo
Válvula antirretorno.

	21618201	48,00
--	----------	--------------

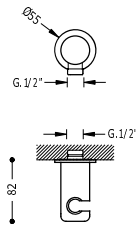

Soporte fijo con toma de agua para ducha de mano y flexo
Válvula antirretorno.

02418201

52,00

CODO ADAPTADOR A PARED

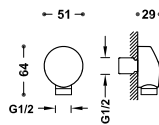

Codo con toma a pared para flexo
Con toma de agua a pared G1/2.

134757

22,30

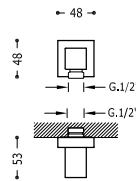

Codo con toma a pared para flexo
Con toma de agua a pared G1/2.

00618301

60,00

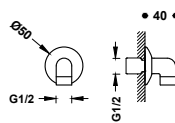

Codo con toma a pared para flexo
Con toma de agua a pared G1/2.

134873

20,00

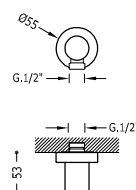

Codo con toma a pared para flexo
Con toma de agua a pared G1/2.

20518301

33,50

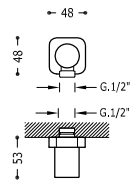

Codo con toma a pared para flexo
Con toma de agua a pared G1/2.

20018301

33,50

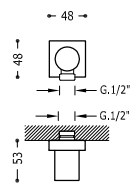

Codo con toma a pared para flexo
Con toma de agua a pared G1/2.

06118301

33,50

JETS

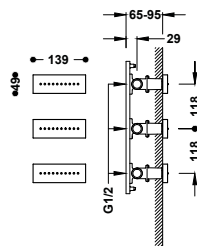

3 jets empotrados de hidromasaje
Con perfil de instalación incluido. Material: Latón. Medida: 139x49 mm.

29951504

660,00

- 29951504NM **1.023,00**
- 29951504BM **1.023,00**
- 29951504AC **1.023,00**
- 29951504OR **1.320,00**
- 29951504OM **1.320,00**

7,9 ... l/m

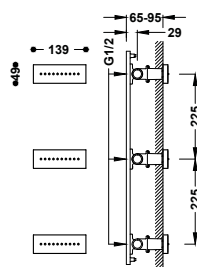
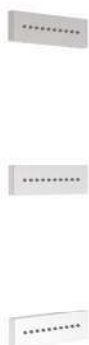

3 jets empotrados de hidromasaje
Con perfil de instalación incluido. Material: Latón. Medida: 139x49 mm.

29951505

675,00

- 29951505NM **1.046,00**
- 29951505BM **1.046,00**
- 29951505AC **1.046,00**
- 29951505OR **1.350,00**
- 29951505OM **1.350,00**

7,9 ... l/m

3 jets empotrados giratorios de hidromasaje
 Con perfil de instalación incluido. Medida: 80x80 mm.

29951506 **400,00**

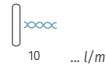
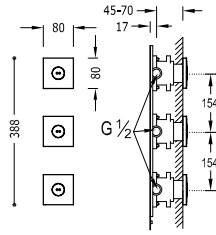

3 jets empotrados giratorios de hidromasaje
 Con perfil de instalación incluido. Medida: 80x80 mm.

29951507 **415,00**

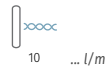
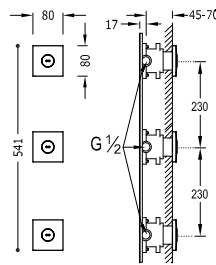

3 jets empotrados de hidromasaje
 Con perfil de instalación incluido. Medida: 80x80 mm.

13451501 **450,00**

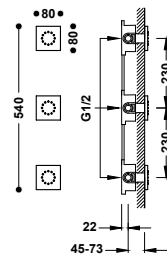

- 13451501NM **698,00**
- 13451501BM **698,00**
- 13451501AC **698,00**
- 13451501KM **698,00**
- 13451501KMB **698,00**
- 13451501OR **900,00**
- 13451501OM **900,00**
- 13451501OP **900,00**
- 13451501PM **900,00**

Jet empotrado de hidromasaje
 Con rótula orientable. 1 tipo de chorro. Incluye un sistema anticañal, válvula antirretorno y limitador de caudal: 5 l/min.

9161515 **123,00**

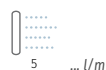
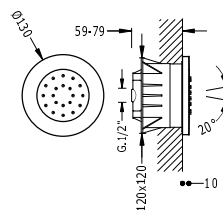

Jet empotrado de hidromasaje

9107515

128,00

Con rótula orientable. 1 tipo de chorro. Incluye un sistema antical, válvula antirretorno y limitador de caudal: 5 l/min.

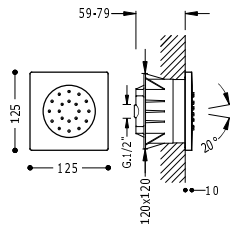
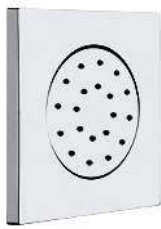

Jet de hidromasaje

9134515

57,00

Con rótula orientable. 1 tipo de chorro. Incluye un sistema antical, válvula antirretorno y limitador de caudal: 5 l/min. Material: Latón.

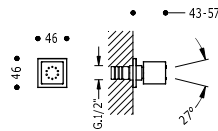

Jet de hidromasaje

29951501

60,00

Con rótula orientable. 1 tipo de chorro. Incluye un sistema antical, válvula antirretorno y limitador de caudal: 5 l/min. Material: Latón.

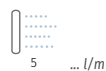
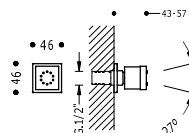

Jet de hidromasaje

29951503

52,00

Con rótula orientable. 1 tipo de chorro. Incluye un sistema antical, válvula antirretorno y limitador de caudal: 5 l/min. Material: Latón.

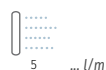
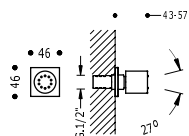

Jet de hidromasaje

Con rótula orientable. 1 tipo de chorro. Incluye un sistema anticaul, válvula antiretorno y limitador de caudal: 5 l/min. Material: Latón.

29951502

53,00

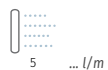
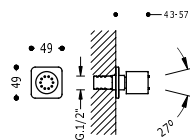

Jet de hidromasaje

Con rótula orientable. 1 tipo de chorro. Incluye un sistema anticaul, válvula antiretorno y limitador de caudal: 5 l/min. Material: Latón.

9134415

43,00

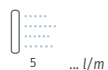
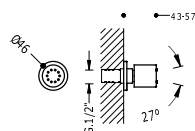

Jet de hidromasaje

Con rótula orientable. 2 tipos de chorro. Caudal: 6 l/min y 4.5 l/min.

9134915

34,00

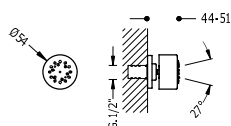

Jet de hidromasaje

Con rótula orientable. 1 tipo de chorro. Caudal: 4 l/min.

9134615

28,00

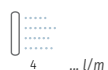
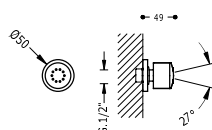



ACCESORIOS DE BAÑO



Cuadrado	414
Redondo	415
Clásico	416

CUADRADO

Toallero
400 mm.

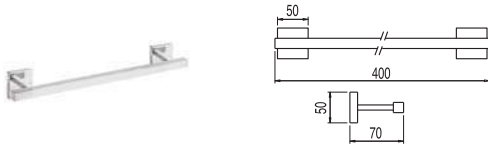

	10723601	65,00
	10723601NM	101,00
	10723601BM	101,00
	10723601AC	101,00
	10723601KM	101,00 
	10723601KMB	101,00 
	10723601OR	130,00
	10723601OM	130,00
	10723601OP	130,00 
	10723601OPM	130,00 



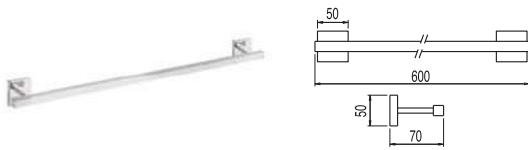





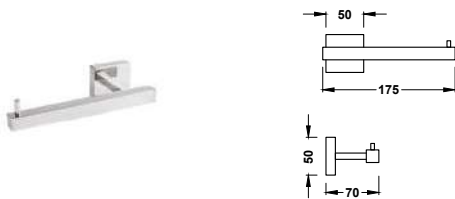





Toallero
600 mm.



	10723603	65,00
	10723603NM	101,00
	10723603BM	101,00
	10723603AC	101,00
	10723603KM	101,00 
	10723603KMB	101,00 
	10723603OR	130,00
	10723603OM	130,00
	10723603OP	130,00 
	10723603OPM	130,00 









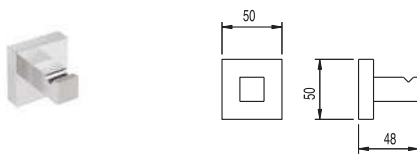





Portarrollos sin tapa



	10723606	30,00
	10723606NM	46,50
	10723606BM	46,50
	10723606AC	46,50
	10723606KM	46,50 
	10723606KMB	46,50 
	10723606OR	60,00
	10723606OM	60,00
	10723606OP	60,00 
	10723606OPM	60,00 

Percha



	10723620	25,00
	10723620NM	38,75
	10723620BM	38,75
	10723620AC	38,75
	10723620KM	38,75 
	10723620KMB	38,75 
	10723620OR	50,00
	10723620OM	50,00
	10723620OP	50,00 
	10723620OPM	50,00 

REDONDO

Toallero
480 mm.



	16123601	60,00
	16123601NM	93,00
	16123601BM	93,00
	16123601AC	93,00
	16123601KM	93,00 N
	16123601KMB	93,00 N
	16123601OR	120,00
	16123601OM	120,00
	16123601OP	120,00 N
	16123601OPM	120,00 N

Toallero
580 mm.



	16123602	60,00
	16123602NM	93,00
	16123602BM	93,00
	16123602AC	93,00
	16123602KM	93,00 N
	16123602KMB	93,00 N
	16123602OR	120,00
	16123602OM	120,00
	16123602OP	120,00 N
	16123602OPM	120,00 N

Portarrollos sin tapa



	16123606	25,00
	16123606NM	38,75
	16123606BM	38,75
	16123606AC	38,75
	16123606KM	38,75 N
	16123606KMB	38,75 N
	16123606OR	50,00
	16123606OM	50,00
	16123606OP	50,00 N
	16123606OPM	50,00 N

Asidero para bañera
306 mm.

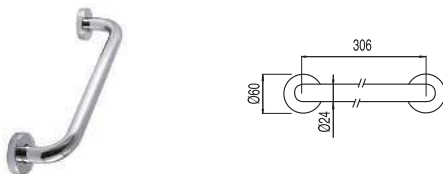

	134184	35,00
	134184NM	54,25 N
	134184BM	54,25 N
	134184AC	54,25 N
	134184KM	54,25 N
	134184KMB	54,25 N
	134184OR	70,00 N
	134184OM	70,00 N
	134184OP	70,00 N
	134184OPM	70,00 N

Percha

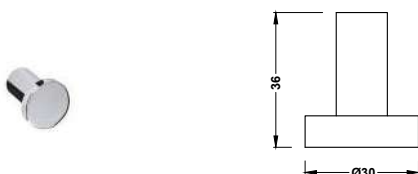



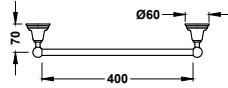

	16123620	15,00
	16123620NM	23,25
	16123620BM	23,25
	16123620AC	23,25
	16123620KM	23,25 N
	16123620KMB	23,25 N
	16123620OR	30,00
	16123620OM	30,00
	16123620OP	30,00 N
	16123620OPM	30,00 N

CLÁSICO





Toallero
400 mm.

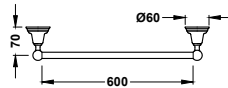

	12423601	78,00
	12423601AC	121,00
	12423601OR	156,00
	12423601LV	109,00
	12423601LM	109,00





Toallero
600 mm.

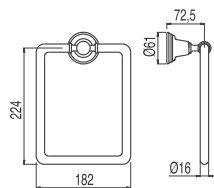

	12423603	78,00
	12423603AC	121,00
	12423603OR	156,00
	12423603LV	109,00
	12423603LM	109,00





Toallero de anilla cuadrada

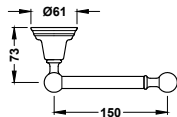

	12463609	76,00
	02463609AC	118,00
	02463609OR	152,00
	5246360951	106,00
	02463609LM	106,00





Portarrollos sin tapa

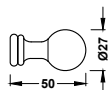

	12423606	43,00
	12423606AC	66,65
	12423606OR	86,00
	12423606LV	60,20
	12423606LM	60,20

Percha



	12423607	16,00
	12423607AC	24,80
	12423607OR	32,00
	12423607LV	22,40
	12423607LM	22,40



TECNOLOGÍA ELECTRÓNICA





Shower Technology	420
Lavabos	429
Dispensadores de jabón	435
Sensores WC	436
Cocina electrónica	437

COMPLETA TU DUCHA ELECTRÓNICA



+

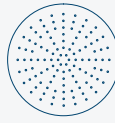

2 vías (492 862 99 - 492 882 99)

3 vías (492 863 98 - 492 883 98)

3 vías (492 863 99 - 492 883 99)

4 vías (492 864 99 - 492 884 99)

Se recomienda la instalación de complementos de ducha de Tres para garantizar su buen funcionamiento.

PANTALLA DE CONTROL

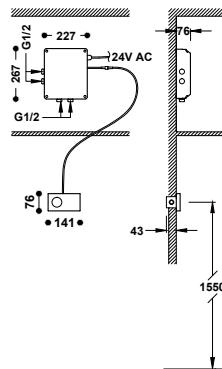

Control termostático electrónico empotrado de 2 vías Shower Technology Blue Edition

49286299

990,00

49288299

990,00

- Control electrónico incluido con juntas antihumedad Schlüter.
- Centralita termostática electrónica incluida (2 vías).
- Temperatura mínima disponible inferior a los 25°C.
- Sistema puesta a punto: Preparación de la temperatura deseada.
- Con programas antilegionela.

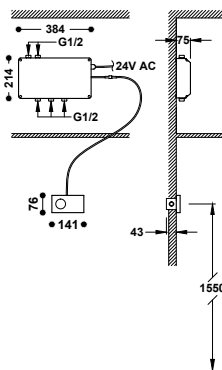

Control termostático electrónico empotrado de 3 vías Shower Technology Blue Edition

49286398

1.060,00

49288398

1.060,00

- Control electrónico incluido con juntas antihumedad Schlüter.
- Centralita termostática electrónica incluida (3 vías).
- Temperatura mínima disponible inferior a los 25°C.
- Sistema puesta a punto: Preparación de la temperatura deseada.
- Con programas antilegionela.



**Control termostático electrónico empotrado de 3 vías
Shower Technology Blue Edition**

49286399 **1.060,00**
49288399 **1.060,00**

- Control electrónico incluido con juntas antihumedad Schlüter.
- Centralita termostática electrónica incluida (3 vías).
- Temperatura mínima disponible inferior a los 25°C.
- Sistema puesta a punto: Preparación de la temperatura deseada.
- Con programas antilegionela.

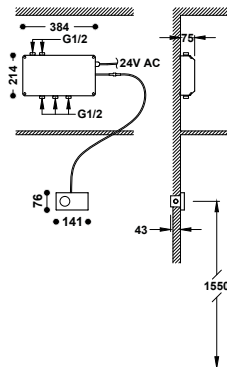

**Control termostático electrónico empotrado de 4 vías
Shower Technology Blue Edition**

49286499 **1.130,00**
49288499 **1.130,00**

- Control electrónico incluido con juntas antihumedad Schlüter.
- Centralita termostática electrónica incluida (4 vías).
- Temperatura mínima disponible inferior a los 25°C.
- Sistema puesta a punto: Preparación de la temperatura deseada.
- Con programas antilegionela.

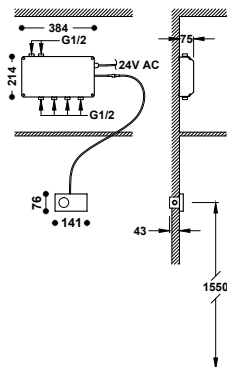

Soporte fijo con toma de agua para ducha de mano y flexo
Con toma de agua a pared. Válvula antirretorno. Material: Latón.

20718201 **70,00**
20718201NM **109,00**
20718201BM **109,00**
20718201AC **109,00**
20718201OR **140,00**
20718201OM **140,00**
20718201OPM **140,00** ^N

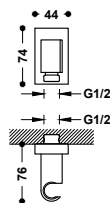

KITS DE 2 VÍAS

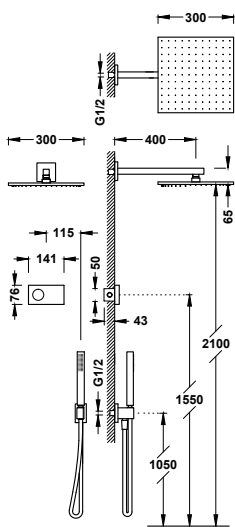

Kit de grifo termostático electrónico empotrado de 2 vías Shower Technology Blue Edition para ducha

- Control electrónico incluido con juntas antihumedad Schlüter.
- Centralita termostática electrónica incluida (2 vías).
- Brazo a pared de ducha orientable y de acero inoxidable: 300x300 mm.
- Soporte para ducha de mano con toma de agua a pared.
- Ducha de mano anticálcarea de latón.
- Flexo satinado.

- 09286563 **1.183,00**
- 09286563OM **1.585,00** N
- 09286563OPM **1.858,00** N



- 09288563NM **1.282,00**

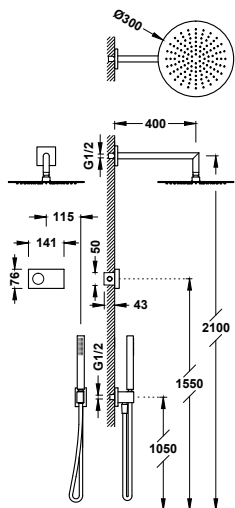

Kit de grifo termostático electrónico empotrado de 2 vías Shower Technology Blue Edition para ducha

- Control electrónico incluido con juntas antihumedad Schlüter.
- Centralita termostática electrónica incluida (2 vías).
- Brazo a pared con rociador de ducha orientable y de acero inoxidable: Ø 300 mm.
- Soporte para ducha de mano con toma de agua a pared.
- Ducha de mano anticálcarea de latón.
- Flexo satinado.

- 09286558 **1.138,00**
- 09286558OM **1.529,00** N
- 09286558OPM **1.529,00** N



- 09288558NM **1.239,00**

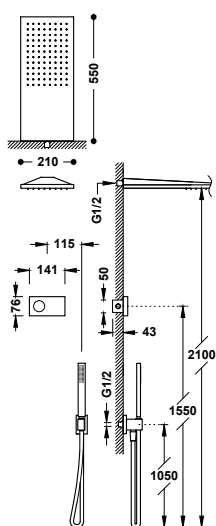

Kit de grifo termostático electrónico empotrado de 2 vías Shower Technology Blue Edition para ducha

- Control electrónico incluido con juntas antihumedad Schlüter.
- Centralita termostática electrónica incluida de 2 vías.
- Rociador de ducha a pared de acero inoxidable: 210x550 mm.
- Soporte para ducha de mano con toma de agua a pared.
- Ducha de mano anticálcarea de latón.
- Flexo satinado.

- 09286551 **1.318,00**
- 09286551OM **2.041,00** N
- 09286551OPM **2.041,00** N



- 09288551NM **1.636,00**



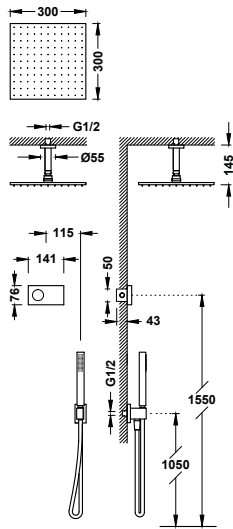

Kit de grifo termostático electrónico empotrado de 2 vías Shower Technology Blue Edition para ducha

- Control electrónico incluido con juntas antihumedad Schlüter.
- Centralita termostática electrónica incluida (2 vías).
- Brazo a techo con rociador de ducha orientable y de acero inoxidable: 300x300 mm.
- Soporte para ducha de mano con toma de agua a pared.
- Ducha de mano anticalcárea de latón.
- Flexo satinado.



- 09286564 1.133,00
- 09286564OM 1.521,00 **N**
- 09286564OPM 1.521,00 **N**



- 09288564NM 1.234,00

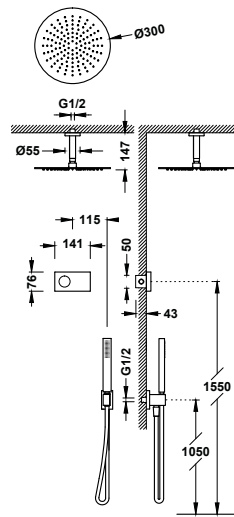

Kit de grifo termostático electrónico empotrado de 2 vías Shower Technology Blue Edition para ducha

- Control electrónico incluido con juntas antihumedad Schlüter.
- Centralita termostática electrónica incluida (2 vías).
- Brazo a techo con rociador de ducha orientable y de acero inoxidable: Ø 300 mm.
- Soporte para ducha de mano con toma de agua a pared.
- Ducha de mano anticalcárea de latón.
- Flexo satinado.



- 09286567 1.125,00
- 09286567OM 1.465,00 **N**
- 09286567OPM 1.465,00 **N**



- 09288567NM 1.190,00

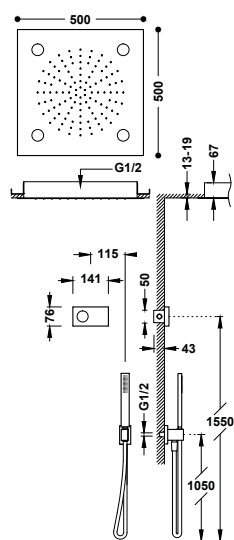

Kit de grifo termostático electrónico empotrado de 2 vías Shower Technology Blue Edition con Cromoterapia para ducha

- Control electrónico incluido con juntas antihumedad Schlüter.
- Centralita termostática electrónica incluida (2 vías).
- Rociador de ducha empotrado a techo con Cromoterapia de acero inoxidable: 500x500 mm
- Soporte para ducha de mano con toma de agua a pared.
- Ducha de mano anticalcárea de latón.
- Flexo satinado.



- 09286562 1.966,00



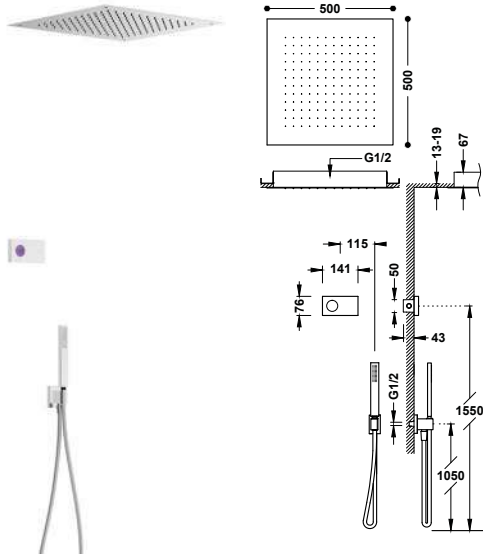

**Kit de grifo termostático electrónico empotrado de 2 vías
Shower Technology Blue Edition para ducha**

- Control electrónico incluido con juntas antihumedad Schlüter.
- Centralita termostática electrónica incluida (2 vías).
- Rociador de ducha empotrado a techo de acero inoxidable: 500x500 mm.
- Soporte para ducha de mano con toma de agua a pared.
- Ducha de mano anticalcárea de latón.
- Flexo satinado.

09286561 **1.682,00**



09288561NM **2.200,00**

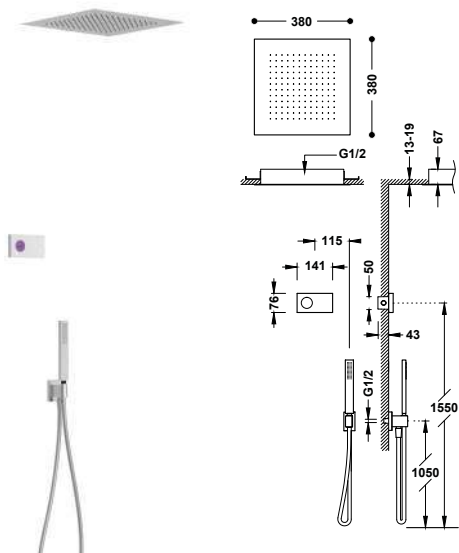

**Kit de grifo termostático electrónico empotrado de 2 vías
Shower Technology Blue Edition para ducha**

- Control electrónico incluido con juntas antihumedad Schlüter.
- Centralita termostática electrónica incluida (2 vías).
- Rociador de ducha empotrado a techo de acero inoxidable: 380x380 mm.
- Soporte para ducha de mano con toma de agua a pared.
- Ducha de mano anticalcárea de latón.
- Flexo satinado.

09286552 **1.540,00**



09288552NM **1.952,00**

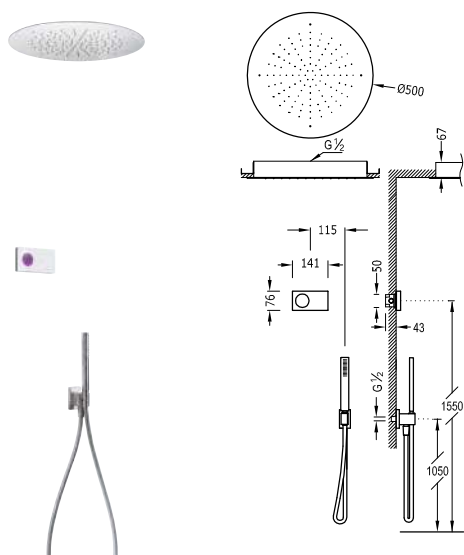

**Kit de grifo termostático electrónico empotrado de 2 vías
Shower Technology Blue Edition para ducha**

- Control electrónico incluido con juntas antihumedad Schlüter.
- Centralita termostática electrónica incluida (2 vías).
- Rociador de ducha empotrado a techo de acero inoxidable: Ø 500 mm.
- Soporte para ducha de mano con toma de agua a pared.
- Ducha de mano anticalcárea de latón.
- Flexo satinado.

09286557 **1.682,00**



09288557NM **2.190,00**



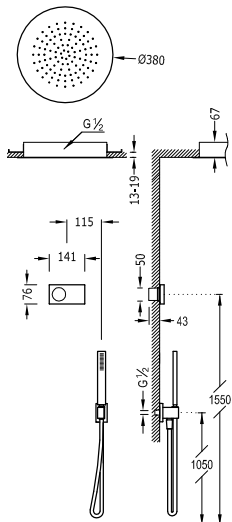

**Kit de grifo termostático electrónico empotrado de 2 vías
Shower Technology Blue Edition para ducha**

- Control electrónico incluido con juntas antihumedad Schlüter.
- Centralita termostática electrónica incluida (2 vías).
- Rociador de ducha empotrado a techo de acero inoxidable: Ø 380 mm.
- Soporte para ducha de mano con toma de agua a pared.
- Ducha de mano anticalcárea de latón.
- Flexo satinado.

09286555 **1.516,00**



09288555NM **1.942,00**



**Kit de grifo termostático electrónico empotrado de 2 vías
Shower Technology Blue Edition para bañera y ducha**

- Control electrónico incluido con juntas antihumedad Schlüter.
- Centralita termostática electrónica incluida (2 vías).
- Caño fijo de pared con salida en cascada.
- Soporte para ducha de mano con toma de agua a pared.
- Ducha de mano anticalcárea de latón.
- Flexo satinado.

09286556 **1.232,00**



09288556NM **1.502,00**

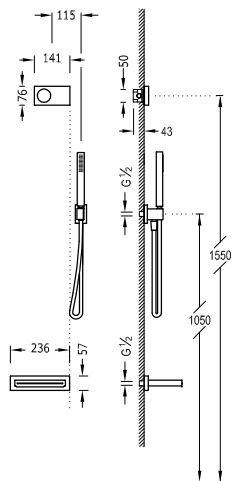

KITS DE 3 VÍAS

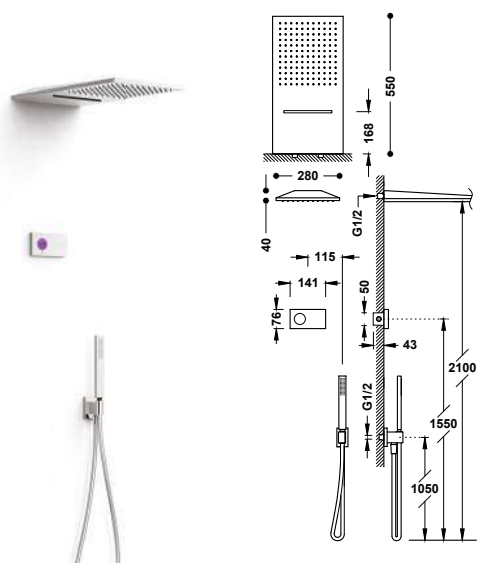

Kit de grifo termostático electrónico empotrado de 3 vías Shower Technology Blue Edition para ducha

- Control electrónico incluido con juntas antihumedad Schlüter.
- Centralita termostática electrónica incluida (3 vías).
- Rociador de ducha a pared de acero inoxidable con 2 tipos de chorro (lluvia/cascada). 280x550 mm. **IMPORTANTE:** Montar un desagüe de >50 l/min.
- Soporte para ducha de mano con toma de agua a pared.
- Ducha de mano anticalcárea de latón.
- Flexo satinado.

- 09286308 **1.534,00**
- 09286308OM **2.361,00**
- 09286308OPM **2.361,00**
- 09288308NM **1.884,00**

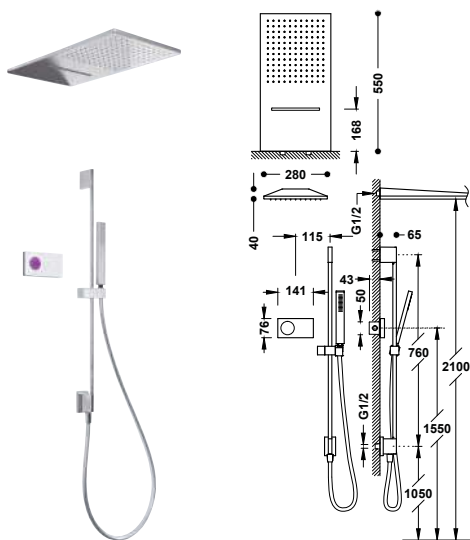

Kit de grifo termostático electrónico empotrado de 3 vías Shower Technology Blue Edition para ducha

- Control electrónico incluido con juntas antihumedad Schlüter.
- Centralita termostática electrónica incluida (3 vías).
- Rociador de ducha a pared de acero inoxidable con 2 tipos de chorro (lluvia/cascada). 280x550 mm. **IMPORTANTE:** Montar un desagüe de >50 l/min.
- Barra deslizante para ducha con toma de agua a pared.
- Ducha de mano anticalcárea de latón.
- Flexo satinado.

- 09286307 **1.598,00**

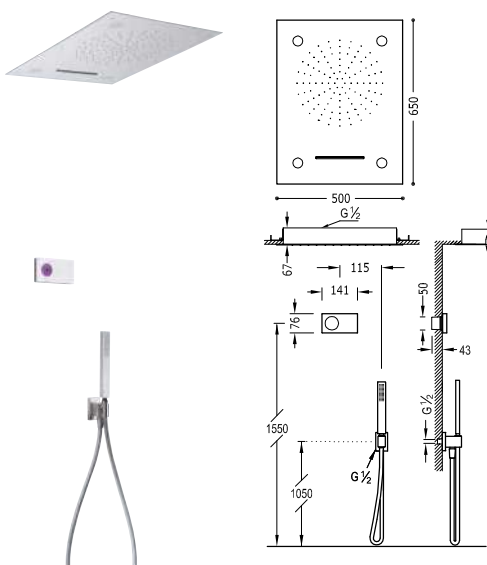

Kit de grifo termostático electrónico empotrado de 3 vías Shower Technology Blue Edition con Cromoterapia para ducha

- Control electrónico incluido con juntas antihumedad Schlüter.
- Centralita termostática electrónica incluida (3 vías).
- Rociador de ducha empotrado a techo con Cromoterapia de acero inoxidable con 2 tipos de chorro (lluvia/cascada). 500x650 mm. **IMPORTANTE:** Montar un desagüe de >50 l/min.
- Soporte para ducha de mano con toma de agua a pared.
- Ducha de mano anticalcárea de latón.
- Flexo satinado.

- 09286302 **2.862,00**



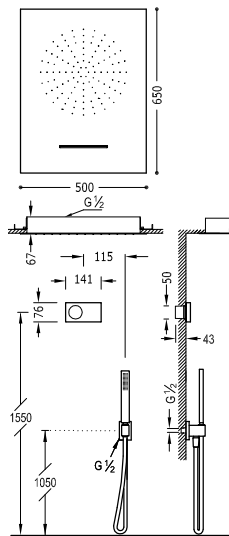

**Kit de grifo termostático electrónico empotrado de 3 vías
Shower Technology Blue Edition para ducha**

09286304

2.142,00



- Control electrónico incluido con juntas antihumedad Schlüter.
- Centralita termostática electrónica incluida (3 vías).
- Rociador de ducha empotrado a techo de acero inoxidable con 2 tipos de chorro (lluvia/cascada). 500x650 mm. IMPORTANTE: Montar un desagüe de >50 l/min.
- Soporte para ducha de mano con toma de agua a pared.
- Ducha de mano anticalcárea de latón.
- Flexo satinado.

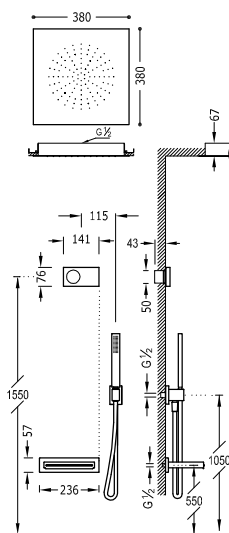

**Kit de grifo termostático electrónico empotrado de 3 vías
Shower Technology Blue Edition para bañera y ducha**

09286315

1.910,00



- Control electrónico incluido con juntas antihumedad Schlüter.
- Centralita termostática electrónica incluida (3 vías).
- Rociador de ducha empotrado a techo de acero inoxidable: 380x380 mm. IMPORTANTE: Montar un desagüe de >50 l/min.
- Caño fijo de pared con salida en cascada.
- Soporte para ducha de mano con toma de agua a pared.
- Ducha de mano anticalcárea de latón.
- Flexo satinado.



09288315NM

2.523,00



KITS DE 4 VÍAS

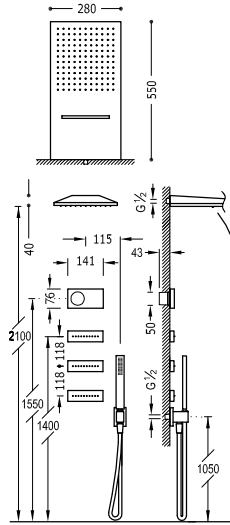

Kit de grifo termostático electrónico empotrado de 4 vías Shower Technology Blue Edition para ducha

- Control electrónico incluido con juntas antihumedad Schlüter.
- Centralita termostática electrónica incluida (4 vías).
- Rociador de ducha a pared de acero inoxidable con 2 tipos de chorro (lluvia/cascada). 280x550 mm. IMPORTANTE: Montar un desagüe de >50 l/min.
- 3 jets empotrados de hidromasaje de latón.
- Soporte para ducha de mano con toma de agua a pared.
- Ducha de mano anticalcárea de latón.
- Flexo satinado.

09286408

2.118,00



09288408NM

2.758,00

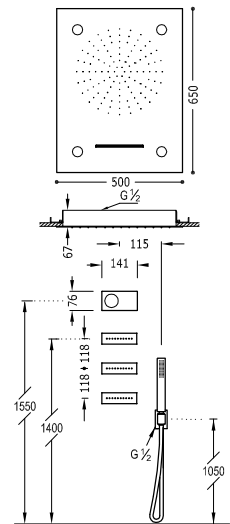

Kit de grifo termostático electrónico empotrado de 4 vías Shower Technology Blue Edition con Cromoterapia para ducha

- Control electrónico incluido con juntas antihumedad Schlüter.
- Centralita termostática electrónica incluida (4 vías).
- Rociador de ducha empotrado a techo con Cromoterapia de acero inoxidable con 2 tipos de chorro (lluvia/cascada). 500x650 mm. IMPORTANTE: Montar un desagüe de >50 l/min.
- 3 jets empotrados de hidromasaje de latón.
- Soporte para ducha de mano con toma de agua a pared.
- Ducha de mano anticalcárea de latón.
- Flexo satinado.

09286402

3.446,00

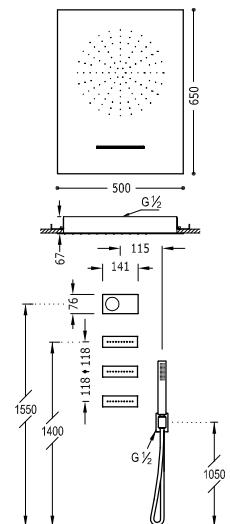

Kit de grifo termostático electrónico empotrado de 4 vías Shower Technology Blue Edition para ducha

- Control electrónico incluido con juntas antihumedad Schlüter.
- Centralita termostática electrónica incluida (4 vías).
- Rociador de ducha empotrado a techo de acero inoxidable con 2 tipos de chorro (lluvia/cascada). 500x650 mm. IMPORTANTE: Montar un desagüe de >50 l/min.
- 3 jets empotrados de hidromasaje de latón.
- Soporte para ducha de mano con toma de agua a pared.
- Ducha de mano anticalcárea de latón.
- Flexo satinado.

09286404

2.726,00



09288404NM

3.577,00



GRIFOS ELECTRÓNICOS DE 1 AGUA

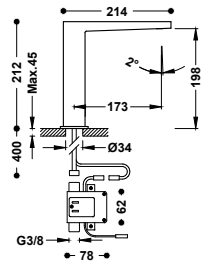

Grifo electrónico de 1 agua para lavabo
Accionado mediante sensor de infrarrojos.

- 20261310 **340,00**
- 20261310NM **527,00**
- 20261310BM **527,00**
- 20261310AC **527,00**
- 20261310OR **680,00**
- 20261310OM **680,00**

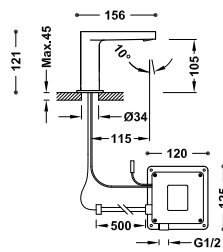

Grifo electrónico de 1 agua para lavabo
Accionado mediante sensor de infrarrojos. Caudal: 8,5 l/min.

- 20560301 **295,00**

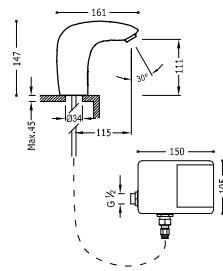

Grifo electrónico de 1 agua para lavabo
Accionado mediante sensor de infrarrojos.

- 19260603 **290,00**

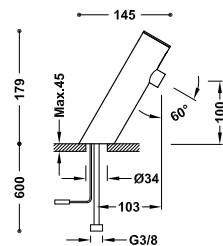

Grifo electrónico de 1 agua para lavabo
Accionado mediante sensor de infrarrojos. Caudal: 6 l/min.

- 39210302 **155,00**

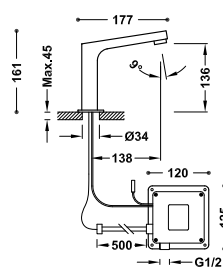

Grifo electrónico de 1 agua para lavabo
Accionado mediante sensor de infrarrojos.

- 39210307 **199,00**



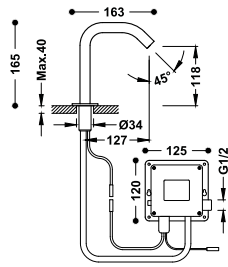

Grifo electrónico de 1 agua para lavado
Accionado mediante sensor de infrarrojos.

39210303

300,00

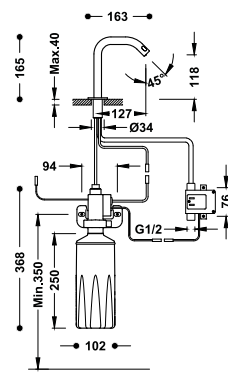

Grifo electrónico de 1 agua con dispensador de jabón automático para lavado

Accionado mediante sensor de infrarrojos. Capacidad del depósito de jabón: 1600 ml.

39210304

400,00

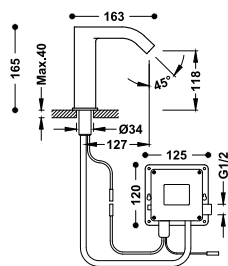

Grifo electrónico de 1 agua para lavado
Accionado mediante sensor de infrarrojos.

39210305

380,00

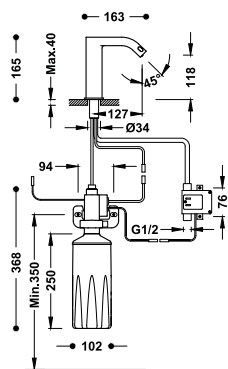

Grifo electrónico de 1 agua con dispensador de jabón automático para lavado

Accionado mediante sensor de infrarrojos. Capacidad del depósito de jabón: 1600 ml.

39210306

480,00



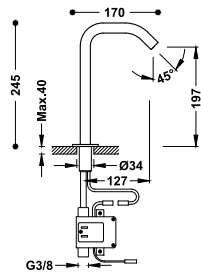

Grifo electrónico de 1 agua para lavabo
Accionado mediante sensor de infrarrojos.

39210319

390,00

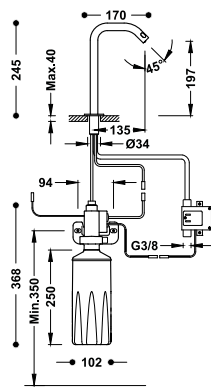

Grifo electrónico de 1 agua con dispensador de jabón automático para lavabo

Accionado mediante sensor de infrarrojos. Capacidad del depósito de jabón: 1600 ml.

39210320

490,00

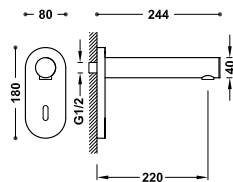

Grifo electrónico mural de 1 agua para lavabo

Accionado mediante sensor de infrarrojos. La caja de la batería está localizada dentro del mismo caño. Conexión roscada macho de G1/2.

39210308

298,00



GRIFO ELECTRÓNICO MURAL DE 1 AGUA PARA LAVABO

39210308

La caja de la batería está localizada dentro del mismo caño.
Sistema patentado.



4 x
AAA / LR06
Baterías NO incluidas
Larga duración: 8 años

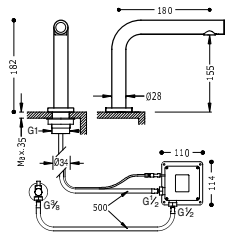

Grifo electrónico de 1 agua para lavabo
Sistema sensible al tacto TOUCH-TRES.

06144701

265,00

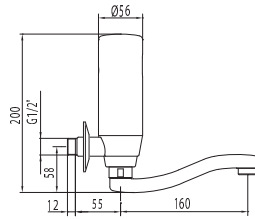

Grifo electrónico mural de 1 agua para lavabo
Accionado mediante sensor de infrarrojos.

09217101

260,00



GRIFOS ELECTRÓNICOS CON SISTEMA PREMEZCLADOR

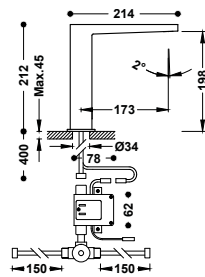

Grifo electrónico con sistema premezclador para lavabo
Accionado mediante sensor de infrarrojos. Incluye una válvula mezcladora de 2 aguas con tubos flexibles (ref. 19250730).

20261320

380,00

20261320NM

589,00

20261320BM

589,00

20261320AC

589,00

20261320OR

760,00

20261320OM

760,00

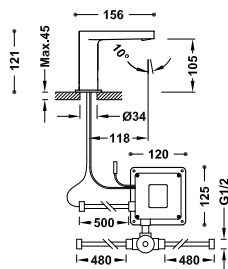

Grifo electrónico con sistema premezclador para lavabo
Accionado mediante sensor de infrarrojos. Incluye una válvula mezcladora de 2 aguas con tubos flexibles (ref. 19250730).

20560302

335,00



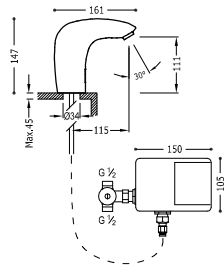

Grifo electrónico con sistema premezclador para lavabo

Accionado mediante sensor de infrarrojos. Incluye una válvula mezcladora de 2 aguas con tubos flexibles (ref.: 19250730).

19290603

330,00

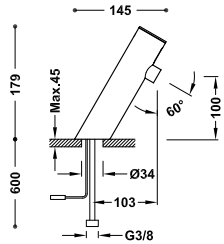

Grifo electrónico con sistema premezclador para lavabo

Accionado mediante sensor de infrarrojos. Con selector de temperatura a través de una palanca lateral. Caudal: 6 l/min.

39210301

195,00

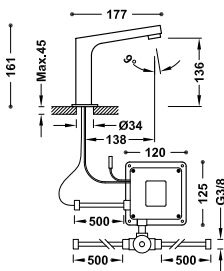

Grifo electrónico con sistema premezclador para lavabo

Accionado mediante sensor de infrarrojos. Incluye una válvula mezcladora de 2 aguas con tubos flexibles (ref.: 19250730).

39210309

239,00

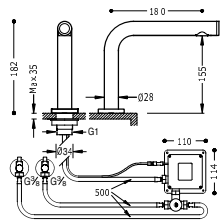

Grifo electrónico con sistema premezclador para lavabo

Sistema sensible al tacto TOUCH-TRES. Incluye una válvula mezcladora de 2 aguas con tubos flexibles (ref.: 19250730).

06144801

295,00

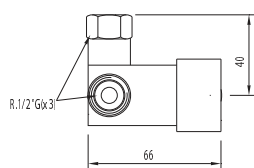

Válvula mezcladora de 2 aguas para grifo temporizado o electrónico

Apto para hacer llegar agua premezclada a un grifo de 1 agua de lavabo y cocina.

19250730

70,00

KITS DE GRIFO ELECTRÓNICO

Kit de grifo electrónico de 1 agua para lavabo

39210391

194,00

39210302 - Grifo electrónico de 1 agua para lavabo.
 134215028 - Válvula de desagüe siempre abierto para lavabo.
 134215024 - Sifón curvo articulado para lavabo.
 134215007 x 1 - Llave de escuadra con filtro.

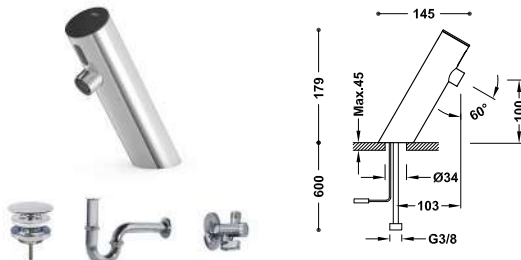

Kit de grifo electrónico con sistema premezclador para lavabo

39210390

242,00

39210301 - Grifo electrónico con sistema premezclador para lavabo.
 134215028 - Válvula de desagüe siempre abierto para lavabo.
 134215024 - Sifón curvo articulado para lavabo.
 134215007 x 2 - Llave de escuadra con filtro.

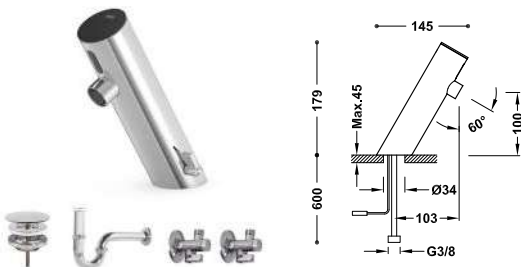

Kit de grifo electrónico de 1 agua para lavabo

39210397

238,00

39210307 - Grifo electrónico de 1 agua para lavabo.
 134215028 - Válvula de desagüe siempre abierto para lavabo.
 134215024 - Sifón curvo articulado para lavabo.
 134215007 x 1 - Llave de escuadra con filtro.

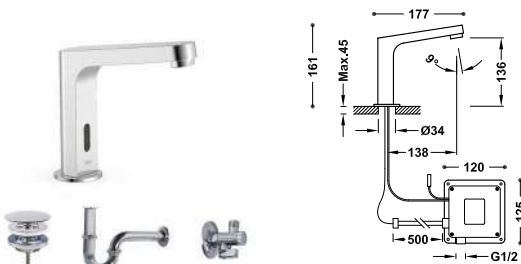

Kit de grifo electrónico con sistema premezclador para lavabo

39210399

286,00

39210309 - Grifo electrónico con sistema premezclador para lavabo.
 134215028 - Válvula de desagüe siempre abierto para lavabo.
 134215024 - Sifón curvo articulado para lavabo.
 134215007 x 2 - Llave de escuadra con filtro.

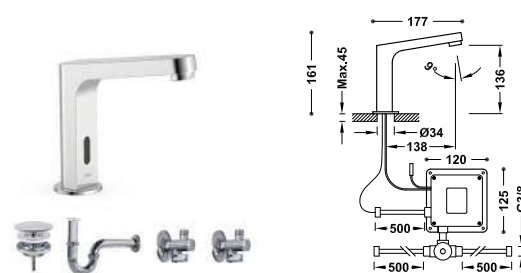

DISPENSADORES DE JABÓN

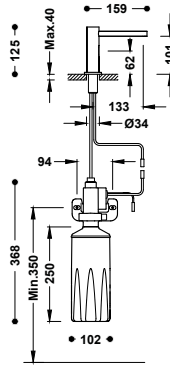

Dispensador electrónico de jabón para lavabo y cocina
 Accionado mediante sensor de infrarrojos. Capacidad del depósito de jabón: 1.600 ml.

39274101

295,00

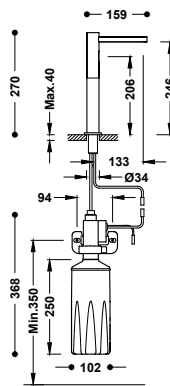

Dispensador electrónico alto de jabón para lavabo y cocina
 Accionado mediante sensor de infrarrojos. Capacidad del depósito de jabón: 1.600 ml.

39274102

300,00

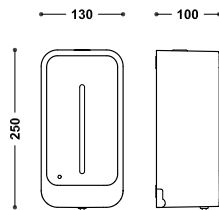

Dispensador electrónico de gel o jabón
 Accionado mediante sensor de infrarrojos. Capacidad del depósito de jabón: 1.000 ml.

01240801

65,00

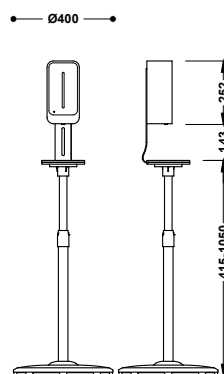

Soporte a suelo con estante y dispensador electrónico de gel o jabón

01240850

145,00

Ajustable en altura para el hogar, negocio, escuela, hotel. Capacidad del depósito de jabón: 1.000 ml.



SENSORES WC

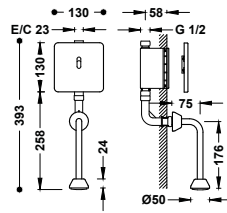

Grifo electrónico empotrado con sensor para urinario
 Accionado mediante sensor de infrarrojos. Con un tubo adaptable a urinario. Material: Acero inoxidable.

01220702

210,00

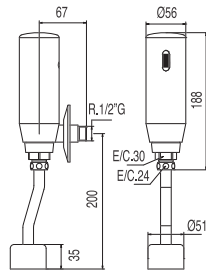

Grifo de descarga electrónico mural de 1 agua para urinario
 Accionado mediante sensor de infrarrojos. Con dos tubos adaptables a urinario.

112206

275,00

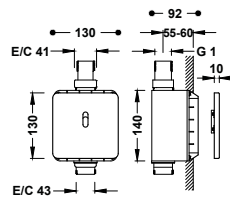

Grifo electrónico empotrado con sensor para váter
 Accionado mediante sensor de infrarrojos. Material: Acero inoxidable.

01221701

298,00



SECADOR DE MANOS

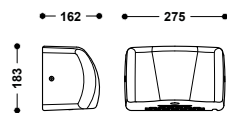

Secador de manos automático por aire caliente
 Accionado mediante sensor de infrarrojos.

39274201

192,00

39274201AC

192,00

39274201BL

192,00



COCINA ELECTRÓNICA

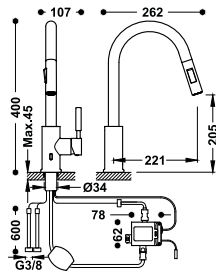

Grifo electrónico con caño extraíble y 2 tipos de chorro para cocina

09244501AC **335,00**

Accionado mediante sensor de infrarrojos. Con regulador de caudal y temperatura a través de una maneta lateral. Material: Acero inoxidable.

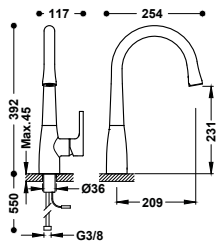

Grifo electrónico para cocina

09244601 **300,00**

Accionado mediante sensor de infrarrojos situado detrás de la salida del agua. Con regulador de caudal y temperatura a través de una maneta lateral.

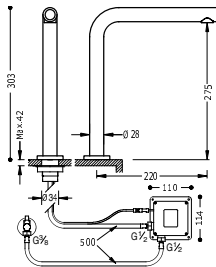

Grifo electrónico de 1 agua para cocina

161445 **316,00**

Sistema sensible al tacto TOUCH-TRES. Con latiguillos de alimentación flexible G3/8.

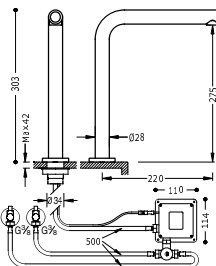

Grifo electrónico con sistema premezclador para cocina

161446 **366,00**

Sistema sensible al tacto TOUCH-TRES. Incluye una válvula mezcladora de 2 aguas con tubos flexibles (ref.: 19250730). Con latiguillos de alimentación flexible G3/8.



ESPACIO DE COCINA



































Monomandos	444
A muro	454
Con caño flexible	457
Para tratamiento de agua	458
Con caño extraíble	460
Con caño abatible	462
Bimandos	462
Industriales	466
Electrónicos	468
Grifos para varios usos	469



Referencia	Página	Acabados disponibles	Tecnología	Certificados	Altura (mm)
MONOMANDOS					
	106486	444			300
	106440	444			270
	130496	444			305
	130497	444			367
	130498	444			367
	06248801	445			296
	20548601	445			300
	20044001	445			300
	162435	445			310
	162541	446			350
	162441	446			376
	130336	446			286

Referencia	Página	Acabados disponibles	Tecnología	Certificados	Altura (mm)
	162436	446			304
	181436	445			304
	20044002	447			418
	06254201 20544001	447 446			418
	162540	447			450
	181540	447			417
	162440	448			426
	162442	447			350
	181341 183341	448			351
	24234101	448			293
	24244101	448			268
	06944701 172447 17044702	450 449			352

Referencia	Página	Acabados disponibles	Tecnología	Certificados	Altura (mm)
 21644010	450				378
 21644020	450		 	 	378
 21644710	449				338
 21644720	449		 		338
 06944001	449		 		330
 169440 117440	450				380
 17044102	451				260
 139441	451			 	260
 21544101	451				264
 172440 17044002	451 452				233
 07044802	452				261
 08333301	451				300

Referencia	Página	Acabados disponibles	Tecnología	Certificados	Altura (mm)
 117333	453			 	180
 17033302	452			 	178
 130337	453				180
 21533301 172333	452				180

A MURO



 172317 172318	454				283* 273*
 17032002 17041802 07032003	454				273* 233* 203*
 21632010 21632020 21632030	455				168* 228* 268*
 172418 172218	455 456				272*
 17021802 17031802	456				272*
 21642010	456				264*
 172420	455				293*
 17033202	456				293*



ESPACIO DE COCINA

Referencia	Página	Acabados disponibles	Tecnología	Certificados	Altura (mm)
------------	--------	----------------------	------------	--------------	-------------

CAÑO FLEXIBLE

	00648701	457			455
	20548702	457			455
	03048701 06248702	457			455

CAÑO EXTRAÍBLE

	106437	460		 	300
	162438 181438	460			315
	162437	460			293
	181437	460			293
	114444	461			370
	06944401 03944401 03044401	461			300
	03043801	462			413
	03043401	461			294

Referencia	Página	Acabados disponibles	Tecnología	Certificados	Altura (mm)
------------	--------	----------------------	------------	--------------	-------------

INDUSTRIAL

	130495	466			760
	130484	466			294
	03048501	467			548
	03049301	467			564
	130481	466			1200

ELECTRÓNICA

	09244501AC	468		 	400
	09244601	468		 	392
	161445 161446	468		  	303

ABATIBLE

	130335	462		  	256
	24233401	462			293

Referencia	Página	Acabados disponibles	Tecnología	Certificados	Altura (mm)
------------	--------	----------------------	------------	--------------	-------------







PARA TRATAMIENTO DEL AGUA

	162453	459			304
	162456	459			304
	03035501	459			375
	03045501	459			375







BIMANDO

	163333	462			427
	24234201	462			256
	24221501	463			284*
	24231001	463			283*
	123342	463			286
	123310 123210	463			270*
	123214 123215 123230	464			219* 269* 369*

Referencia	Página	Acabados disponibles	Tecnología	Certificados	Altura (mm)
------------	--------	----------------------	------------	--------------	-------------

	123314 123315 123330 123360	464 465			219* 269* 369* 429*
	123416	465			309*
	123317 123217	465			289*

1 AGUA

	123306	469			265
	123505	469			298*
	123506	469			248*

* Longitud del caño



MONOMANDOS

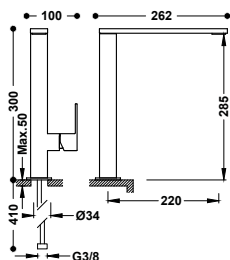

Grifo monomando para cocina
Con latiguillos de alimentación flexibles G3/8.

- 106486 **400,00**
- 006486NM **620,00**
- 006486BM **620,00**
- 50648603 **620,00**
- 0064860M **800,00**

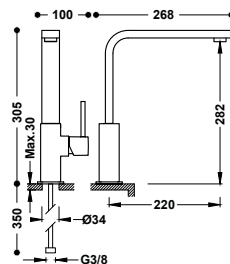

Grifo monomando para cocina
Con latiguillos de alimentación flexibles G3/8.

- 130496 **295,00**
- 030496NM **457,00**
- 030496BM **457,00**
- 53049603 **457,00**
- 0304960M **590,00**

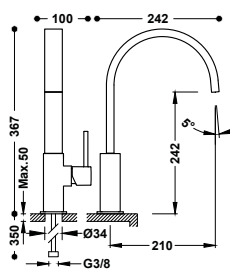

Grifo monomando para cocina
Con latiguillos de alimentación flexibles G3/8.

- 130498 **300,00**
- 030498NM **465,00**
- 030498BM **465,00**
- 53049803 **465,00**
- 0304980M **600,00**

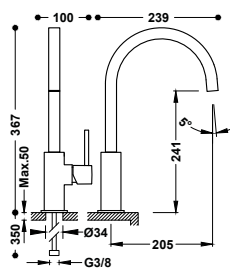

Grifo monomando para cocina
Con latiguillos de alimentación flexibles G3/8.

- 130497 **295,00**
- 030497NM **457,00**
- 030497BM **457,00**
- 53049703 **457,00**
- 0304970M **590,00**

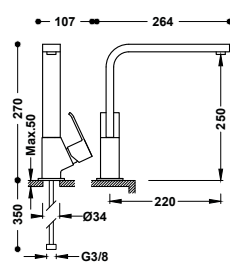

Grifo monomando para cocina
Con latiguillos de alimentación flexibles G3/8.

- 106440 **352,00**



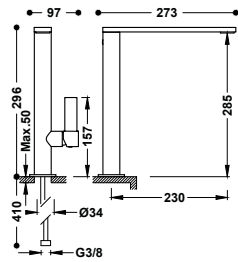

Grifo monomando para cocina
Con latiguillos de alimentación flexibles G3/8.



20548601 **245,00**

20548601NM **380,00**

20548601BM **380,00**

20548601AC **380,00**

20548601OM **490,00**

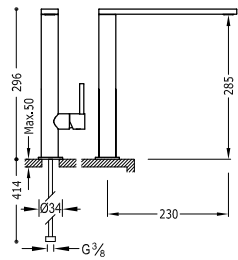

Grifo monomando para cocina
Con latiguillos de alimentación flexibles G3/8.



06248801 **240,00**

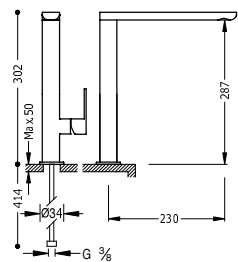

Grifo monomando para cocina
Con latiguillos de alimentación flexibles G3/8.



20044001 **250,00**

20044001NM **388,00**

20044001BM **388,00**

20044001AC **388,00**

20044001OM **500,00**

20044001NE **388,00**

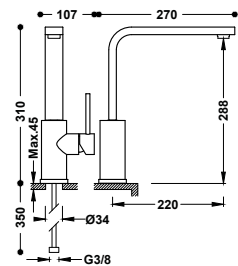

Grifo monomando para cocina
Con latiguillos de alimentación flexibles G3/8.



162435 **260,00**

062435NM **403,00**

062435BM **403,00**

062435AC **403,00**

062435OM **520,00**

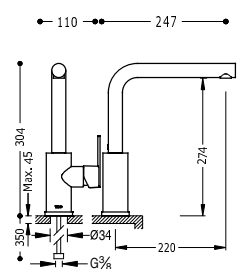

Grifo monomando para cocina
Con latiguillos de alimentación flexibles G3/8.



181436 **200,00**



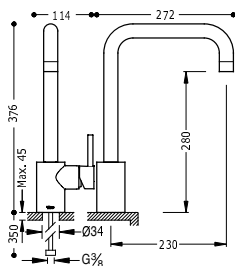

Grifo monomando para cocina
Con latiguillos de alimentación flexibles G3/8.

162441

198,00



9134290

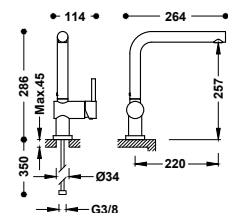

Grifo monomando para cocina
Con latiguillos de alimentación flexibles G3/8.

130336

234,00

030336BM

363,00

030336AC

363,00



9134288

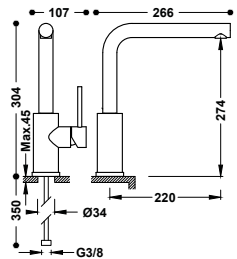

Grifo monomando para cocina
Con latiguillos de alimentación flexibles G3/8.

162436

225,00

06243601NM

349,00

06243601BM

349,00

06243601AC

349,00

06243601OM

450,00



9134592

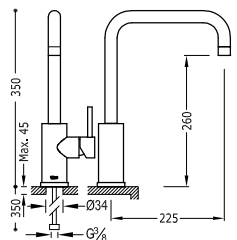

Grifo monomando para cocina
Con latiguillos de alimentación flexibles G3/8.

162541

270,00



9134592

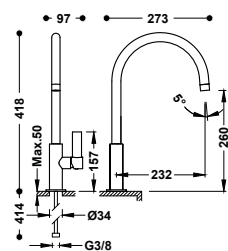

Grifo monomando para cocina
Con latiguillos de alimentación flexibles G3/8.

20544001

220,00

20544001NM

341,00

20544001BM

341,00

20544001AC

341,00

20544001OM





440,00

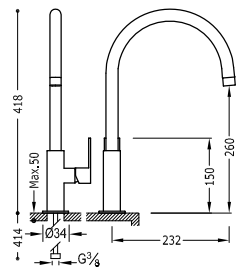

9130190





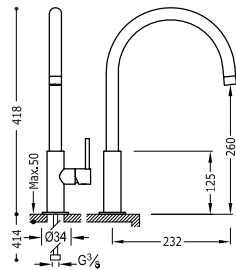

Grifo monomando para cocina
Con latiguillos de alimentación flexibles G3/8.

-  20044002 **225,00**
-  20044002NM **349,00**
-  20044002BM **349,00**
-  20044002AC **349,00**



Grifo monomando para cocina
Con latiguillos de alimentación flexibles G3/8.

-  06254201 **215,00**
-  06254201NM **333,00**
-  06254201BM **333,00**
-  06254201AC **333,00**
-  06254201OM **430,00**

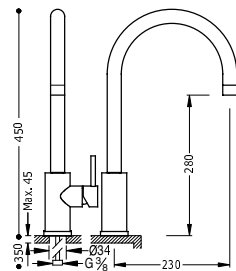

Grifo monomando para cocina
Con latiguillos de alimentación flexibles G3/8.

-  162540 **235,00**

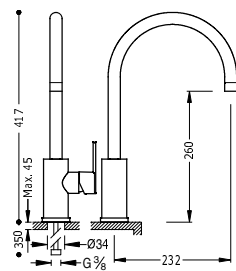

Grifo monomando para cocina
Con latiguillos de alimentación flexibles G3/8.

-  181540 **220,00**

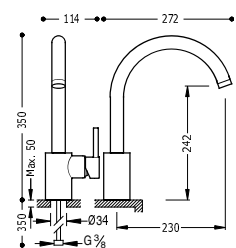

Grifo monomando para cocina
Con latiguillos de alimentación flexibles G3/8.

-  162442 **174,00**



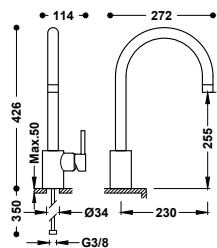

Grifo monomando para cocina
Con latiguillos de alimentación flexibles G3/8.

162440 **195,00**

56244003 **302,00**



9134290

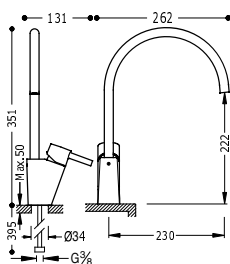

Grifo monomando para cocina
Con latiguillos de alimentación flexibles G3/8.

183341 **142,00**



9134592

I

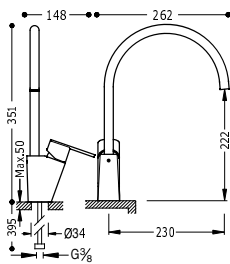

Grifo monomando para cocina
Con latiguillos de alimentación flexibles G3/8.

181341 **150,00**



9134592

I

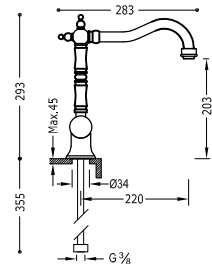

Grifo monomando para cocina
Con latiguillos de alimentación flexibles G3/8.

24234101 **312,00**

24234101AC **484,00**

24234101OR **624,00**

24234101LV **437,00**

24234101LM **437,00**



9134591

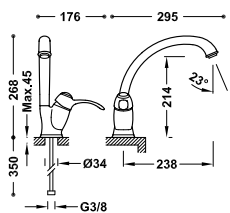

Grifo monomando para cocina
Con latiguillos de alimentación flexibles G3/8.

24244101 **238,00**

24244101AC **369,00**

24244101OR **476,00**

24244101LV **333,00**

24244101LM **333,00**



9134592

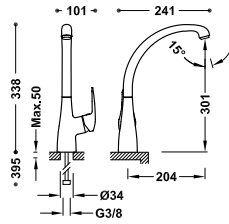

Grifo monomando para cocina
Con latiguillos de alimentación flexibles G3/8.

21644710

74,50



29903504

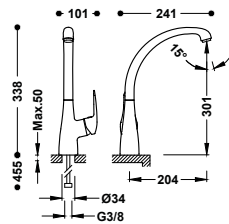

Grifo monomando para cocina
Con latiguillos de alimentación flexibles G3/8.

21644720

80,50



IIA

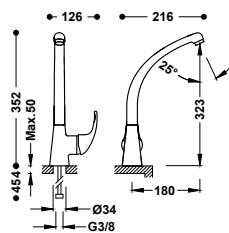

Grifo monomando para cocina
Con latiguillos de alimentación flexibles G3/8.

172447

98,50

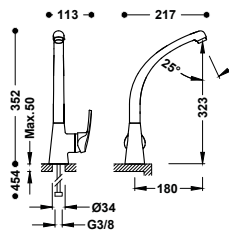

Grifo monomando para cocina
Con latiguillos de alimentación flexibles G3/8.

17044702

98,50

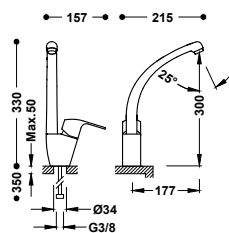

Grifo monomando para cocina
Con latiguillos de alimentación flexibles G3/8.

06944001

100,00



913427010

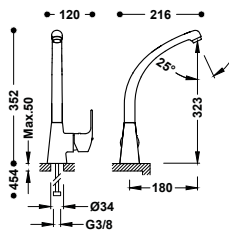

Grifo monomando para cocina
Con latiguillos de alimentación flexibles G3/8.

06944701

98,50



9134288

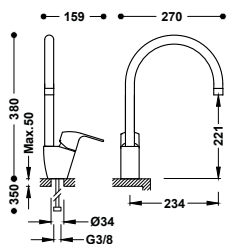

Grifo monomando para cocina
Con latiguillos de alimentación flexibles G3/8.

169440

106,00



913429510

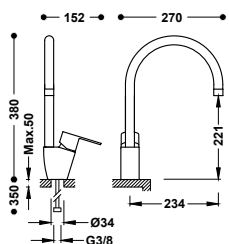

Grifo monomando para cocina
Con latiguillos de alimentación flexibles G3/8.

117440

106,00



913429510

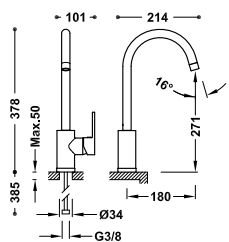

Grifo monomando para cocina
Con latiguillos de alimentación flexibles G3/8.

21644010

79,00



29903504

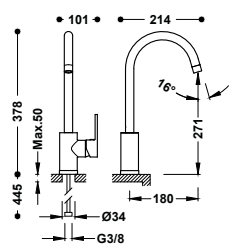

Grifo monomando para cocina
Con latiguillos de alimentación flexibles G3/8.

21644020

85,00



IIA

I

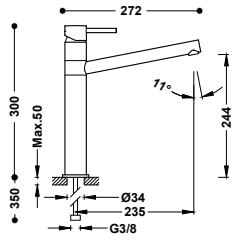

Grifo monomando para cocina
Con latiguillos de alimentación flexibles G3/8.

08333301 **164,00**

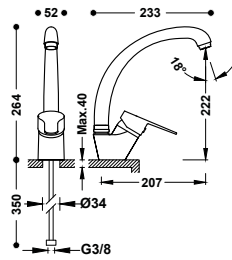

Grifo monomando para cocina
Con latiguillos de alimentación flexibles G3/8.

21544101 **68,00**

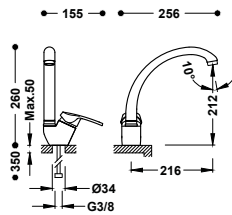

Grifo monomando para cocina
Con latiguillos de alimentación flexibles G3/8.

17044102 **72,50**

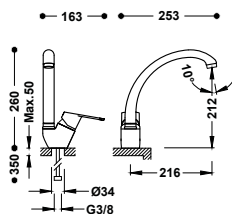

Grifo monomando para cocina
Con latiguillos de alimentación flexibles G3/8.

139441 **82,50**

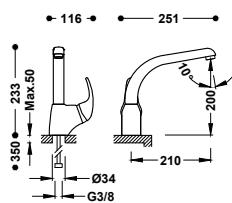

Grifo monomando para cocina
Con latiguillos de alimentación flexibles G3/8.

172440 **110,00**



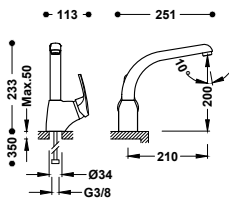

Grifo monomando para cocina
Con latiguillos de alimentación flexibles G3/8.

17044002 **105,00**

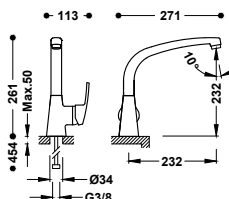

Grifo monomando para cocina
Con latiguillos de alimentación flexibles G3/8.

07044802 **105,00**

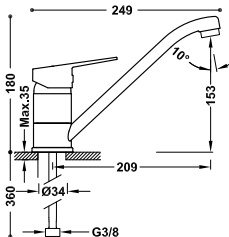

Grifo monomando para cocina
Con latiguillos de alimentación flexibles G3/8.

21533301 **62,00**

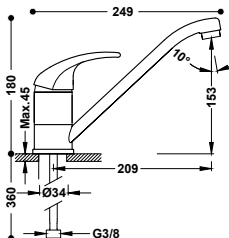

Grifo monomando para cocina
Con latiguillos de alimentación flexibles G3/8.

172333 **80,00**

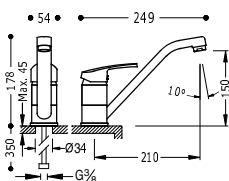

Grifo monomando para cocina
Con latiguillos de alimentación flexibles G3/8.

17033302 **82,00**



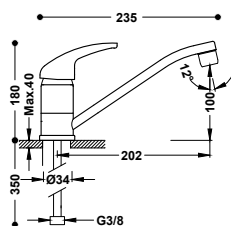

Grifo monomando para cocina
Con latiguillos de alimentación flexibles G3/8.

130337

60,50

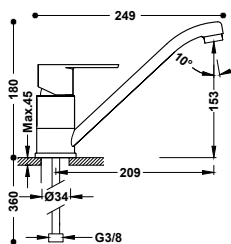

Grifo monomando para cocina
Con latiguillos de alimentación flexibles G3/8.

117333

92,00



913438510

IB



A MURO

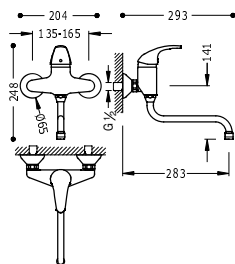

Grifo monomando mural para cocina
Con caño inferior. Distancia a pared: 283 mm.

172317

105,00

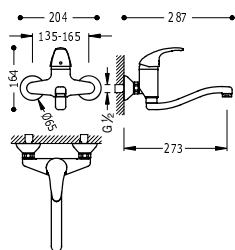

Grifo monomando mural para cocina
Con caño inferior. Distancia a pared: 273 mm.

172318

115,00

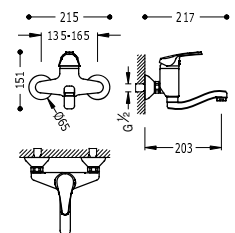

Grifo monomando mural para cocina
Con caño inferior. Distancia a pared: 203 mm.

07032003

96,00

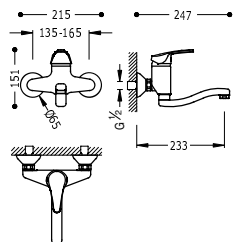

Grifo monomando mural para cocina
Con caño inferior. Distancia a pared: 233 mm.

17041802

98,00

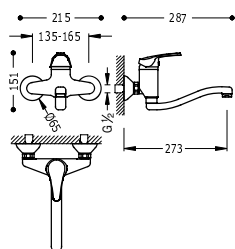

Grifo monomando mural para cocina
Con caño inferior. Distancia a pared: 273 mm.

17032002

100,00



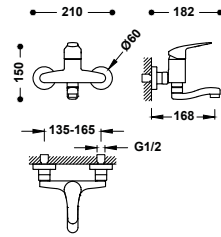

Grifo monomando mural para cocina
Con caño inferior. Distancia a pared: 168 mm.

21632010

80,00

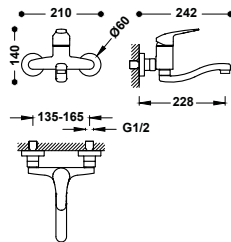

Grifo monomando mural para cocina
Con caño inferior. Distancia a pared: 228 mm.

21632020

82,00

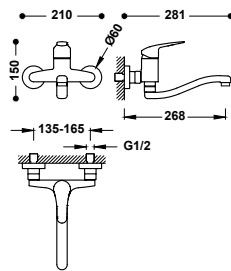

Grifo monomando mural para cocina
Con caño inferior. Distancia a pared: 268 mm.

21632030

84,00

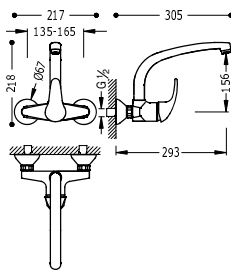
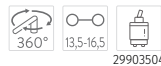

Grifo monomando mural para cocina
Con caño superior. Distancia a pared: 293 mm.

172420

115,00

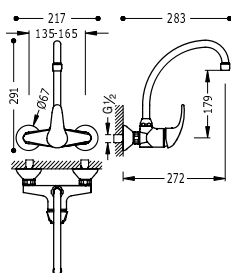

Grifo monomando mural para cocina
Con caño superior. Distancia a pared: 272 mm.

172418

95,00



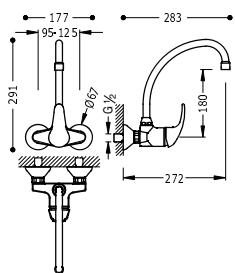

Grifo monomando mural para cocina

Con caño superior. Excentricidad especial. Distancia a pared: 272 mm.

172218

105,00

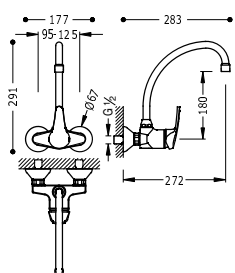

Grifo monomando mural para cocina

Con caño superior. Excentricidad especial. Distancia a pared: 272 mm.

17021802

94,00

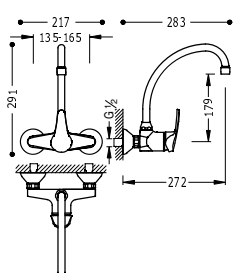
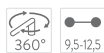

Grifo monomando mural para cocina

Con caño superior. Distancia a pared: 272 mm.

17031802

99,00

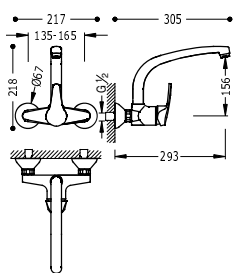

Grifo monomando mural para cocina

Con caño superior. Distancia a pared: 293 mm.

17033202

115,00

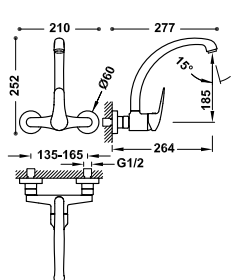

Grifo monomando mural para cocina

Con caño superior. Distancia a pared: 264 mm.

21642010





85,00

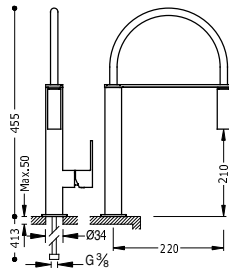

CON CAÑO FLEXIBLE





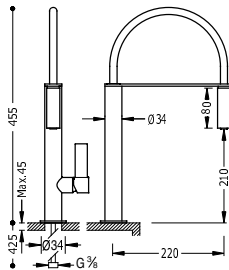

Grifo monomando con caño flexible para cocina
Con latiguillos de alimentación flexible G3/8.

-  00648701 **475,00**
-  00648701NM **736,00**
-  00648701BM **736,00**
-  00648701AC **736,00**



Grifo monomando con caño flexible para cocina
Con latiguillos de alimentación flexible G3/8.

-  20548702 **425,00**
-  20548702NM **659,00**
-  20548702BM **659,00**
-  20548702AC **659,00**

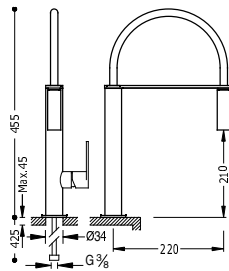

Grifo monomando con caño flexible para cocina
Con latiguillos de alimentación flexible G3/8.

-  03048701 **430,00**

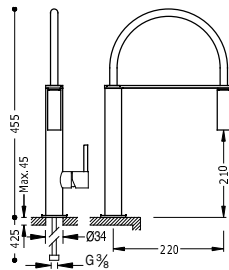

Grifo monomando con caño flexible para cocina
Con latiguillos de alimentación flexible G3/8.

-  06248702 **420,00**



Filtro anticloro

Agua de red y agua purificada en un mismo grifo



Convierte el agua del grifo en agua recién filtrada con buen sabor inmediatamente.



Elimina el mal sabor que produce el cloro pero respetando las propiedades minerales del agua de red.



Evita tener que cargar con botellas de agua, reduciendo el impacto medioambiental.



Agua filtrada hasta 4000 litros. El filtro se sustituye fácilmente sin necesidad de cortar el flujo del agua.

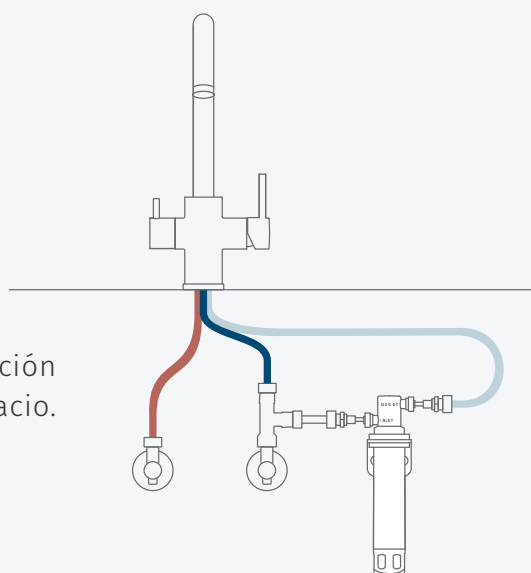

Mínima instalación en el mínimo espacio.



1 62 453

El cierre está incorporado justo en la salida del agua, eliminando el contacto del agua con el aire, evitando su contaminación.



030 355 01

Funciona con dos mandos convencionales, haciendo más cómodo su manejo.

PARA TRATAMIENTO DE AGUA

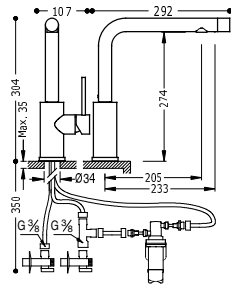

Grifo monomando doble para agua de red y filtrada para cocina

162453

306,00

Con filtro anticloro incorporado. Cierre y regulación de caudal independientes. 4.000 litros de agua sin cloro. Elimina el cloro y los compuestos orgánicos volátiles. No elimina la cal ni los minerales del agua. Latiguillos de alimentación flexible G3/8.



9134592

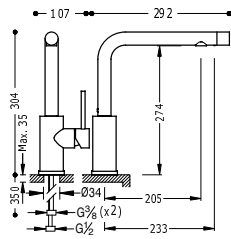

Grifo monomando doble para agua de red y filtrada para cocina

162456

280,00

Sin filtro anticloro. Cierre y regulación de caudal independientes. Grifo adaptable a instalaciones con tratamiento de agua. Latiguillos de alimentación flexible G3/8.



9134592

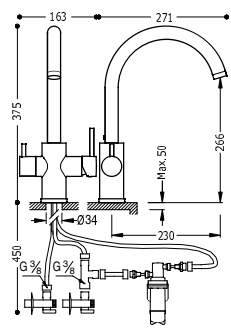

Grifo monomando doble para agua de red y filtrada para cocina

03035501

300,00

Con filtro anticloro incorporado. Cierre y regulación de caudal independientes. 4.000 litros de agua sin cloro. Elimina el cloro y los compuestos orgánicos volátiles. No elimina la cal ni los minerales del agua. Latiguillos de alimentación flexible G3/8.



9134592

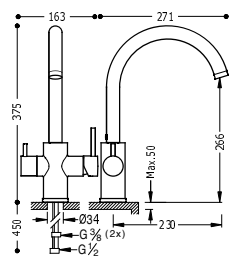

Grifo monomando doble para agua de red y filtrada para cocina

03045501

240,00

Sin filtro anticloro. Cierre y regulación de caudal independientes. Grifo adaptable a instalaciones con tratamiento de agua. Latiguillos de alimentación flexible G3/8.



9134592

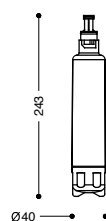

Filtro anticloro para modelos posteriores al año 2010

16235590

60,00

Solo filtro. Conexiones no incluidas.



CON CAÑO EXTRAÍBLE

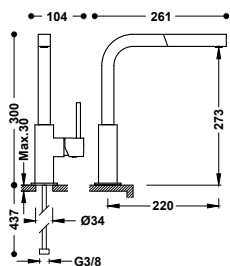

Grifo monomando con caño extraíble para cocina
Con latiguillos de alimentación flexible G3/8.

- 106437 **405,00**
- 006437NM **628,00**
- 006437BM **628,00**
- 50643703 **628,00**
- 0064370M **810,00**

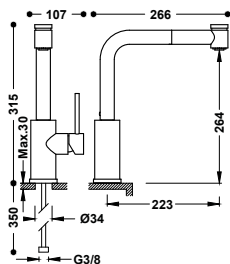

Grifo monomando con caño extraíble con 2 tipos de chorro para cocina
Con latiguillos de alimentación flexible G3/8.

- 162438 **265,00**

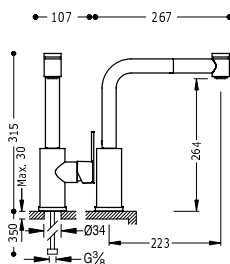

Grifo monomando con caño extraíble con 2 tipos de chorro para cocina
Con latiguillos de alimentación flexible G3/8.

- 181438 **245,00**

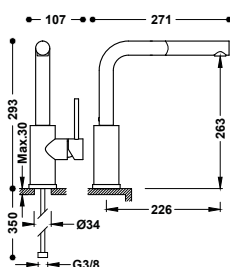
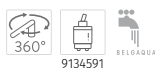

Grifo monomando con caño extraíble para cocina
Con latiguillos de alimentación flexible G3/8.

- 162437 **260,00**
- 56243703 **403,00**

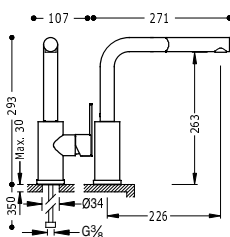

Grifo monomando con caño extraíble para cocina
Con latiguillos de alimentación flexible G3/8.

- 181437 **240,00**



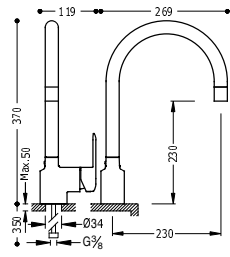

Grifo monomando con caño extraíble para cocina
Con latiguillos de alimentación flexible G3/8.

114444

305,00



9134288

BELOAGUA

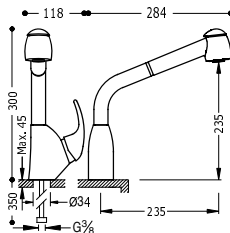

Grifo monomando con caño extraíble con 2 tipos de chorro para cocina
Con latiguillos de alimentación flexibles G3/8.

03044401

198,00



360°

BELOAGUA

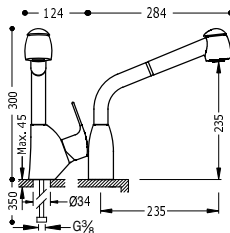

Grifo monomando con caño extraíble con 2 tipos de chorro para cocina
Con latiguillos de alimentación flexibles G3/8.

06944401

198,00



360°

9134288

BELOAGUA

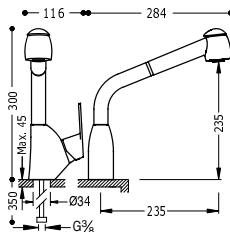

Grifo monomando con caño extraíble con 2 tipos de chorro para cocina
Con latiguillos de alimentación flexibles G3/8.

03944401

198,00



360°

9134288

BELOAGUA

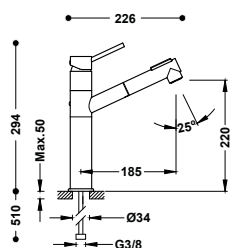

Grifo monomando con caño extraíble con 2 tipos de chorro para cocina
Con latiguillos de alimentación flexibles G3/8.

03043401

178,00



100°

29903507



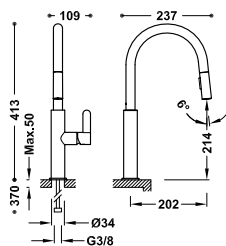

Grifo monomando con caño extraíble con 2 tipos de chorro para cocina
 Con latiguillos de alimentación flexibles G3/8.

03043801

182,00



CON CAÑO ABATIBLE

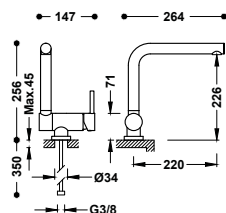

Grifo monomando con caño abatible para cocina
 Con latiguillos de alimentación flexible G3/8.

130335

248,00

- 030335NM **384,00**
- 030335BM **384,00**
- 030335AC **384,00**
- 030335OM **496,00**



913438510

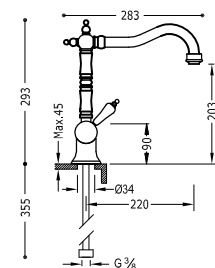

Grifo monomando con caño abatible para cocina
 Con latiguillos de alimentación flexible G3/8.

24233401

395,00

- 24233401AC **612,00**
- 24233401OR **790,00**
- 24233401LV **553,00**
- 24233401LM **553,00**



9134591

BIMANDOS

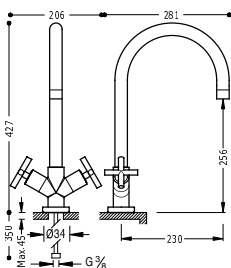

Grifo bimando para cocina
 Con latiguillos de alimentación flexible G3/8.

163333

295,00

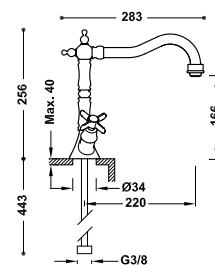

Grifo bimando para cocina
 Con latiguillos de alimentación flexible G3/8.

24234201

230,00

- 24234201AC **357,00**
- 24234201OR **460,00**
- 24234201LV **322,00**
- 24234201LM **322,00**



9134282

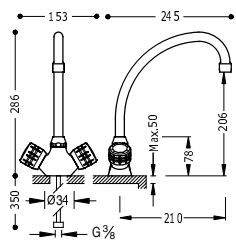

Grifo bimando para cocina

Con latiguillos de alimentación flexibles G3/8.

123342

73,00

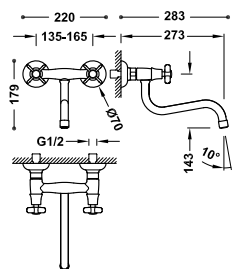

Grifo bimando mural para cocina

Con caño inferior. Distancia a pared: 273 mm.

24231001

225,00

24231001AC

349,00

24231001LV

315,00

24231001LM

315,00

24231001OR

450,00

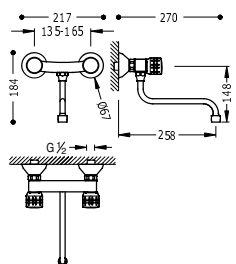

Grifo bimando mural para cocina

Con caño inferior. Distancia a pared: 258 mm.

123310

72,50

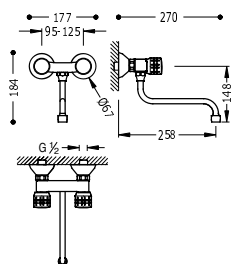

Grifo bimando mural para cocina

Con caño inferior. Excentricidad especial. Distancia a pared: 258 mm.

123210

71,50

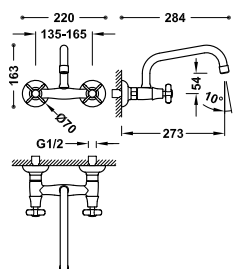

Grifo bimando mural para cocina

Con caño superior. Distancia a pared: 273 mm.

24221501

230,00

24221501AC

357,00

24221501LV

322,00

24221501LM

322,00

24221501OR

460,00



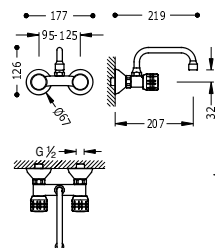

Grifo bimando mural para cocina

Con caño superior. Excentricidad especial. Distancia a pared: 207 mm.

123214

71,50

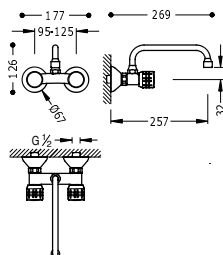

Grifo bimando mural para cocina

Con caño superior. Excentricidad especial. Distancia a pared: 257 mm.

123215

72,50

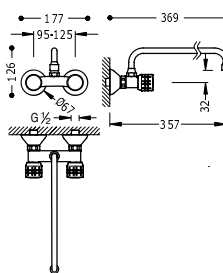

Grifo bimando mural para cocina

Con caño superior. Excentricidad especial. Distancia a pared: 357 mm.

123230

76,50

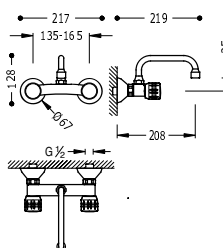

Grifo bimando mural para cocina

Con caño superior. Distancia a pared: 208 mm.

123314

72,00

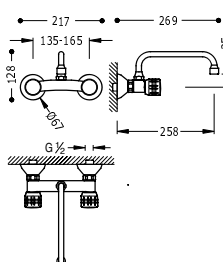

Grifo bimando mural para cocina

Con caño superior. Distancia a pared: 258 mm.

123315

73,00



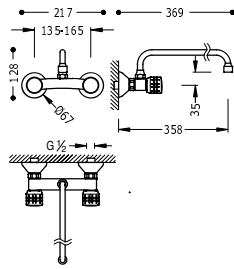

Grifo bimando mural para cocina
Con caño superior. Distancia a pared: 358 mm.

123330

77,00

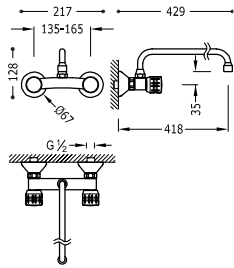

Grifo bimando mural para cocina
Con caño superior. Distancia a pared: 418 mm.

123360

81,00

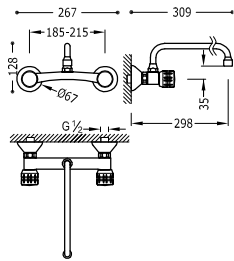

Grifo bimando mural para cocina
Con caño superior. Excentricidad especial. Distancia a pared: 298 mm.

123416

90,00

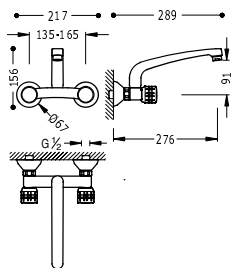

Grifo bimando mural para cocina
Con caño superior. Distancia a pared: 276 mm.

123317

94,00

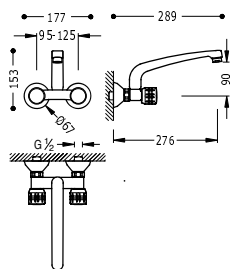

Grifo bimando mural para cocina
Con caño superior. Excentricidad especial. Distancia a pared: 276 mm.

123217

92,00

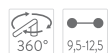

INDUSTRIALES

Grifo monomando doble con ducha extraíble para cocina industrial

130495

442,00

Con latiguillos de alimentación flexibles G3/8.

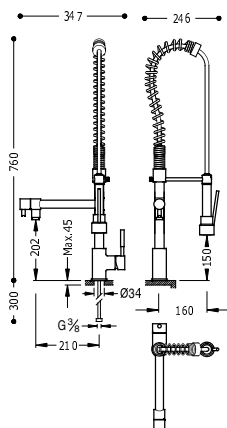

Grifo monomando con ducha extraíble para cocina industrial

130484

315,00

Con latiguillos de alimentación flexibles G3/8.

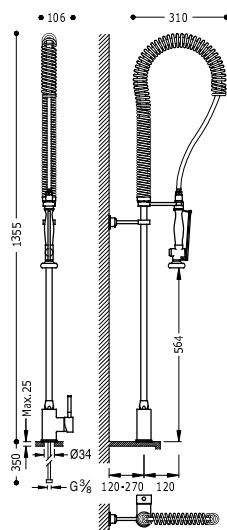

Ducha extraíble para cocina industrial con toma de agua a superficie de fregadero

130481

270,00

Sin complementos. A completar con un grifo de pedal o grifo monomando empotrado.

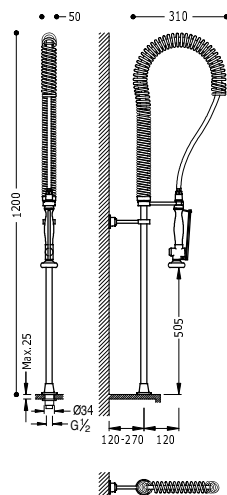

Grifo monomando con ducha extraíble con 2 tipos de chorro para cocina industrial

03048501

294,00

Con latiguillos de alimentación flexibles G3/8.

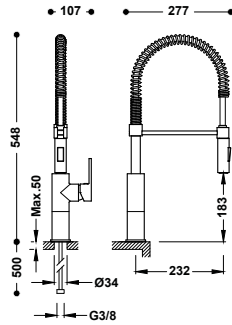

Grifo monomando con ducha extraíble con 2 tipos de chorro para cocina industrial

03049301

284,00

Con latiguillos de alimentación flexibles G3/8.

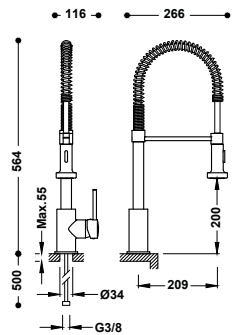

Caño giratorio para grifo de pedal

112441

38,50

Con enlace.

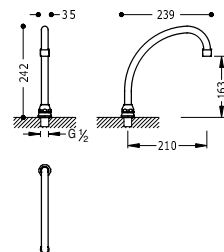

Grifo de pedal con mezclador de 2 aguas

112370

227,00

Presionando el pedal aumenta progresivamente la temperatura del agua, siempre con un caudal constante.

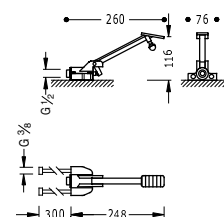

ELECTRÓNICOS

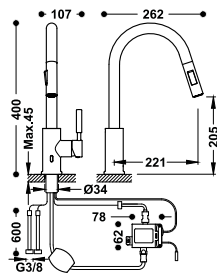

Grifo electrónico con caño extraíble y 2 tipos de chorro para cocina

Accionado mediante sensor de infrarrojos. Con regulador de caudal y temperatura a través de una maneta lateral. Material: Acero inoxidable.

09244501AC

335,00

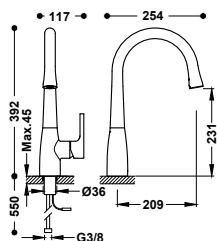

Grifo electrónico para cocina

Accionado mediante sensor de infrarrojos situado detrás de la salida del agua. Con regulador de caudal y temperatura a través de una maneta lateral.

09244601

300,00

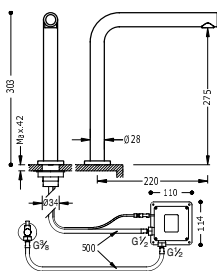

Grifo electrónico de 1 agua para cocina

Sistema sensible al tacto TOUCH-TRES. Con latiguillos de alimentación flexible G3/8.

161445

316,00

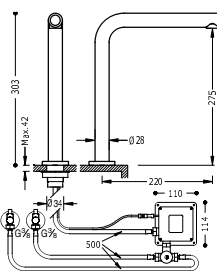

Grifo electrónico con sistema premezclador para cocina

Sistema sensible al tacto TOUCH-TRES. Incluye una válvula mezcladora de 2 aguas con tubos flexibles (ref.: 19250730). Con latiguillos de alimentación flexible G3/8.

161446

366,00



GRIFOS PARA VARIOS USOS

Grifo de 1 agua con volante lateral para office o lavadero
Con latiguillo de alimentación flexible G3/8.

123306

50,00

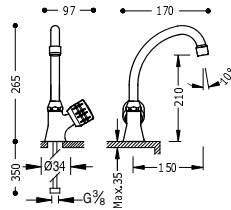

Grifo mural de 1 agua para office o lavadero
Con caño inferior. Distancia a pared: 287 mm.

123505

38,50

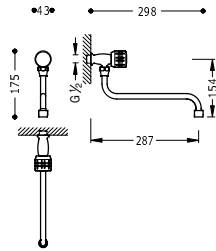

Grifo mural de 1 agua para office o lavadero
Con caño superior. Distancia a pared: 237 mm.

123506

38,50

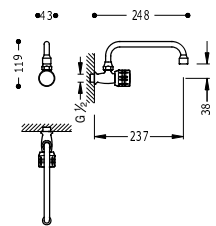

Dispensador de jabón empotrado a encimera
Para encimeras o fregaderos. Capacidad: 0,4 litros. Material: Metálico.

13474110

23,00

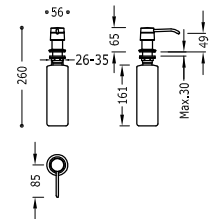

- 13474110NM 35,65 N
- 13474110BM 35,65 N
- 13474110AC 35,65 N
- 13474110OM 46,00 N

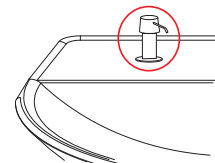

COLECTIVIDADES





Grifos temporizados	472
Grifos medicales	477
Grifos para peluquería	478
Grifos para exterior	479

GRIFOS TEMPORIZADOS PARA LAVABO

Grifo temporizado de 1 agua para lavabo

Cierre automático: 6 seg. Caudal: 0,7 l x ciclo.

20511201

113,00

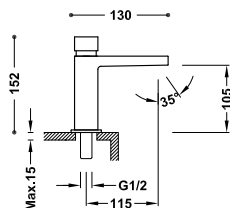

Grifo temporizado de 1 agua con sistema premezclador para lavabo

Cierre automático: 6 seg. Incluye una válvula mezcladora de 2 aguas con tubos flexibles (ref.: 19250730). Caudal: 0,7 l x ciclo.

20511202

153,00

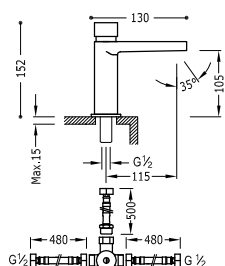

Grifo temporizado de 1 agua para lavabo

Cierre automático: 4,7 seg. Caudal: 0,4 l x ciclo.

01210303

90,00

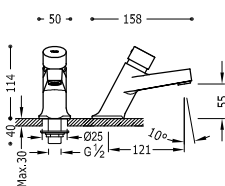

Grifo temporizado de 1 agua para lavabo

Cierre automático: 5,7 seg. Caudal: 0,5 l x ciclo.

01210302

87,00

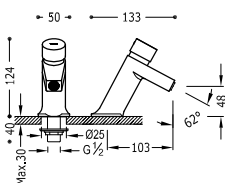

Grifo temporizado de 1 agua para lavabo

Conexión roscada macho de G1/2. Cierre automático: 4,5 seg. Caudal: 0,6 l x ciclo.

21210301

58,50

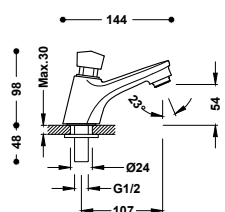

Grifo temporizado de 1 agua para lavabo

112103

98,00

Conexión roscada macho de G1/2. Cierre automático: 10,8 seg.
Caudal: 1,2 l x ciclo.

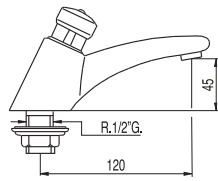

Grifo temporizado mural de 1 agua para lavabo

01210002

76,00

Conexión roscada macho de G1/2. Cierre automático: 6 seg.
Caudal: 0,5 l x ciclo.

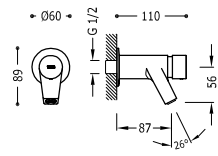

Grifo temporizado mural de 1 agua para lavabo

01210003

79,00

Conexión roscada macho de G1/2. Cierre automático: 6 seg.
Caudal: 0,5 l x ciclo.

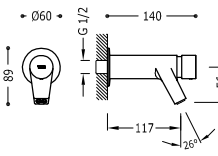

Grifo temporizado mural de 1 agua para lavabo

21210001

42,50

Conexión roscada macho de G1/2. Cierre automático: 4 seg.
Caudal: 0,8 l x ciclo.

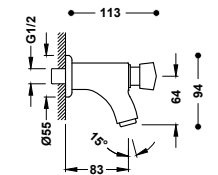

Grifo temporizado mural de 1 agua para lavabo

112100

80,50

Conexión roscada macho de G1/2. Cierre automático: 14 seg.
Caudal: 1,5 l x ciclo.

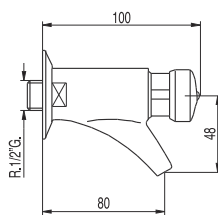

GRIFOS TEMPORIZADOS PARA URINARIO

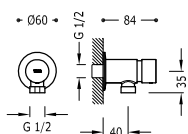

Grifo de descarga temporizado mural de 1 agua para urinario

01220002

70,00

Conexión roscada macho de G1/2. Cierre automático: 6 seg. Caudal: 0,7 l x ciclo.

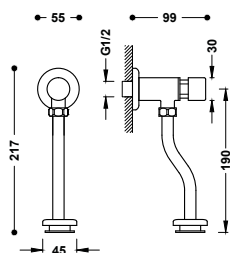

Grifo temporizado mural de 1 agua para urinario

21220001

38,00

Con un tubo adaptable al urinario. Cierre automático: 5 seg. Caudal: 1,5 l x ciclo.

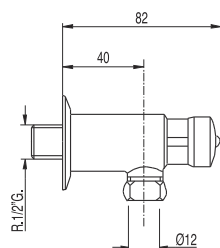

Grifo temporizado mural de 1 agua para urinario

112200

85,00

Conexión roscada macho de G1/2. Cierre automático: 4,8 seg. Caudal: 0,9 l x ciclo.

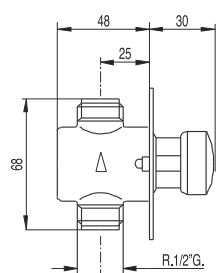

Grifo de descarga temporizado empotrado de 1 agua para urinario

01220801

76,00

Cuerpo empotrado incluido. Conexión roscada G1/2. Cierre automático: 4 seg. Caudal: 0,7 l x ciclo.

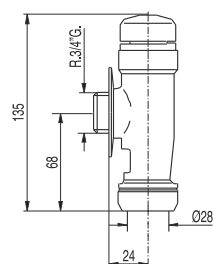

Grifo de descarga temporizado mural de 1 agua para urinario

112205

99,00

Conexión roscada macho G3/4. Salida de agua para tubo 26x28. Cierre automático: 3,5 seg. Caudal: 5,3 l x ciclo.



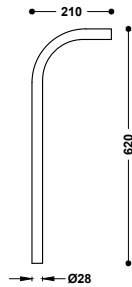

Tubo de descarga para grifo temporizado mural de urinario

13420503

55,50

GRIFOS TEMPORIZADOS PARA DUCHA

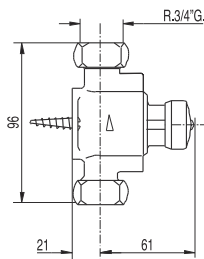

Grifo temporizado mural de 1 agua para ducha

Cierre automático: 15 seg. Caudal: 16 l/min.

112167

98,00

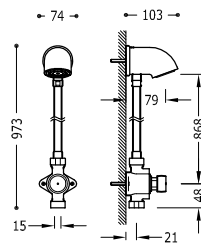

Conjunto de grifo temporizado mural de 1 agua para ducha

Regulador automático de caudal incorporado en el rociador. Caudal: 8-10 l/min.

112161

201,00

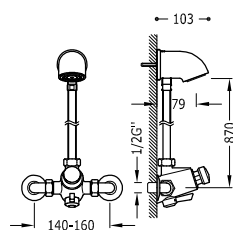

Conjunto de grifo temporizado mural con selector de temperatura para ducha

Regulador automático de caudal incorporado en el rociador. Caudal: 8-10 l/min. Entradas opuestas con racores extensibles y válvulas antirretorno.

112163

442,00

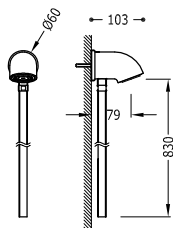

Rociador mural para ducha con tubo de conexión

Con tubo de conexión. Regulador automático de caudal incorporado en el rociador. Caudal: 8-10 l/min.

11216150

125,00

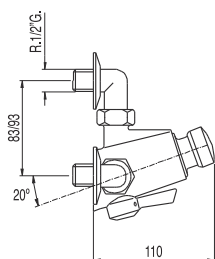

Grifo temporizado mural con selector de temperatura para ducha

Entradas opuestas con racores extensibles y válvulas antirretorno. Caudal: 16 l/min.

112162

395,00

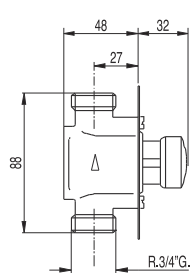

Grifo temporizado empotrado de 1 agua para ducha

Entrada y salida con rosca G3/4. Caudal: 20 l/min.

112178

89,50

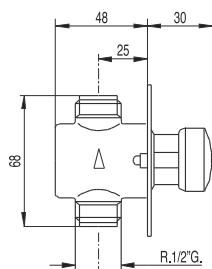

Grifo temporizado empotrado de 1 agua para ducha

Entrada y salida con rosca G1/2. Caudal: 16 l/min.

112177

76,50

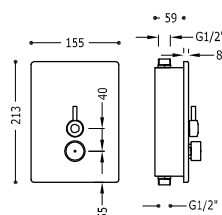

Grifo temporizado empotrado con selector de temperatura para ducha

2 entradas y 1 salida de agua con rosca G1/2.

01217901

455,00

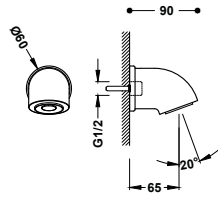

Rociador mural antivandálico para ducha

Regulador automático de caudal incorporado en el rociador.
Caudal: 6 l/min.

13416803

98,00

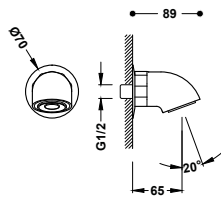

Rociador mural para ducha

Regulador automático de caudal incorporado en el rociador.
Caudal: 8-10 l/min. Conexión roscada macho G1/2.

13416703

76,00

GRIFOS MEDICALES

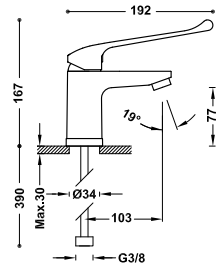

Grifo monomando medical

Con latiguillos de alimentación flexibles G3/8.

2161030111

92,30

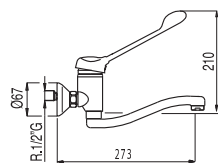

Grifo monomando medical mural

Con caño inferior. Distancia a pared: 273 mm.

17231811

190,00

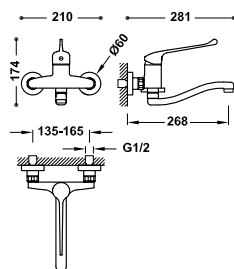

Grifo monomando medical mural

Con caño inferior. Distancia a pared: 268 mm.

2163200311

156,00



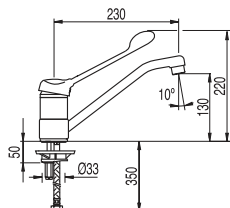

Grifo monomando medical
Con latiguillos de alimentación flexibles G3/8.

17233311

147,00

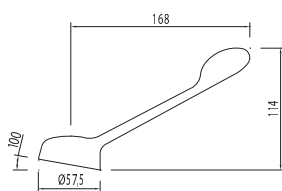

Palanca medical para grifo monomando
(para ref.: 1701030211, 17231811, 17233311)

9134011

43,00



GRIFOS PARA PELUQUERÍA

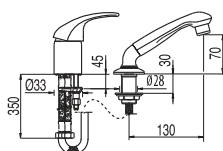

Grifo monomando para lavacabezas de peluquería
Con ducha de mano extraíble.

172450

124,00

GRIFOS PARA EXTERIOR

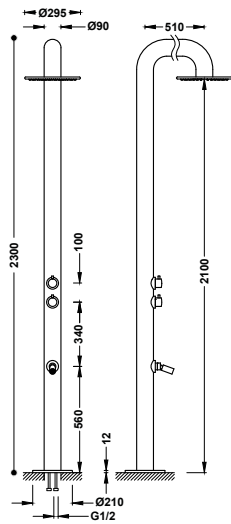

Columna de ducha para jardín o piscina de acero inoxidable 316

INCA 13499504

1.695,00

- Fabricada en acero inoxidable 316.
- Con tratamiento para exteriores que impide su deterioro.
- Con tomas de agua a suelo.
- Rociador de ducha fija Ø 295 mm. con sistema anticálcero.
- Grifo lavapiés con rótula orientable.
- Dispone de un mando para regular el caudal de ambas salidas y otro para controlar la temperatura.

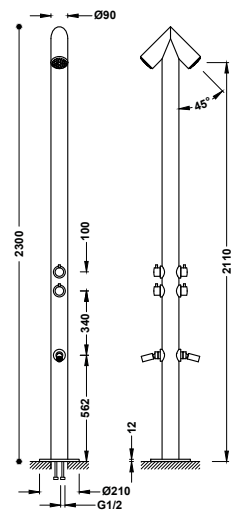
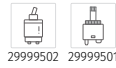

Columna con doble ducha para jardín o piscina de acero inoxidable 316

INCA 13499502

1.595,00

- Fabricada en acero inoxidable 316.
- Con tratamiento para exteriores que impide su deterioro.
- Con tomas de agua a suelo.
- Dos rociadores con sistema anticálcero.
- Dos grifos lavapiés con rótula orientable.
- Cada rociador dispone de un mando para regular el caudal de ambas salidas y otro para controlar la temperatura.

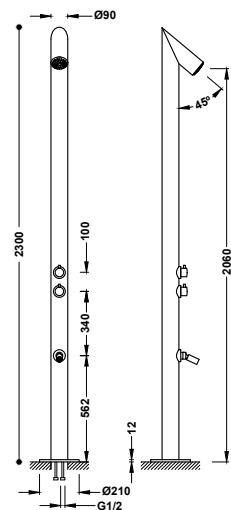
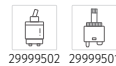

Columna de ducha para jardín o piscina de acero inoxidable 316

INCA 13499501

1.495,00

- Fabricada en acero inoxidable 316.
- Con tratamiento para exteriores que impide su deterioro.
- Con tomas de agua a suelo.
- Rociador con sistema anticálcero.
- Grifo lavapiés con rótula orientable.
- Dispone de un mando para regular el caudal de ambas salidas y otro para controlar la temperatura.



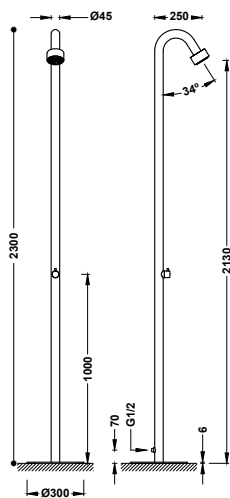

Columna de ducha de 1 agua para jardín o piscina de acero inoxidable 316

13499503

995,00

- Fabricada en acero inoxidable 316.
- Con tratamiento para exteriores que impide su deterioro.
- Toma de agua mediante una conexión a manguera G1/2.
- Ducha superior con sistema anticalcáreo.

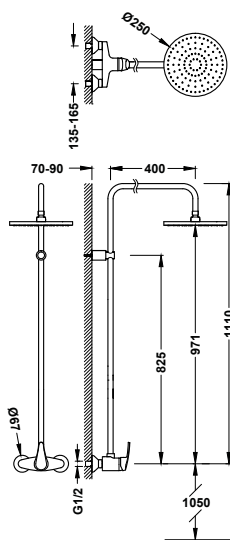

Conjunto de grifo monomando mural de 1 vía para jardín o piscina

07099501

298,00

- Rociador de ducha orientable: Ø 250 mm.

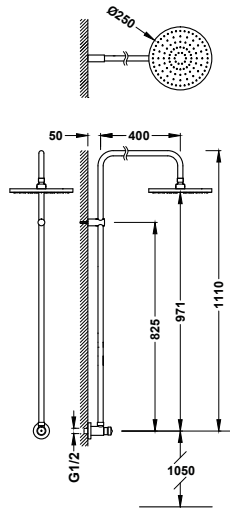

Conjunto de grifo temporizado mural de 1 agua para jardín o piscina

01299601

260,00

- Rociador de ducha orientable: Ø 250 mm.

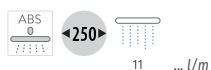

Grifo mural de 1 agua para jardín
con aireador.

03450101

24,50

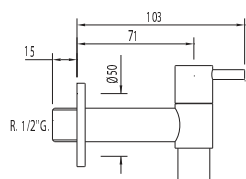

Grifo mural de 1 agua con conexión rápida a manguera

03450102

25,00

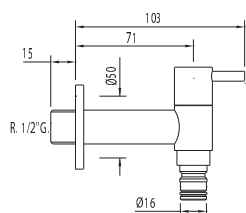

COMPLEMENTOS DE GRIFERÍA





Válvulas y desagües 484

Sifones 494

Llaves de paso 497

Conexiones acodadas y alargaderas 499

Caños 501

Florones 504

Excéntricas 505

Válvulas de vaciado 506

WC SYSTEMS 508

Mecanismos de llenado 510

Mecanismos de descarga 511

TRES CLEANER 514

Limpiador de grifería 516



VÁLVULAS SIMPLE-RAPID PARA LAVABO

Válvula de desagüe Click-Clack Simple-Rapid para lavabo
 Apto para lavamanos con y sin rebosadero. Función Click-Clack. Tapón Ø 63 mm. Simple-Rapid fácil instalación.

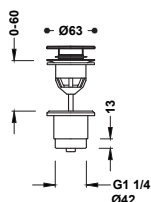

- 24284001 **46,50**
- 24284001NM **72,10**
- 24284001BM **72,10**
- 24284001AC **72,10**
- 24284001KM **72,10**
- 24284001KMB **72,10**
- 24284001OR **93,00**
- 24284001OM **93,00**
- 24284001OP **93,00**
- 24284001OPM **93,00**
- 24284001LV **65,10**
- 24284001LM **65,10**
- 24284001AM **72,10**
- 24284001RO **72,10**
- 24284001NE **72,10**
- 24284001BL **72,10**

Válvula de desagüe Click-Clack Simple-Rapid para lavabo
 Apto para lavamanos con y sin rebosadero. Función Click-Clack. Tapón Ø 40 mm. Simple-Rapid fácil instalación.

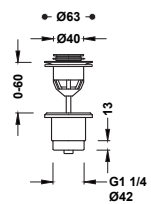

- 24284002 **43,50**
- 24284002NM **67,45**
- 24284002BM **67,45**
- 24284002AC **67,45**
- 24284002KM **67,45**
- 24284002KMB **67,45**
- 24284002OR **87,00**
- 24284002OM **87,00**
- 24284002OP **87,00**
- 24284002OPM **87,00**
- 24284002LV **60,90**
- 24284002LM **60,90**
- 24284002NE **67,45**
- 24284002BL **67,45**

Válvula de desagüe Click-Clack Simple-Rapid para lavabo con opción siempre abierta
 Incluye un adaptador que da la opción para que el tapón siempre quede abierto. Apto para lavamanos con y sin rebosadero.

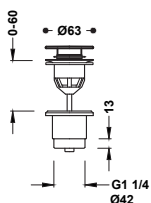

24284010 **49,50** N

También disponible con acabados (mirar web):

- -
 -
 -
 -
 -
 -
 -
 -
 -
 -
 -
 -
 -
 -
- NM BM AC KM KMB OR OM OP OPM LV LM AM RO NE BL

Válvula de desagüe Click-Clack Simple-Rapid para lavabo con opción siempre abierta
 Incluye un adaptador que da la opción para que el tapón siempre quede abierto. Apto para lavamanos con y sin rebosadero.

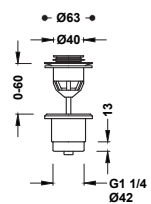

24284020 **46,50** N

También disponible con acabados (mirar web):

- -
 -
 -
 -
 -
 -
 -
 -
 -
 -
 -
 -
- NM BM AC KM KMB OR OM OP OPM LV LM NE BL

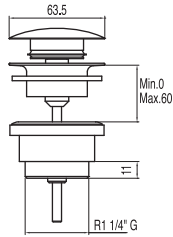

Válvula de desagüe Click-Clack Simple-Rapid para lavabo

Apto para lavamanos con y sin rebosadero. Función Click-Clack.
Tapón: Ø 63,5 mm. Simple-Rapid fácil instalación.

161840

42,00

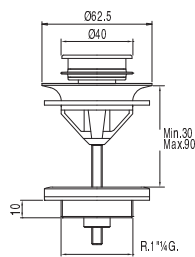

Válvula de desagüe Click-Clack Simple-Rapid para lavabo

Apto para lavamanos con y sin rebosadero. Función Click-Clack.
Tapón: Ø 40 mm. Simple-Rapid fácil instalación.

162840

33,00

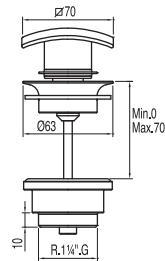

Válvula de desagüe Click-Clack Simple-Rapid para lavabo

Apto para lavamanos con y sin rebosadero. Función Click-Clack.
Tapón: Ø 70x70 mm. Simple-Rapid fácil instalación.

107940

62,00

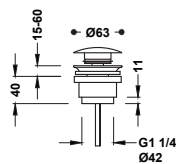

Válvula de desagüe Click-Clack Simple-Rapid para lavabo

Apto para lavamanos con y sin rebosadero. Función Click-Clack.
Tapón: Ø 63 mm. Simple-Rapid fácil instalación.

13454010

24,20

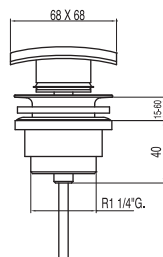

Válvula de desagüe Click-Clack Simple-Rapid para lavabo

Apto para lavamanos con y sin rebosadero. Función Click-Clack.
Tapón: 68x68 mm. Simple-Rapid fácil instalación.

13434010

29,20



VÁLVULAS PARA LAVABO SIN REBOSADERO

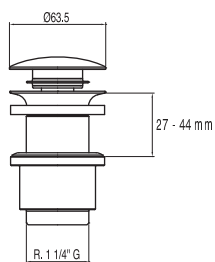

Válvula de desagüe Click-Clack para lavabo sin rebosadero
 Para encimeras de madera de 27-44 mm. Sin rebosadero. Función Click-Clack. Tapón: Ø 63.5 mm.

13494010

58,00

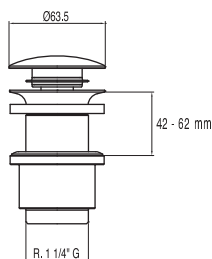

Válvula de desagüe Click-Clack para lavabo sin rebosadero
 Para encimeras de madera de 42-62 mm. Sin rebosadero. Función Click-Clack. Tapón: Ø 63.5 mm.

13494110

60,00

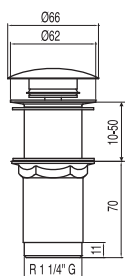

Válvula de desagüe Click-Clack para lavabo sin rebosadero
 Sin rebosadero. Función Click-Clack. Tapón: Ø 66 mm.

13454060

24,00

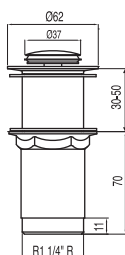

Válvula de desagüe Click-Clack para lavabo sin rebosadero
 Sin rebosadero. Función Click-Clack. Tapón: Ø 37 mm.

13454050

21,00

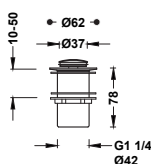

Válvula de desagüe Click-Clack para lavabo sin rebosadero
 Sin rebosadero. Función Click-Clack. Tapón: Ø 37 mm.

13454070

17,00

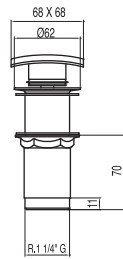

Válvula de desagüe Click-Clack para lavabo sin rebosadero
Sin rebosadero. Función Click-Clack. Tapón: 68x68 mm.

13434120

29,00

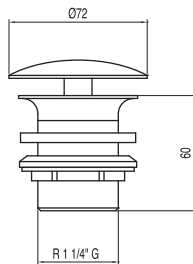

Válvula de desagüe siempre abierto para lavabo sin rebosadero
Sin rebosadero. Tapón: Ø 72 mm.

13424010

22,00

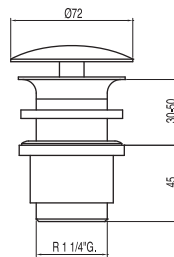

Válvula de desagüe siempre abierto para lavabo sin rebosadero
Sin rebosadero. Tapón: Ø 72 mm.

13424020

28,00

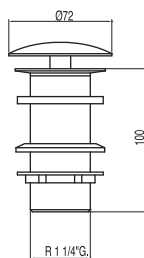

Válvula de desagüe siempre abierto para lavabo sin rebosadero
Sin rebosadero. Tapón: Ø 72 mm.

13424030

23,50

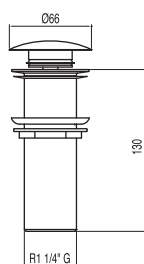

Válvula de desagüe Click-Clack para lavabo sin rebosadero
Sin rebosadero. Función Click-Clack. Tapón: Ø 66 mm.

13454030

36,70



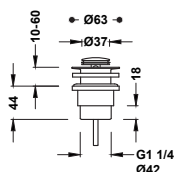

Válvula de desagüe Click-Clack para lavabo sin rebosadero
Sin rebosadero. Función Click-Clack. Tapón: Ø 37 mm.

134215026

12,30

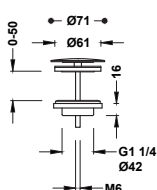

Válvula de desagüe siempre abierto para lavabo sin rebosadero
Sin rebosadero. Tapón: Ø 71 mm.

134215028

18,50

VÁLVULAS PARA LAVABO CON REBOSADERO

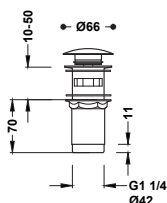

Válvula de desagüe Click-Clack para lavabo con rebosadero
Con rebosadero. Función Click-Clack. Tapón: Ø 66 mm.

13454160

24,00

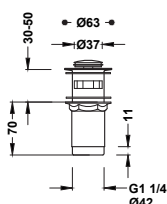

Válvula de desagüe Click-Clack para lavabo con rebosadero
Con rebosadero. Función Click-Clack. Tapón: Ø 37 mm.

13454110

21,00

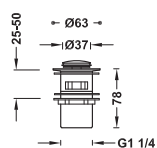

Válvula de desagüe Click-Clack para lavabo con rebosadero
Con rebosadero. Función Click-Clack. Tapón: Ø 37 mm.

13454190

17,00

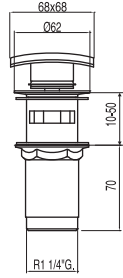

Válvula de desagüe Click-Clack para lavabo con rebosadero
Con rebosadero. Función Click-Clack. Tapón: 68x68 mm.

13434020

29,00

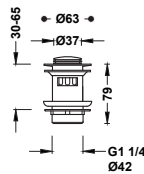

Válvula de desagüe Click-Clack para lavabo con rebosadero
Con rebosadero. Función Click-Clack. Tapón: Ø 37 mm.

134215025

18,50

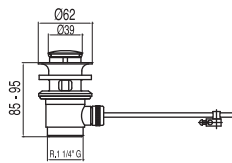

Válvula de desagüe automático para lavabo con rebosadero
Con rebosadero. Tapón: Ø 39 mm.

13474310

16,80



Válvula de desagüe con tapón y cadenilla para lavabo con rebosadero
Cadenilla de 250 mm.

13474320

16,60

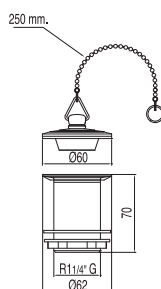

Válvula de desagüe con tapón y cadenilla para lavabo sin rebosadero
Cadenilla de 250 mm.

13474330

16,60



COMPLEMENTOS DE GRIFERÍA

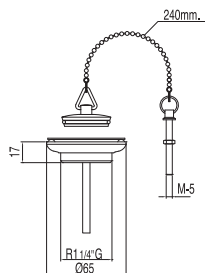

Cazoleta plana de desagüe con kit de enganche de cadenilla y tapón para lavabo, bidé y fregadero
Cadenilla de 240 mm.

13463910

11,00

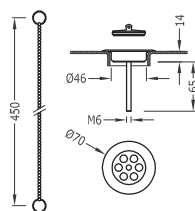

Cazoleta plana de desagüe con cadenilla y tapón para lavabo, bidé y fregadero
Cadenilla: 450 mm. Cazoleta: Ø 70 mm. Tapón metálico.

03474601

30,00

03474601AC

46,50

03474601OR

60,00

03474601OM

60,00

9134746051

42,00

03474601LM

42,00

COMPLEMENTOS PARA VÁLVULAS

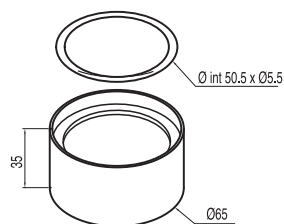

Separador para válvula de desagüe

Para lavamanos de sobre-encimera. Diámetro: Ø 65 mm.
Altura: 35 mm.

916110348

35,00

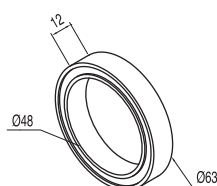
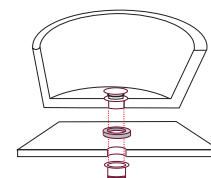

Separador para válvula de desagüe

Para lavamanos de sobre-encimera. Diámetro: Ø 63 mm.
Altura: 12 mm.

13463310

13,60

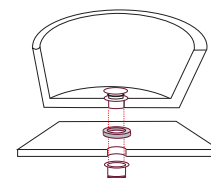

Tapón para válvula de desagüe Click-Clack
 Función Click-Clack. Tapón: Ø 63.5 mm. Para ref.: 161840.

916184060 **27,00**

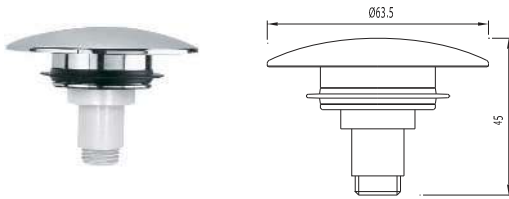

Adaptador para lavamanos de cristal o acero inoxidable que no poseen rebosadero
 Con rebosadero. Tubo flexible: 320 mm.

13463450 **22,20**

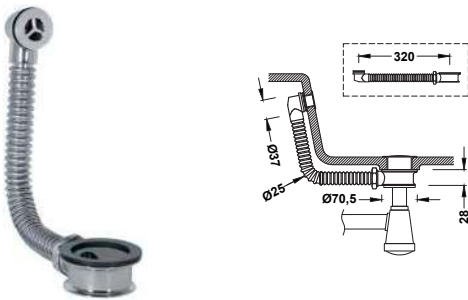

DESAGÜES PARA DUCHA O BAÑERA

Válvula de desagüe Click-Clack con rebosadero para bañera
 Tapón: Ø 72 mm. Tubo flexible: máx. 680 mm.

13453420 **30,00**

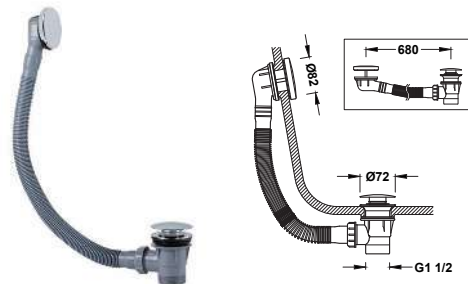

- 03453420NM **46,50**
- 03453420BM **46,50**
- 03453420AC **46,50**
- 03453420KM **46,50** N
- 03453420KMB **46,50** N
- 03453420OR **60,00**
- 03453420OM **60,00**
- 03453420OP **60,00**
- 03453420OPM **60,00**
- 03453420LV **42,00**
- 03453420LM **42,00**

Válvula de desagüe redondo Click-Clack y de llenado con rebosadero para bañera
 Tapón: Ø 70 mm. Tubo flexible: máx. 980 mm.

13453430 **67,00**

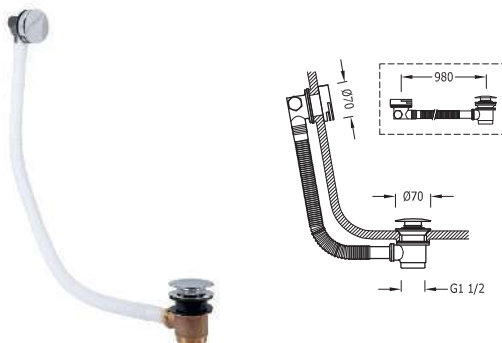

- 03453430NM **104,00**
- 03453430BM **104,00**
- 03453430AC **104,00**
- 03453430KM **104,00** N
- 03453430KMB **104,00** N
- 03453430OR **134,00**
- 03453430OM **134,00**
- 03453430OP **134,00**
- 03453430OPM **134,00**
- 03453430LV **93,80**
- 03453430LM **93,80**

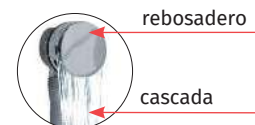

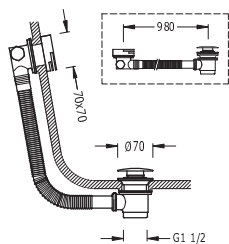

Válvula de desagüe cuadrado Click-Clack y de llenado con rebosadero para bañera

Tapón: Ø 70 mm. Tubo flexible: máx. 980 mm.

- 13453440 **92,00**
- 03453440NM **143,00**
- 03453440AC **143,00**
- 03453440OR **184,00**
- 03453440OM **184,00**

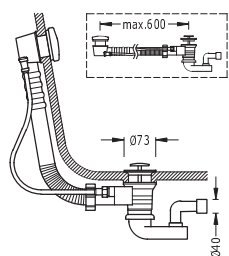
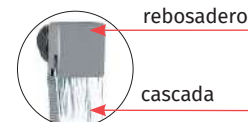

Válvula de desagüe automático para bañera con rebosadero

Con rebosadero. Se puede abrir y cerrar la válvula de desagüe girando el volante situado sobre el desaguadero. Tapón: Ø 43 mm. Tubo flexible: máx. 600 mm.

- 134846 **105,00**

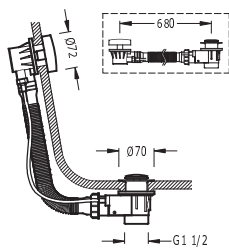

Válvula de desagüe automático para bañera con rebosadero

Con rebosadero. Se puede abrir y cerrar la válvula de desagüe girando el volante situado sobre el desaguadero. Tapón: Ø 43 mm. Tubo flexible: máx. 680 mm.

- 13453410 **34,00**

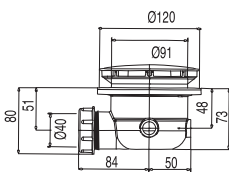

Desagüe sifónico inspeccionable para plato de ducha

Con sifón incorporado. Tapón: Ø 120 mm. Volumen de desagüe: 31 l/min.

- 104840 **46,00**

Desagüe sifónico inspeccionable para plato de ducha

Con sifón incorporado. Tapón: Ø 118 mm. Volumen de desagüe: 62 l/min.

104841

40,00

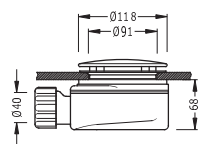

Válvula de desagüe Click-Clack para bañera

Función Click-Clack. Tapón: Ø 70 mm.

13474010

19,50

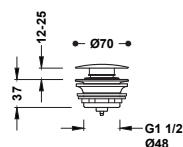

Válvula de desagüe Click-Clack con tapón oculto para bañera

Función Click-Clack. Tapón: Ø 36 mm.

134215027

12,40

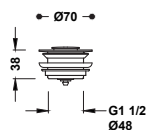

Desagüe para lavadero o similar

Tapón: Ø 72 mm.

13474020

8,80

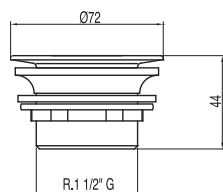

Cazoleta plana de desagüe con kit de enganche de cadena y tapón para bañera

Cadenilla: 450 mm. Cazoleta: Ø 70 mm. Tapón metálico.

03474501

38,00

03474501AC

58,90

03474501OR

76,00

03474501OM

76,00

9134745051

53,20

03474501LM

53,20

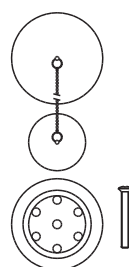

SIFONES

Sifón telescópico cuadrado inspeccionable con faldón para lavabo

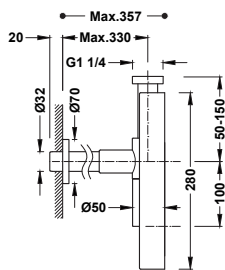

	10710342	195,00
	10710342NM	302,00
	10710342BM	302,00
	10710342AC	302,00
	10710342KM	302,00
	10710342KMB	302,00
	10710342OR	390,00
	10710342OM	390,00
	10710342OP	390,00
	10710342OPM	390,00

Sifón telescópico redondo inspeccionable con faldón para lavabo

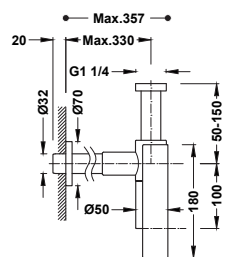

	16110342	165,00
	16110342NM	256,00
	16110342BM	256,00
	16110342AC	256,00
	16110342KM	256,00
	16110342KMB	256,00
	16110342OR	330,00
	16110342OM	330,00
	16110342OP	330,00
	16110342OPM	330,00

Sifón telescópico tipo botella inspeccionable para lavabo

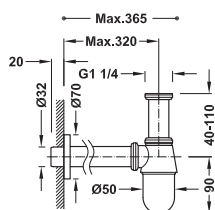

	13463430	30,00
	03463430NM	72,00
	03463430BM	72,00
	03463430AC	72,00
	03463430KM	72,00 ^N
	03463430KMB	72,00 ^N
	03463430OR	192,00
	03463430OM	192,00
	03463430OP	192,00
	03463430OPM	192,00
	03463430LV	72,00
	03463430LM	72,00

Sifón telescópico con registro para lavabo

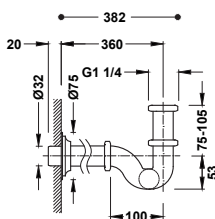

	13463820	32,00
	03463820NM	76,00 ^N
	03463820BM	76,00 ^N
	03463820AC	76,00
	03463820KM	76,00 ^N
	03463820KMB	76,00 ^N
	03463820OR	204,00
	03463820OM	204,00
	03463820OP	204,00
	03463820OPM	204,00
	03463820LV	76,00
	03463820LM	76,00

Sifón telescópico acodado para lavabo

16110362

175,00

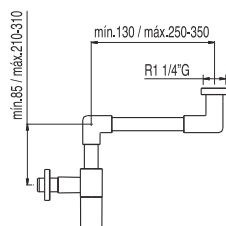

Sifón telescópico para lavabo

16110372

82,00

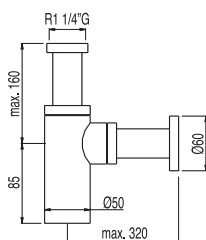

Sifón telescópico para lavabo

13463410

41,00

13463410NM

63,55

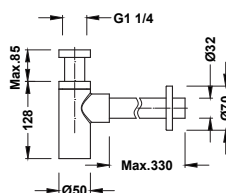

Sifón telescópico para lavabo

13463420

61,00

13463420NM

94,55

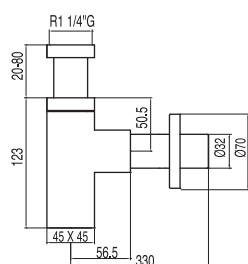

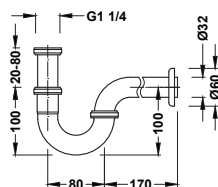

Sifón telescópico giratorio para lavabo

Tubo de salida giratorio. Ideal para cualquier instalación.

13463810

21,00

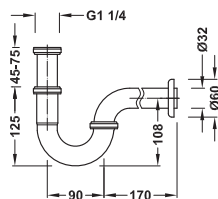
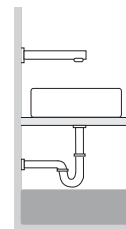

Sifón telescópico giratorio para lavabo

Tubo de salida giratorio. Ideal para cualquier instalación.

134215024

12,30

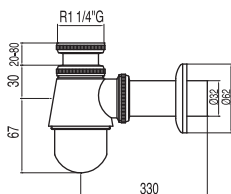
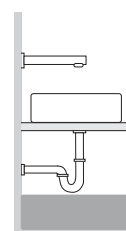

Sifón telescópico tipo botella inspeccionable para bidé

13463440

22,10

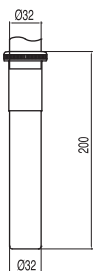
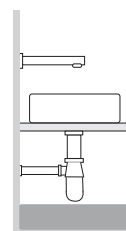

Alargadera para sifón telescópico tipo botella

Longitud: 200 mm.

913463320

11,00

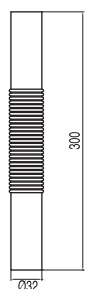
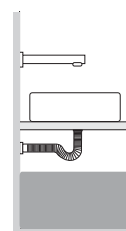

Tubo flexible corrugado para sifón telescópico tipo botella

Longitud: 300 mm.

913463330

11,00

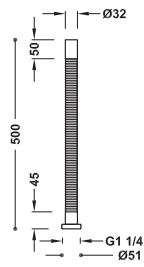

Tubo flexible coarrugado para desagüe

913463250

17,00

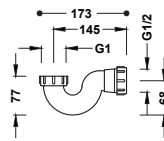

Sifón de PVC para bañera

13463460

4,40

LLAVES DE PASO

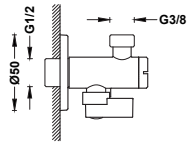

Llave de escuadra con filtro
R.1/2" - R.3/8"

9134525

15,60

9134525NM

24,20

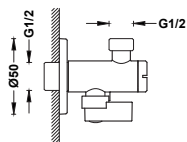
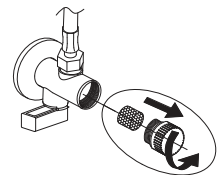

Llave de escuadra con filtro
R.1/2" - R.1/2"

29952505

15,60

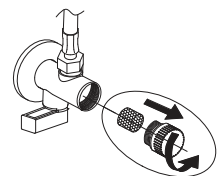

CONEXIONES ACODADAS Y ALARGADERAS

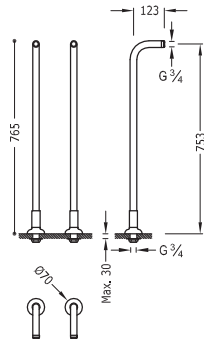

Tomas de agua acodadas de instalación a suelo para grifo de bañera

2 columnas verticales de alimentación de agua a suelo.

- 24219403 **350,00**
- 24219403AC **543,00**
- 24219403LV **490,00**
- 24219403LM **490,00**

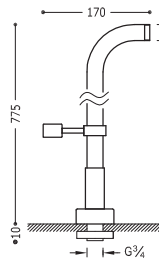

Tomas de agua acodadas de instalación a suelo para grifo de bañera

2 unidades con soporte fijo para ducha de mano.

- 161194 **300,00**

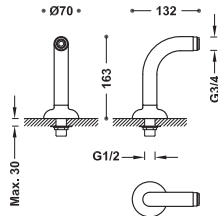

Tomas de agua acodadas de instalación a borde bañera para grifo de bañera

2 unidades con silenciador.

- 24287101 **150,00**
- 24287101NM **233,00**
- 24287101AC **233,00**
- 24287101OR **300,00**
- 24287101LV **210,00**
- 24287101LM **210,00**

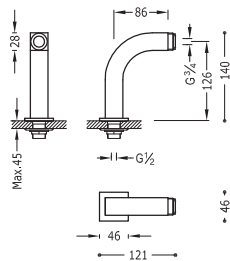

Tomas de agua acodadas de instalación a borde bañera para grifo de bañera

2 unidades con silenciador.

- 29987002 **120,00**



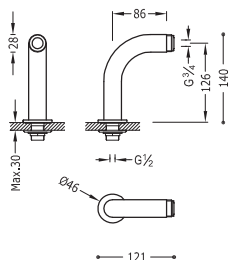

Tomas de agua acodadas de instalación a borde bañera para grifo de bañera
2 unidades con silenciador.

29987001

110,00

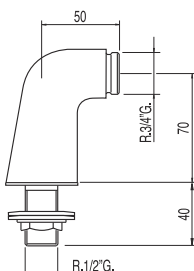

Tomas de agua acodadas de instalación a borde bañera para grifo de bañera
2 unidades con silenciador.

134870

86,00

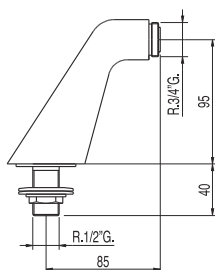

Tomas de agua acodadas de instalación a borde bañera para grifo de bañera
2 unidades con silenciador.

134871

99,00

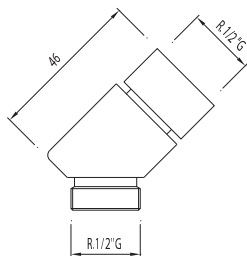

Conexión acodada universal para ducha de mano

Apto para bañeras de repisa. Para ref.: 14150, 61150, 62150, 63145, 61161, 87150, 87161, 89150, 89161.

913414580

42,00

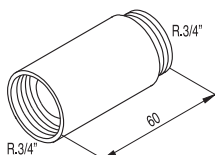

Alargadera para grifería de pared

2 unidades macho-hembra de 6 cm de longitud con silenciador.

9134872

34,50

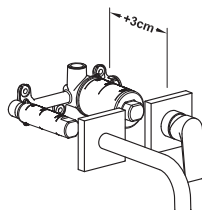

Set de prolongación para los grifos monomando empotrado para lavabo

21830010

44,80

Apto para todas las series de Tres, con cuerpo empotrado indivisible con amortiguadores acústicos, excepto la Tres-Classic. Profundidad: 30 mm.



Set de prolongación para los grifos monomando empotrado de 2 vías Rapid-box

29928010

50,00

Profundidad: 30 mm.



CAÑOS

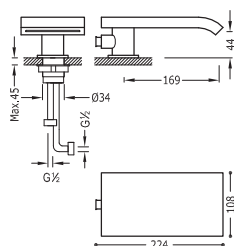

Caño fijo para borde bañera con salida en cascada

16216150

300,00

Caño cerrado con salida del agua en cascada. Inversor integrado en el caño.

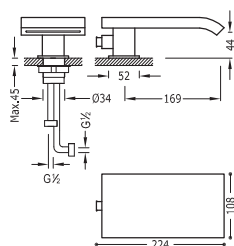

Caño fijo para borde bañera con salida en cascada

18718250

350,00

Caño cerrado con salida del agua en cascada. Inversor integrado en el caño.

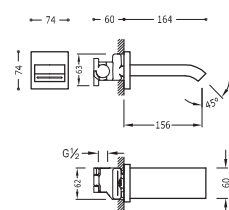

Caño fijo de pared con salida en cascada

107181

195,00

Caño cerrado con salida del agua en cascada. Con toma de agua a pared regulable en profundidad. Cuerpo empotrado incluido.



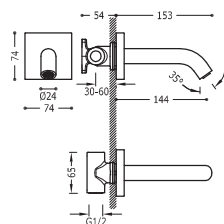

Caño fijo de pared

Con toma de agua a pared regulable en profundidad. Cuerpo empotrado incluido.

	21018107	99,00
	21018107NM	153,00
	21018107BM	153,00
	21018107AC	153,00
	21018107KM	153,00
	21018107KMB	153,00
	21018107OR	198,00
	21018107OM	198,00
	21018107OP	198,00
	21018107OPM	198,00

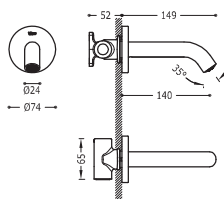

Caño fijo de pared





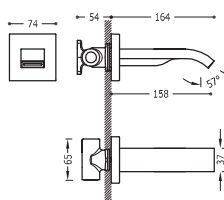

Con toma de agua a pared regulable en profundidad. Cuerpo empotrado incluido.

	26218004	99,00
	26218004NM	153,00
	26218004BM	153,00
	26218004AC	153,00
	26218004KM	153,00
	26218004KMB	153,00
	26218004OR	198,00
	26218004OM	198,00
	26218004OP	198,00
	26218004OPM	198,00



Caño fijo de pared con salida en cascada

Caño cerrado con salida del agua en cascada. Con toma de agua a pared regulable en profundidad. Cuerpo empotrado incluido.

	20718107	155,00
	20718107NM	240,00
	20718107BM	240,00
	20718107AC	240,00
	20718107OR	310,00
	20718107OM	310,00

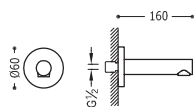

Caño fijo de pared

Con toma de agua roscada G1/2. Longitud: 160 mm. No es un recambio. No es compatible con cuerpos empotrados indivisibles.

	16117002	99,00
---	----------	--------------

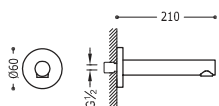

Caño fijo de pared

Con toma de agua roscada G1/2. Longitud: 210 mm. No es un recambio. No es compatible con cuerpos empotrados indivisibles.

	06117202	105,00
---	----------	---------------

Caño fijo de pared

16117102

111,00

Con toma de agua roscada G1/2. Longitud: 250 mm. No es un recambio. No es compatible con cuerpos empotrados indivisibles.



Caño giratorio de pared

134301

85,00

Tipo fundido. Longitud: 255 mm.



Caño giratorio de pared

134302

45,00

Tipo tubo. Longitud: 237 mm.



Caño giratorio de pared

134303

49,00

Tipo tubo. Longitud: 287 mm.



FLORONES

Florón cuadrado

Material: Latón.

913474410

5,50

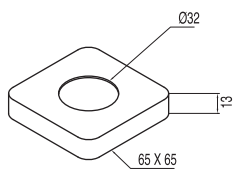

Florón redondo

Material: Latón.

913474430

8,50

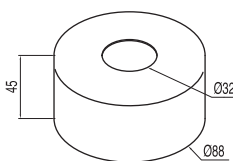

Florón redondo

Material: Latón.

913474420

5,70

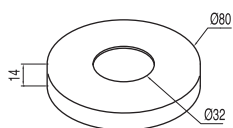

Florón para excéntricas especiales

Material: Latón. Ø 70 mm.

9134781

6,10

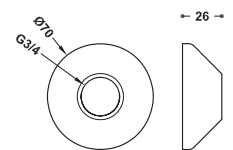

Florón para excéntricas especiales

Material: Latón. Ø 80 mm.

9134784

7,50

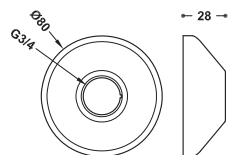

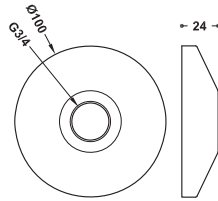

Florón para excéntricas especiales
Material: Latón. Ø 100 mm.

9134788

11,00

EXCÉNTRICAS



Excéntrica con silenciador para desplazar la toma de la grifería
Conexión roscada macho: 1/2". Desplazamiento: 7,5 mm. 13,5 - 16,5 mm.

9134779

9,50

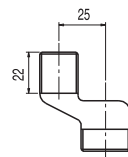

Excéntrica con silenciador para desplazar la toma de la grifería
Conexión roscada macho: 1/2". Desplazamiento: 25 mm. 10 - 20 mm.

9134780

11,00

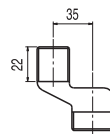

Excéntrica para desplazar la toma de la grifería
Conexión roscada macho: 1/2". Desplazamiento: 35 mm. 8 - 22 mm.
Compatible con el florón ref.: 9134788

9134787

11,00

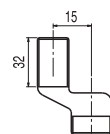

Excéntrica con silenciador para desplazar la toma de la grifería
Conexión roscada macho: 1/2". Desplazamiento: 15 mm. 12 - 18 mm.

9134786

11,00



VÁLVULAS DE VACIADO

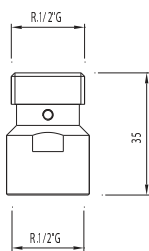

Válvula de vaciado

Funciona con las duchas: 134126, 9134729, 913472906, 9134725, 134821, 134617, 134616, 134924, 9134824, 913482510, 134611. Funciona con los rociadores: 13413825, 13413826, 13413830, 19312310, 13413725, 13413726, 13413730.

913478906

16,70

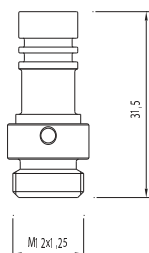

Válvula de vaciado

Para ref.: 07395, 07926, 07131.

913478907

14,50

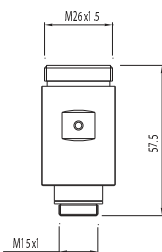

Válvula de vaciado

Para ref.: 81385, 81191. Anterior al año 2012.

913478908

16,70

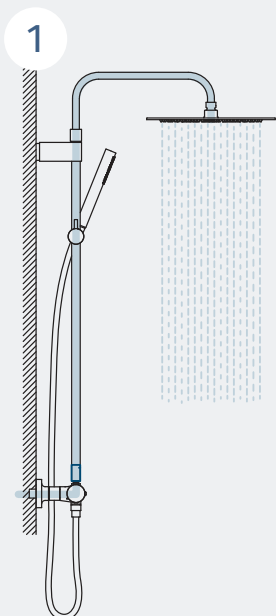

LIMITADOR

Limita el caudal del agua liberando de presión el rociador.

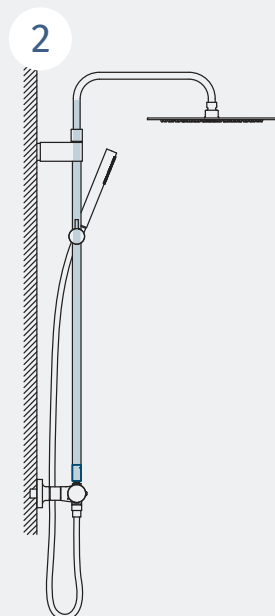

ANTILEGIONELA

Evita la procreación de bacterias como la legionela.

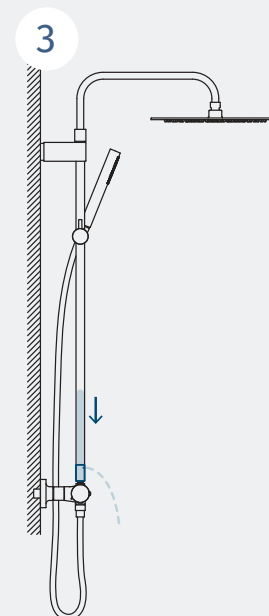

ANTIGOTEO

Una vez finalizada la utilización de la ducha, éste evita el goteo del rociador.

VÁLVULA TERMOSTÁTICA

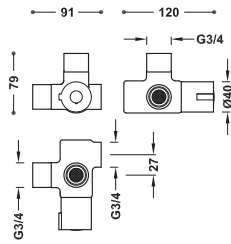

Válvula termostática para el calentador

20725001

155,00

- Filtros en las entradas de agua.
- Con válvulas antirretorno en las entradas de agua.
- Ideal para espacios públicos donde queremos temperatura constante.

- Cuerpo de latón.
- Reduce el consumo de energía y agua en circuitos de recirculación.
- Aumenta el volumen de agua caliente ya que a la salida del calentador añadimos agua fría.
- Seguridad: evita quemaduras causadas por el agua caliente.

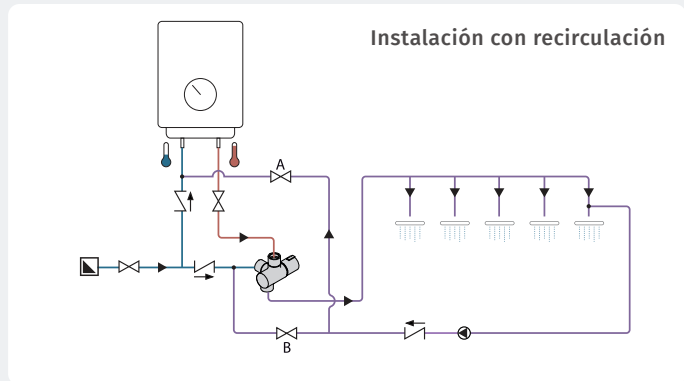
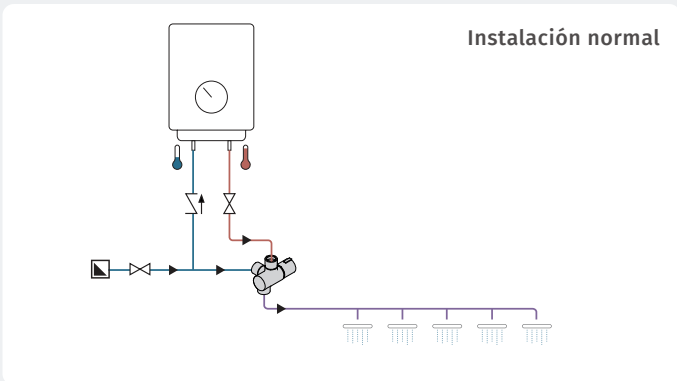

WC SYSTEMS

Tres ofrece mecanismos para la cisterna de wáter como una alternativa económica y de calidad en estos elementos presentes en un cuarto de baño. Distintos mecanismos de llenado y de vaciado con un funcionamiento e instalación similar pero con características particulares para resolver las distintas necesidades de cada tipo de cisterna.





MECANISMOS DE LLENADO

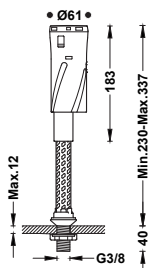

Mecanismo de llenado para cisterna de inodoro

25477001

11,20

- Monobloc de llenado inferior.
- Entrada de agua G3/8 con racord de latón.
- Con ajuste de nivel de agua fácil y rápido.
- Con filtro de fácil acceso.
- Extra silencioso. Solo 16 db.
- Llenado rápido: 5,2 l. (5 bars)
- Regulación superior.

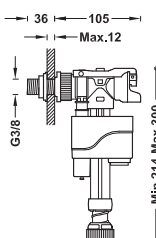

Mecanismo de llenado para cisterna de inodoro

25477007

12,50

- De llenado inferior o lateral.
- Entrada de agua lateral o inferior intercambiando el racord de latón.
- Entrada de agua G3/8 racord de latón.
- Filtro en la entrada de agua.
- Con ajuste de nivel de agua fácil y rápido.
- Regulación superior.

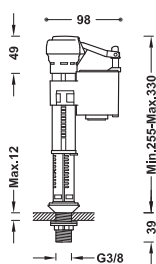

Mecanismo de llenado para cisterna de inodoro

25477002

9,40

- De llenado inferior.
- Entrada de agua G3/8 con racord de latón.
- Filtro en la entrada de agua.
- Con ajuste de nivel de agua.
- Regulación superior.

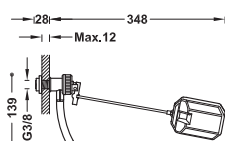

Mecanismo de llenado para cisterna de inodoro

25477004

8,50

- De llenado lateral.
- Sujeción de la boya con varilla de latón.
- Entrada de agua G3/8 racord de latón.
- Filtro en la entrada de agua.

Mecanismo de llenado para cisterna de inodoro

25477003

9,90

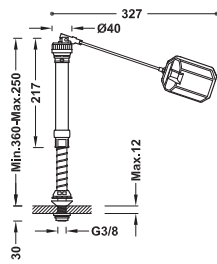

- De llenado inferior.
- Sujeción de la boya con varilla de latón.
- Entrada de agua G3/8 racord de latón.
- Filtro en la entrada de agua.
- Con ajuste de nivel de agua.

MECANISMOS DE DESCARGA

Mecanismo de descarga para cisterna de inodoro

25477012

11,50

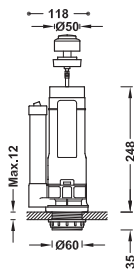

- Descarga única.
- Accionamiento superior.
- Mecanismo universal con pulsador.
- Botón de descarga única.
- Ajuste de la altura del rebosadero.
- Rango de ajuste para la descarga.
- Con junta de silicona.

Mecanismo de descarga para cisterna de inodoro

25477009

14,50

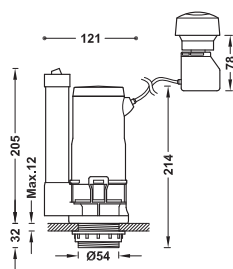

- Doble descarga.
- Accionamiento superior o lateral.
- Mecanismo universal con doble pulsador.
- Botón de descarga total y botón de descarga parcial.
- Ajuste de la altura del rebosadero.
- Con junta de silicona.

Mecanismo de descarga para cisterna de inodoro

25477005

12,00

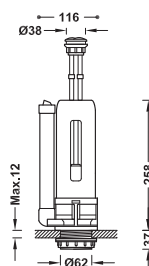

- Doble descarga.
- Accionamiento superior.
- Mecanismo universal con doble pulsador.
- Botón de descarga total y botón de descarga parcial.
- Velocidad de descarga rápida.
- Con junta de silicona.



		<p>Junta de conexión Material: Foam. Dimensiones: 106x65x16 mm.</p>	<p>25477006</p>	<p>1,80</p>
		<p>Junta de silicona Dimensiones: 65x42x2 mm.</p>	<p>25477010</p>	<p>1,90</p>
		<p>Tornillos de fijación de cisterna a inodoro</p>	<p>25477008</p>	<p>4,00</p>
		<p>Varilla roscada 2 unidades</p>	<p>25477011</p>	<p>1,85</p>
		<p>Tapón para la cisterna</p>	<p>25477013</p>	<p>1,55</p>

Conjunto completo de mecanismo de llenado para cisterna de inodoro

25477091

33,00

- 25477001 - Mecanismos de llenado
- 25477009 - Mecanismos de descarga
- 25477006 - Junta de conexión
- 25477008 - Tornillos de fijación de cisterna
- 25477013 - Tapón para la cisterna



Conjunto completo de mecanismo de llenado para cisterna de inodoro

25477092

34,35

- 25477007 - Mecanismos de llenado
- 25477009 - Mecanismos de descarga
- 25477006 - Junta de conexión
- 25477008 - Tornillos de fijación de cisterna
- 25477013 - Tapón para la cisterna



TRES CLEANER

Tres Cleaner es un espray limpiador para grifería de baño y cocina testado para los productos Tres. Doble función para eliminar la suciedad y mantener el acabado de la grifería. El limpiador de grifería funciona pulverizando la zona a lavar, dejándolo actuar brevemente, aclarando con agua tibia y secándolo con un paño suave.





Tres Cleaner

Lo más recomendado para limpiar las superficies metálicas y brillantes de los grifos

- Abrillanta las superficies
- Elimina las huellas
- Repele la suciedad
- Elimina la cal
- Efecto antiestático



Con la boquilla abierta se dispersa el líquido con un pulverizador fino que llega a áreas más grandes, como mamparas y espejos.



Con la boquilla cerrada, la espuma limpiadora activa se adhiere y actúa significativamente más sobre la suciedad y permite una limpieza más profunda.

LIMPIADOR DE GRIFERÍA



Tres Cleaner. Limpiador de grifería para baño y cocina

134100106

12,35

- Abrillanta las superficies.
- Elimina las huellas.
- Repele la suciedad.
- Elimina la cal.
- Efecto anti-estático.



Caja de 12 unidades. Tres Cleaner. Limpiador de grifería para baño y cocina

134100106CB12

133,00

- Abrillanta las superficies.
- Elimina las huellas.
- Repele la suciedad.
- Elimina la cal.
- Efecto anti-estático.



Conjunto completo para el mantenimiento y limpieza de rociadores y grifería

134100108

27,35

Tres Cleaner. Limpiador de grifería para baño y cocina. + Mango telescópico para limpieza.



Caja de 16 unidades. Conjunto completo para el mantenimiento y limpieza de rociadores y grifería

13410010816

394,00

Tres Cleaner. Limpiador de grifería para baño y cocina. + Mango telescópico para limpieza.



ANEXO

Instalación recomendada	520
Recambios	524
Listado de referencias	528
Condiciones de venta	540



INSTALACIÓN RECOMENDADA

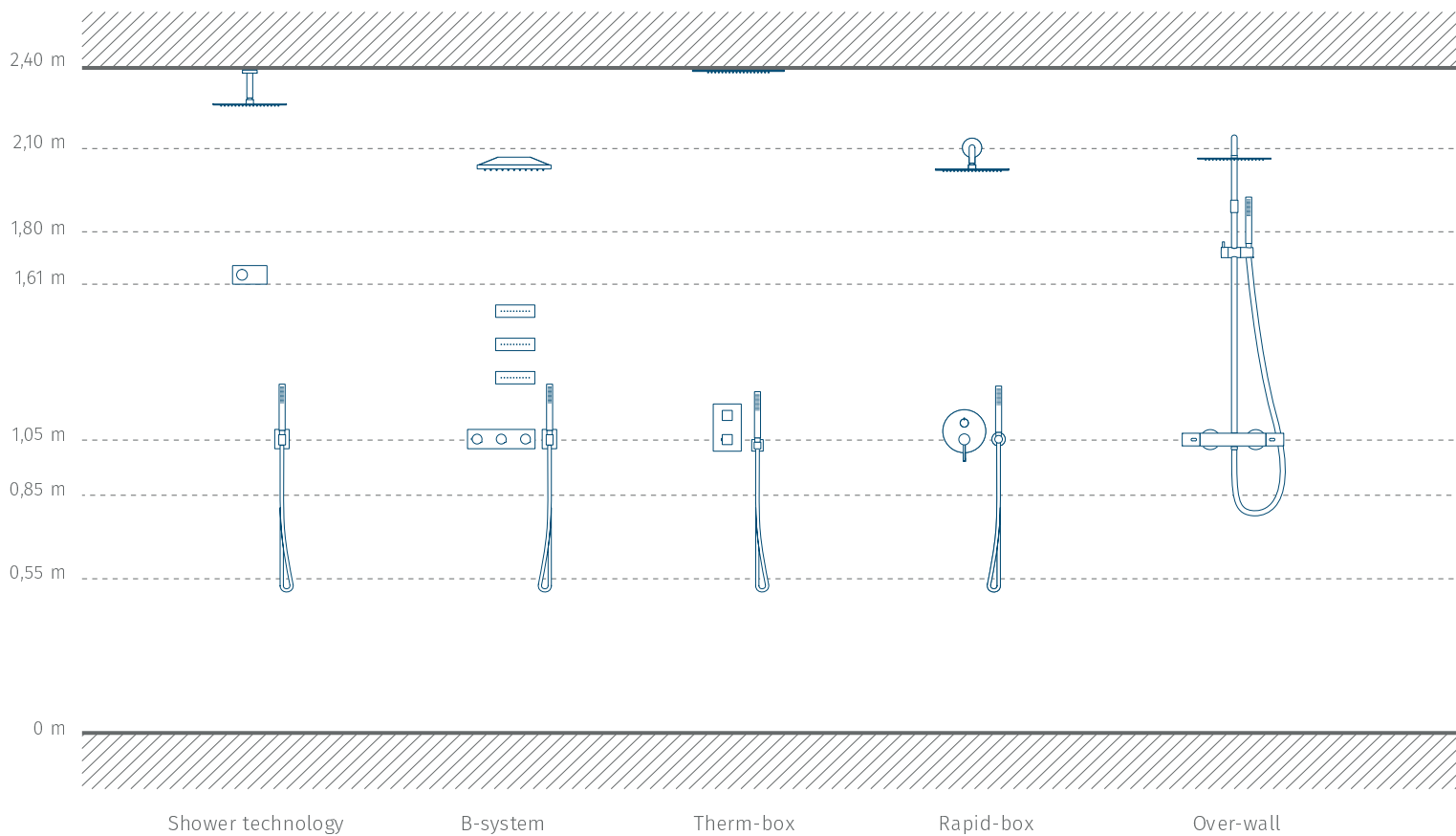



Desagües de ducha o bañera

Se podrán utilizar grifos con 2 salidas de agua al mismo tiempo siempre que el desagüe esté calculado para ello. (Tres recomienda el desagüe ref. 1 04 840)

Suministro de agua

El caudal de cada producto puede necesitar distintas presiones, pero con una presión dinámica de entre 2 y 3 bar sería suficiente. La presión dinámica se mide con el grifo abierto.

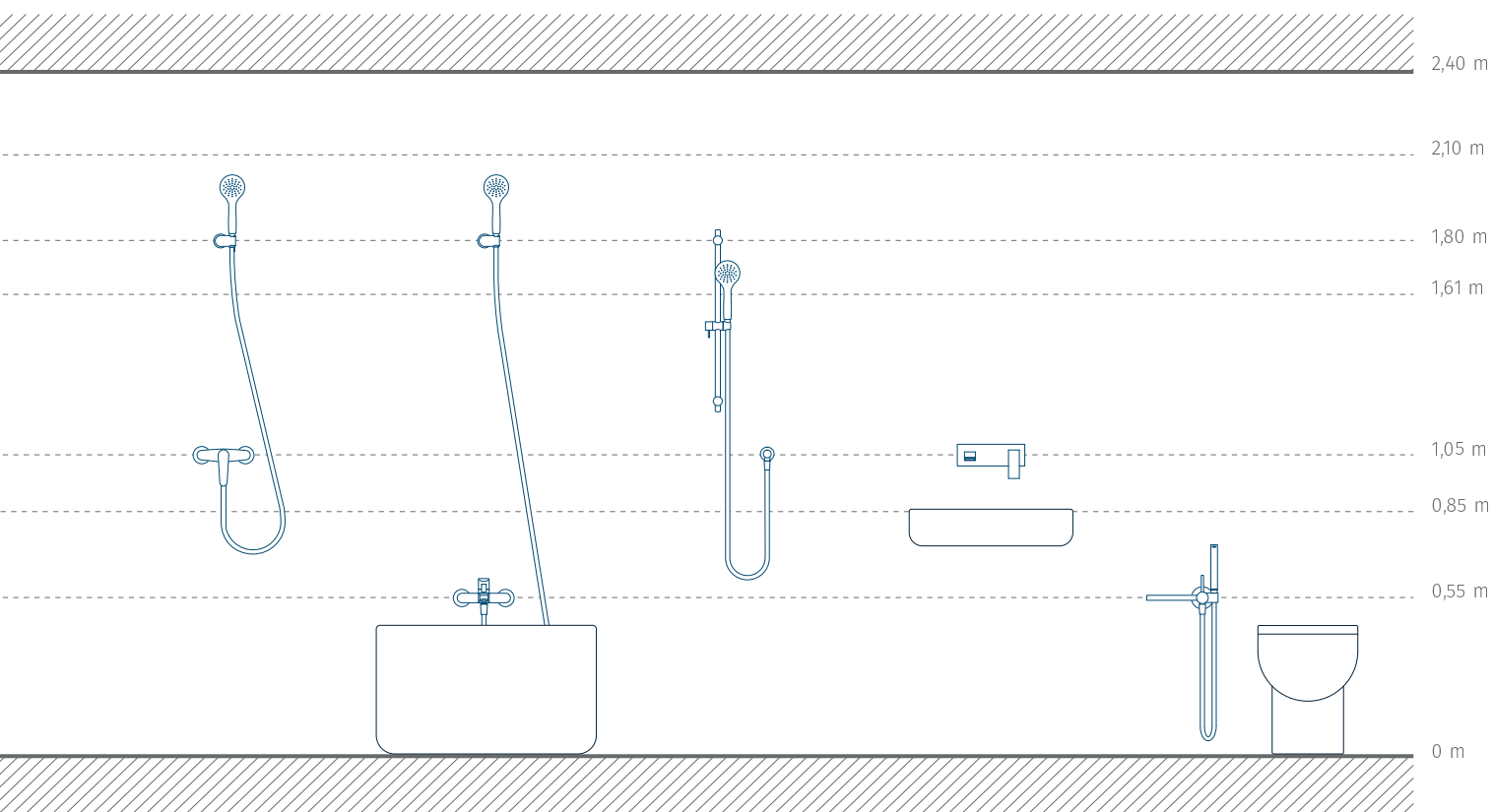

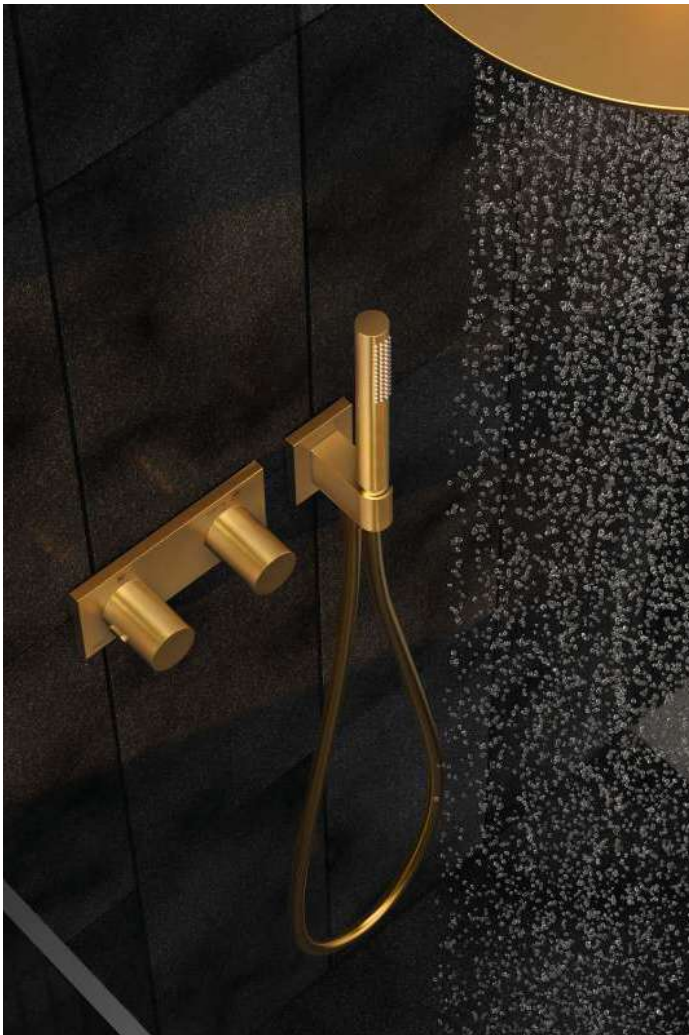

Nuevos diseños de volantes

B-SYSTEM

THERM-BOX

OVER-WALL



Volante cuadrado



Volante cuadrado-redondo



Volante con bordes redondeados



Volante ovalado





































Volante redondo



Volante en cruz



Visite nuestra página web para encontrar más recambios y planos de despiece de la grifería































	Aireador Cascade SLC. 24 Macho	9134673 9134673503 9134673501	5,00 10,00 10,00		Limitador de caudal. 24 Macho. Caudal: 8 l/min.	9134682	7,00
	Aireador 18 Macho	9262503	6,00		Limitador de caudal. 24 Macho. Caudal: 5 l/min.	91346825	7,00
	Aireador Cascade SLC 22 Hembra	9134672 9134672501	5,00 10,00		Aireador + Casquillo. 24 Macho. Caudal: 5 l/min.	23461305	7,00
	Aireador 24 Macho. Retención "C"	29966310	4,00		Limitador de caudal. 22 Hembra. Caudal: 6 l/min.	91346816	5,00
	Aireador 28 Macho	9134674	6,00		Limitador de caudal. 22 Hembra. Caudal: 8 l/min.	9134681	7,00
	Aireador oculto rectangular + llave	9106006	8,00		Limitador de caudal. 22 Hembra. Caudal: 5 l/min.	91346815	7,00
	Aireador enrasado 24 Macho	29961001	4,00		Aireador. 22 Hembra + Casquillo. Caudal: 4,5 l/min.	23466205	5,00
	Aireador enrasado 16 Macho. Caudal: 8 l/min.	29961002	5,00		Aireador enrasado. 24 Macho. Caudal: 4,5 l/min.	23461015	5,00
	Aireador 16 Macho. Caudal: 5 l/min.	29961005	5,00		Aireador enrasado. 24 Macho. Caudal: 3,8 l/min.	23461013	5,00
	Aireador oculto 16,5 Macho + llave	9134665	5,50		Rompeaguas enrasado. 24 Macho + Casquillo. Caudal: 1,9 l/min.	23466001	5,00
	Aireador oculto 16,5 Macho + llave	9134666	5,50		Aireador enrasado. 16,5 Macho. Caudal: 4,5 l/min.	23461050	5,00
	Rompeaguas enrasado. 24 Macho + llave	9134668	5,50		Aireador enrasado. 24 Macho. Caudal: 4,5 l/min.	23444005	5,00
	Rompeaguas enrasado y orientable. 24 Macho. + llave	29961006	5,50		Aireador enrasado. 24 Macho. Caudal: 3,8 l/min.	23461303	5,00
	Rótula bidé completa 16,5 + llave	9107672	11,60		Aireador enrasado. 24 Macho. Caudal: 1,9 l/min.	23461301	5,00
	Rótula 22 + Aireador	9134577	6,40		Aireador. 22 Hembra + Casquillo. Caudal: 3,8 l/min.	23466203	5,00
	Rótula 24 + Aireador	9134677	6,00		Aireador enrasado. 16,5 Macho. Caudal: 4,5 l/min.	23461501	5,00
	Limitador de caudal. 24 Macho. Caudal: 6 l/min.	91346826	5,00		Aireador enrasado. 16,5 Macho. Caudal: 3,8 l/min.	23461380	5,00























	23466905	5,00
	23466938	5,00
	23467205	5,00
	23467238	5,00
	23461038	5,00
	9134683	7,50
	23468301	7,50
	23468303	7,50
	913214591	120,00
Caño fijo para borde bañera sin distribuidor		
	9174441	30,00
	9134314	20,00
	9134315	25,00
	9134316	30,00
	9134319	35,00
	9134441	30,00
	9134880	27,00
	9134849	30,00

	913043810	35,00
	9134481	70,00
	913049310	35,00
	9133317	5,80
	29919505	60,00
	29919001	43,00
	9130190	40,00
	910719005	40,00
	9134591	40,00
	9134592	40,00
	9134288	40,00
	9134290	40,00
	9134235	46,00
	9194283	46,00
	9194552	120,00
	29916901	59,00
Cartucho termostático Instant 57		
	29916902	66,00
Cartucho termostático Instant 77		



RECAMBIOS

	Inversor 2 vías monomando 180	916218005	30,00		Montura cerámica izquierda (Hot) Retro-tres	913427210	15,00
	Inversor 2 vías monomando 180	29955304	30,00		Tubo flexible Macho 8x1 - R3/8" Long. 600 mm.	29908405	10,75
	Inversor 2 vías monomando 180	910618020	30,00		Tubo flexible Macho 8x1 - R3/8" Long. 450 mm.	29908406	8,75
	Inversor 2 vías Mono-term	29955303	30,00		Tubo flexible Macho 9x1 Long. 370 mm.	9134803	8,50
	Inversor automático bañera mural	9134256	11,30		Tubo flexible Macho 10x1 - R3/8" Long. 370 mm.	9134806	7,50
	Inversor automático bañera mural	9134250	11,30		Conjunto varilla y pulsador	913484007	9,35
	Inversor automático bañera mural - Essential	29955306	11,30		Desagüe automático + Varilla	913484057	25,35
	Montura R1/2" Llave de paso ESE-23	9134286	8,00		Desagüe automático + Varilla	913427510	24,65
	Montura R1/2" Llave de paso	9134296	15,00		Tapón para válvula de desagüe automático. Tapón: Ø 63 mm.	913484026	15,00
	Montura R1/2" Standard	9134284	7,00		Tapón para válvula de desagüe automático	913484016	10,00
	Montura R1/2"	9134294	9,00		Unión de las varillas para válvula de desagüe automático	913484005	2,65
	Montura cerámica R1/2"	9134282	15,00		Varilla larga horizontal para válvula de desagüe automático	9134840061	9,00
	Montura cerámica R1/2" Eje corto	9134292	15,00		Base soporte para grifo de cocina	963033331	3,60
	Montura cerámica R1/2" Eje largo	9134293	15,00		Conjunto bloqueo 6x1 Macho Long. 120 mm.	919260634	11,00
	Montura R3/8"	9134283	7,00		Conjunto bloqueo 8x1 Macho Long. 110 mm.	966110301	8,60
	Montura cerámica 16 Macho	9162292	15,00		Conjunto bloqueo 8x1 Macho Long. 250 mm.	916184010	20,00
	Montura cerámica derecha (Cold) Retro-tres	913427220	15,00		Conjunto bloqueo 8x1 Macho Long. 70 mm.	913010334	6,80

	Tornillo fijación caño fundido y caño de tubo. 6x1 Macho	9133317031	2,00		Llave multiusos + suplemento cartucho Mono-term	29989601	18,00
	Tornillo fijación caño fundido y caño de tubo. 6x1 Macho. Pack 10 unidades	913331703	10,00		Casquillo caño tubo	29919607	1,70
	Tornillo fijación palanca monomando. 5 Macho. Pack 10 unidades	913400831	7,50		Filtro termostática	919416401	2,20
	Tornillo fijación palanca monomando. 5 Macho	9134008311	1,50		Junta tórica NBR 17,17x1,78 mm.	9534294501	1,40
	Tapón soporte de cadena	932010331	1,85		Junta tórica NBR 70SH 18x2,2 mm.	9533315501	1,40
	Bote de grasa	9134882	5,50		Junta tórica NBR 70SH 18x2,2 mm. Pack 10 unidades	953331550	7,00
	Llave aireador oculto 16,5 Macho	9134895	1,85		Junta tórica NBR 70SH 41x2,5 mm.	9530440521	1,40
	Llave aireador oculto 18,5 Macho	9134896	1,85		Juntas tóricas NBR 70SH 41x2,5 mm. Pack 10 unidades	953044052	7,00
	Llave aireador oculto 24 Macho	9134897	1,85		Junta tórica EPDM 70SH 18,72x2,62 mm.	9533317501	1,40
	Llave aireador oculto rectangular	9134898	2,20		Juntas tóricas EPDM 70SH 18,72x2,62 mm. Pack 10 unidades	953331750	7,00
	Llave aireadores	9134891	6,35				
	Regulador del sensor para grifería electrónica	299392134	10,00				
	Llave allen 2,5 mm.	919210318	1,90				
	Llave bloqueo tuerca	9134893	2,20				
	Llave distribuidor monomando empotrado	29989603	19,50				
	Llave multiusos	9134890	10,00				
	Llave multiusos + suplemento cartucho Loft	29989602	16,00				



REFERENCIA	€	Pág.	REFERENCIA	€	Pág.	REFERENCIA	€	Pág.	REFERENCIA	€	Pág.	REFERENCIA	€	Pág.
00			00620101OM	324,00	76	00628006	469,00	319	00661002	298,00	75	030336AC	363,00	446
00610101	155,00	75	00620101OR	324,00	76	00628006AC	727,00	85	00663901	45,00	381	030336BM	363,00	446
00610101AC	240,00	75	00620501AC	388,00	77	00628006AC	727,00	319	00663901AC	69,75	381	03035501	300,00	459
00610101BL	240,00	75	00620501BM	388,00	77	00628006BM	727,00	85	00663901BM	69,75	381	03043401	178,00	461
00610101BM	240,00	75	00620501NM	388,00	77	00628006BM	727,00	319	00663901KMB	69,75	381	03043801	182,00	462
00610101DM	177,00	75	00620501OM	500,00	77	00628006NM	727,00	85	00663901NM	69,75	381	03044401	198,00	461
00610101NE	240,00	75	00620501OR	500,00	77	00628006NM	727,00	319	00663901OM	90,00	381	03045501	240,00	459
00610101NM	240,00	75	00625001	130,00	256	00628006OM	938,00	85	00663901OP	90,00	381	03048501	294,00	467
00610101OM	310,00	75	00625001AC	202,00	256	00628006OR	938,00	319	00663901OPM	90,00	381	03048701	430,00	457
00610101OR	310,00	75	00625001BM	202,00	256	00628006OR	938,00	85	00663901OR	90,00	381	03049301	284,00	467
00610102	155,00	75	00625001NM	202,00	256	00630001	242,00	79	00681001AC	566,00	76	030496BM	457,00	444
00610102D	177,00	75	00625001OM	260,00	256	00630001AC	375,00	79	00681001BL	566,00	76	030496OM	590,00	444
00611001	265,00	76	00625001OR	260,00	256	00630001BM	375,00	79	00681001BM	566,00	76	030497BM	457,00	444
00611001BL	411,00	76	00625003	603,00	90	00630001NM	375,00	79	00681001NE	566,00	76	030497NM	457,00	444
00611001D	287,00	76	00625003AC	935,00	90	00630001OM	484,00	79	00681001NM	566,00	76	030497OM	590,00	444
00611001NE	411,00	76	00625003AC	935,00	263	00630001OR	484,00	79	00681001OM	730,00	76	030498BM	465,00	444
00611002	265,00	76	00625003BM	935,00	90	00630002	252,00	79	00681001OR	730,00	76	030498NM	465,00	444
00611002BL	411,00	76	00625003BM	935,00	263	00630002AC	391,00	79	00681002	365,00	75	030498OM	600,00	444
00611002D	287,00	76	00625003NM	935,00	90	00630002BM	391,00	79	00698003	596,00	86	03411601	40,00	381
00611002NE	411,00	76	00625003NM	935,00	263	00630002NM	391,00	79	00698003	596,00	328	03411601AC	62,00	381
00612001	158,00	80	00625003OM	1.206,00	90	00630002OM	504,00	79	00712001	158,00	80	03411601BM	62,00	381
00612001AC	245,00	80	00625003OM	1.206,00	263	00630002OR	504,00	79	00712001AC	245,00	80	03411601KMB	62,00	381
00612001BL	245,00	80	00625003OR	1.206,00	90	00630003	295,00	79	00712001BL	245,00	80	03411601NM	62,00	381
00612001BM	245,00	80	00625003OR	1.206,00	263	00630003AC	457,00	79	00712001BM	245,00	80	03411601OM	62,00	381
00612001D	180,00	80	00625004	624,00	90	00630003BM	457,00	79	00712001D	180,00	80	03411601OPM	80,00	381
00612001NE	245,00	80	00625004	624,00	259	00630003NM	457,00	79	00712001NE	245,00	80	03411601OP	80,00	381
00612001NM	245,00	80	00625004AC	967,00	90	00630003OM	590,00	79	00712001NM	245,00	80	03411601OPM	80,00	381
00612001OM	316,00	80	00625004AC	967,00	259	00630003OR	590,00	79	00712001OM	316,00	80	03411601OR	80,00	381
00612001OR	316,00	80	00625004BM	967,00	90	006300011	275,00	78	00712001OR	316,00	80	03412102	155,00	367
00612301	190,00	81	00625004BM	967,00	259	00630011AC	426,00	78	00715501	85,00	91	03412401	35,00	152
00612301AC	295,00	81	00625004NM	967,00	90	00630011BM	426,00	78	00715501AC	132,00	91	03412401	35,00	100
00612301BM	295,00	81	00625004NM	967,00	259	00630011NM	426,00	78	00715501BM	132,00	91	03412401	35,00	138
00612301NM	295,00	81	00625004OM	1.248,00	90	00630011OM	550,00	78	00715501NM	132,00	91	03412401	35,00	64
00612301OM	380,00	81	00625004OM	1.248,00	259	00630011OR	550,00	78	00715501OM	170,00	91	03412401AC	54,25	100
00612301OR	380,00	81	00625004OR	1.248,00	90	00630012	285,00	79	00715501OR	170,00	91	03412401AC	54,25	64
00612302	230,00	81	00625004OR	1.248,00	259	00630012AC	442,00	79	00716703BM	462,00	81	03412401BM	54,25	100
00612302AC	357,00	81	00625005	1.137,00	265	00630012BM	442,00	79	00716703NM	462,00	81	03412401BM	54,25	64
00612302BM	357,00	81	00625005AC	1.762,00	265	00630012NM	442,00	79	00716703OM	596,00	81	03412401KMB	54,25	64
00612302NM	357,00	81	00625005AC	1.762,00	265	00630012OM	570,00	79	00716703OR	596,00	81	03412401NM	54,25	64
00612402AC	344,00	80	00625005BM	1.762,00	265	00630012OR	570,00	79	0071700203BM	493,00	81	03412401NM	54,25	100
00612402BM	344,00	80	00625005NM	1.762,00	265	00630013	325,00	79	0071700203NM	493,00	81	03412401NM	54,25	64
00612402OM	444,00	80	00625005OR	2.274,00	265	00630013AC	504,00	79	0071700203OM	636,00	81	03412401OM	70,00	100
00612402OR	444,00	80	00625005OR	2.274,00	265	00630013BM	504,00	79	0071700203OR	636,00	81	03412401OM	70,00	64
00613001	135,00	80	00625006	529,00	268	00630013NM	504,00	79	00719101	633,00	82	03412401OP	70,00	64
00613001AC	209,00	80	00625006AC	820,00	268	00630013OM	650,00	79	00719101	633,00	338	03412401OPM	70,00	64
00613001BM	209,00	80	00625006BM	820,00	268	00630013OR	650,00	79	00719102	667,00	82	03412401OR	70,00	100
00613001NM	209,00	80	00625006NM	820,00	268	006437BM	628,00	460	00719102	667,00	338	03412401OR	70,00	64
00613001OM	270,00	80	00625006OM	1.058,00	268	006437NM	628,00	460	00719701	585,00	83	03412402	45,00	81
00613001OR	270,00	80	00625006OR	1.058,00	268	006437OM	810,00	460	00719701	585,00	339	03412402AC	69,75	81
00616103	450,00	349	00628003	542,00	84	00648501	290,00	77	00719702	616,00	82	03412402BM	69,75	81
00616103AC	450,00	88	00628003AC	840,00	313	00648501AC	450,00	77	00719702	616,00	339	03412402NM	69,75	81
00616103AC	698,00	349	00628003AC	840,00	313	00648501BM	450,00	77	00750301AC	233,00	78	03412402OM	90,00	81
00616103AC	698,00	88	00628003BM	840,00	84	00648501NM	450,00	77	00750301BM	233,00	78	03412402OR	90,00	81
00616103BM	698,00	349	00628003BM	840,00	313	00648501OM	580,00	77	00750301NM	233,00	78	03423101	163,00	370
00616103BM	698,00	88	00628003NM	840,00	84	00648501OR	580,00	77	00750301OM	300,00	78	03433603	115,00	395
00616103NM	698,00	349	00628003NM	840,00	313	006486BM	620,00	444	00750301OR	300,00	78	03433604	150,00	395
00616103NM	698,00	88	00628003OM	1.084,00	84	006486NM	620,00	444				03443101	343,00	370
00616103OM	900,00	349	00628003OR	1.084,00	313	006486OM	800,00	444				03443202	265,00	366
00616103OM	900,00	88	00628003OR	1.084,00	313	00648701	475,00	457	01210002	76,00	473	03443203	415,00	366
00616103OR	900,00	349	00628004	564,00	84	00648701AC	736,00	457	01210003	79,00	473	03450101	24,50	481
00616103OR	900,00	88	00628004AC	874,00	84	00648701BM	736,00	457	01210302	87,00	472	03450102	25,00	481
00616104	450,00	348	00628004AC	874,00	309	00648701NM	736,00	457	01210303	90,00	472	03452602	115,00	394
00616104	450,00	87	00628004AC	874,00	309	00660502AC	375,00	78	01217901	455,00	476	03452702	150,00	394
00616105	440,00	349	00628004BM	874,00	84	00660502BM	375,00	78	01220002	70,00	474	03453420AC	46,50	491
00616105	440,00	87	00628004BM	874,00	309	00660502NM	375,00	78	01220702	210,00	436	03453420BM	46,50	491
00616105AC	682,00	349	00628004NM	874,00	84	00660502OM	484,00	78	01220801	76,00	474	03453420KM	46,50	491
00616105AC	682,00	87	00628004NM	874,00	309	00660502OR	484,00	78	01221701	298,00	436	03453420KMB	46,50	491
00616105BM	682,00	349	00628004OM	1.12										

REFERENCIA	€	Pág.	REFERENCIA	€	Pág.	REFERENCIA	€	Pág.	REFERENCIA	€	Pág.	REFERENCIA	€	Pág.
03453440AC	143,00	492	03474601LM	42,00	490	06122001D	146,00	137	06228004	414,00	139	09226301LV	1.661,00	38
03453440NM	143,00	492	03474601OM	60,00	490	06144701	265,00	432	06228004	414,00	311	09226301OR	2.097,00	38
03453440OM	184,00	492	03474601OR	60,00	490	06144701	265,00	135	06228005	820,00	140	09226302	1.290,00	38
03453440OR	184,00	492	03483102	335,00	367	06144801	295,00	433	06228005	820,00	318	09226302AC	1.706,00	38
03463430AC	72,00	494	03493101	191,00	397	06144801	295,00	135	06228006	333,00	140	09226302LM	1.629,00	38
03463430BM	72,00	494	03493101AC	296,00	397	06151101	88,00	498	06228006	333,00	320	09226302LV	1.629,00	38
03463430KM	72,00	494	03493101BM	296,00	397	06151101	88,00	179	06228110	95,00	139	09226302OR	2.026,00	38
03463430KMB	72,00	494	03493101NM	296,00	397	06151101	88,00	159	06228110	95,00	307	09244501AC	335,00	468
03463430LM	72,00	494	03493199	138,00	394	06151101	88,00	105	06230001	220,00	136	09244501AC	335,00	437
03463430LV	72,00	494	03493199AC	214,00	394	06151101	88,00	145	06230002	230,00	136	09244601	300,00	468
03463430NM	72,00	494	03493199BM	214,00	394	06151101BM	136,00	498	06230011	240,00	136	09244601	300,00	437
03463430OM	192,00	494	03493199NM	214,00	394	06151101BM	136,00	105	06230012	250,00	136	09286302	2.862,00	426
03463430OP	192,00	494	03493201	198,00	397	06151101KM	136,00	498	06243201	83,00	378	09286302	2.862,00	238
03463430OPM	192,00	494	03493201AC	307,00	397	06151101KMB	136,00	498	06243201AC	129,00	378	09286304	2.142,00	427
03463430OR	192,00	494	03493201BM	307,00	397	06151101NM	136,00	498	06243201BM	129,00	378	09286307	1.598,00	426
03463501	110,00	279	03493201NM	307,00	397	06151101NM	136,00	498	06243201KM	129,00	378	09286307	1.598,00	238
03463501AC	171,00	279	03493299	145,00	394	06151101OM	176,00	498	06243201KMB	129,00	378	09286308	1.534,00	426
03463501BM	171,00	279	03493299AC	225,00	394	06151101OM	176,00	105	06243201NM	129,00	378	09286308	1.534,00	238
03463501KMB	171,00	279	03493299BM	225,00	394	06151101OP	176,00	498	06243201OP	166,00	378	09286308OM	2.361,00	426
03463501NM	171,00	279	03493299NM	225,00	394	06151101OPM	176,00	498	06243201OP	166,00	378	09286308OM	2.361,00	238
03463501OM	220,00	279	03944401	198,00	461	06151101OR	176,00	498	06243201OPM	166,00	378	09286308OPM	2.361,00	426
03463501OPM	220,00	279				06151101OR	176,00	105	06243201OR	166,00	378	09286308OPM	2.361,00	238
03463502	100,00	279	06			06163504	297,00	401	062435AC	403,00	445	09286315	1.910,00	427
03463502AC	155,00	279	06110301	104,00	133	06163505	243,00	401	062435BM	403,00	445	09286315	1.910,00	239
03463502BM	155,00	279	06110301D	126,00	133	06163506	320,00	402	062435NM	403,00	445	09286402	3.446,00	428
03463502KMB	155,00	279	06110302	121,00	134	06163509	295,00	403	062435OM	520,00	445	09286402	3.446,00	240
03463502NM	155,00	279	06110302D	143,00	134	06183901AC	42,65	404	06243601AC	349,00	446	09286404	2.726,00	428
03463502OM	200,00	279	06110501	265,00	60	06183901BM	42,65	404	06243601BM	349,00	446	09286408	2.118,00	428
03463502OPM	200,00	279	06110501AC	411,00	60	06183901KM	42,65	404	06243601NM	349,00	446	09286551	1.318,00	422
03463505	150,00	280	06110501BM	411,00	60	06183901KMB	42,65	404	06243601OM	450,00	446	09286551	1.318,00	234
03463505AC	233,00	280	06110501KM	411,00	60	06183901NM	42,65	404	06248702	420,00	457	09286551	1.318,00	422
03463505BM	233,00	280	06110501KMB	411,00	60	06183901OM	55,00	404	06248801	240,00	445	09286551	1.318,00	234
03463505KMB	233,00	280	06110501NM	411,00	60	06183901OPM	55,00	404	06250301	62,00	218	09286551	1.318,00	422
03463505NM	233,00	280	06110501OM	530,00	60	06183901OR	55,00	404	06254201	215,00	447	09286551	1.318,00	234
03463505OM	300,00	280	06110501OP	530,00	60	06192801	112,00	396	06254201AC	333,00	447	09286551	1.318,00	422
03463505OPM	300,00	280	06110501OPM	530,00	60	06193102	130,00	397	06254201BM	333,00	447	09286551	1.318,00	234
03463506	140,00	280	06110501OR	530,00	60	06193103	127,00	398	06254201NM	333,00	447	09286551	1.318,00	422
03463506AC	217,00	280	06110502	280,00	60	06193104	150,00	398	06254201OM	430,00	447	09286552	1.540,00	424
03463506BM	217,00	280	06110502AC	434,00	60	06193105	147,00	398	06260301	60,00	219	09286552	1.540,00	236
03463506KMB	217,00	280	06110502BM	434,00	60	06210301	104,00	133	06298001	489,00	330	09286552	1.540,00	424
03463506NM	217,00	280	06110502KM	434,00	60	06210301D	126,00	133	06298001	489,00	142	09286552	1.540,00	236
03463506OM	280,00	280	06110502KMB	434,00	60	06210302	121,00	134	06298004	427,00	330	09286552	1.540,00	424
03463506OPM	280,00	280	06110502NM	434,00	60	06210302D	143,00	134	06298004	427,00	141	09286552	1.540,00	236
03463701	84,00	391	06110502OM	560,00	60	06212001	107,00	137	06298004	427,00	449	09286552	1.540,00	424
03463701AC	130,00	391	06110502OP	560,00	60	06212001AC	260,00	63	06944401	198,00	461	09286552	1.540,00	236
03463701BM	130,00	391	06110502OPM	560,00	60	06212001BM	260,00	63	06944701	98,50	450	09286552	1.540,00	424
03463701NM	130,00	391	06110502OR	560,00	60	06212001D	129,00	137				09286552	1.540,00	236
03463702	62,50	392	06112001	107,00	137	06212001KM	260,00	63	07			09286552	1.540,00	424
03463706	32,00	393	06112001AC	260,00	63	06212001KMB	260,00	63	07032003	96,00	454	09286552	1.540,00	236
03463708	92,50	392	06112001BM	260,00	63	06212001NM	260,00	63	07044802	105,00	452	09286552	1.540,00	424
03463820AC	76,00	494	06112001D	129,00	137	06212001OM	336,00	63	07099501	298,00	480	09286552	1.540,00	236
03463820BM	76,00	494	06112001KM	260,00	63	06212001OP	336,00	63				09286552	1.540,00	424
03463820KMB	76,00	494	06112001KMB	260,00	63	06212001OPM	336,00	63	08			09286552	1.540,00	236
03463820LM	76,00	494	06112001NM	260,00	63	06212001OR	336,00	63	081192	387,00	154	09286552	1.540,00	424
03463820LV	76,00	494	06112001OM	336,00	63	06212001TAM	260,00	63	081192	387,00	341	09286552	1.540,00	236
03463820NM	76,00	494	06112001OP	336,00	63	06212001TRO	260,00	63	08119301	414,00	155	09286552	1.540,00	424
03463820OM	204,00	494	06112001OPM	336,00	63	06213001	125,00	137	08119301	414,00	342	09286552	1.540,00	236
03463820OP	204,00	494	06112001OR	336,00	63	06216102	380,00	352	08119302	421,00	155	09286552	1.540,00	424
03463820OPM	204,00	494	06112001TAM	260,00	63	06216102	380,00	143	08119302	421,00	342	09286552	1.540,00	236
03463820OR	204,00	494	06112001TRO	260,00	63	06216103	370,00	352	08119701	489,00	156	09286552	1.540,00	424
03463901	38,00	381	06115501	80,00	498	06216103	370,00	143	08119701	489,00	343	09286552	1.540,00	236
03463901AC	58,90	381	06115501	80,00	179	06217702	110,00	325	08119702	498,00	154	09286552	1.540,00	424
03463901BL	58,90	381	06115501	80,00	159	06217702	110,00	141	08119702	498,00	341	09286552	1.540,00	236
03463901BM	58,90	381	06115501	80,00	105	06218002	170,00	327	08119703	466,00	153	09286552	1.540,00	424
03463901KMB	58,90	381	06115501	80,00	145	06218002	170,00	141	08119703	466,00	340	09286552	1.540,00	236
03463901NE	58,90	381	06115501BM	124,00	498	06218080	456,00	333	08119704	496,00	155	09286552	1.540,00	424
03463901NM	58,90	381	06115501BM	124,00	105	06218080	456,00	133	08119704	496,00	342	09286552	1.540,00	236
03463901OM	76,00	381	06115501KM	124,00	498	06218081	394,00	342	08120001	230,00	150	09286552	1.540,00	424
03463901OP	76,00	381	06115501KMB	124,00	498	06218081	394,00	142	08120021	240,00	151	09286552	1.540,00	236
03463901OPM	76,00	381	06115501NM	124,00	498	06220301	119,00	133	08333301	164,00	451	09286552	1.540,00	424
03463901OR	76,00	381	06115501NM	124,00	105	06220301D	141,00	133				09286552	1.540,00	236
03464501	140,00	280	06115501OM	160,00	498	06220304	207,00	134	09			09286552	1.540,00	424
03464501AC	217,00	280	06115501OM	160,00	105	06220601	207,00	134	09217101	260,00	432	09286552	1.540,00	236
03464501BM	217,00													

REFERENCIA	€	Pág.	REFERENCIA	€	Pág.	REFERENCIA	€	Pág.	REFERENCIA	€	Pág.	REFERENCIA	€	Pág.
09288555NM	1.942,00	237	107181	195,00	501	123215	72,50	464	13413730	248,00	375	134315010OR	280,00	375
09288556NM	1.502,00	425	10723601	65,00	414	123217	92,00	465	13413730AC	384,00	375	134315011	142,00	373
09288556NM	1.502,00	237	10723601AC	101,00	414	123230	76,50	464	13413730BM	384,00	375	134315012	167,00	373
09288557NM	2.190,00	424	10723601BM	101,00	414	123306	50,00	469	13413730KM	384,00	375	134315012AC	259,00	373
09288557NM	2.190,00	236	10723601KM	101,00	414	123310	72,50	464	13413730KMB	384,00	375	134315012BM	259,00	373
09288558NM	1.239,00	422	10723601KMB	101,00	414	123314	72,00	463	13413730NM	384,00	375	134315012KM	259,00	373
09288558NM	1.239,00	234	10723601NM	101,00	414	123315	73,00	464	13413730OM	496,00	375	134315012KMB	259,00	373
09288561NM	2.200,00	424	10723601OM	130,00	414	123317	94,00	465	13413730OP	496,00	375	134315012NM	259,00	373
09288561NM	2.200,00	236	10723601OP	130,00	414	123330	77,00	465	13413730OPM	496,00	375	134315012OM	334,00	373
09288563NM	1.282,00	422	10723601OPM	130,00	414	123342	73,00	463	13413730OR	496,00	375	134315012OP	334,00	373
09288563NM	1.282,00	234	10723601OR	130,00	414	123360	81,00	465	13413826	80,00	374	134315012OPM	334,00	373
09288564NM	1.234,00	423	10723603	65,00	414	123416	90,00	465	13413830	260,00	373	134315012OR	334,00	373
09288564NM	1.234,00	235	10723603AC	101,00	414	123500C	24,00	223	13413830AC	403,00	373	134315014	215,00	372
09288567NM	1.190,00	423	10723603BM	101,00	414	123500F	24,00	223	13413830BM	403,00	373	134315015	167,00	374
09288567NM	1.190,00	235	10723603KM	101,00	414	123505	38,50	469	13413830KMB	403,00	373	13431513	45,00	376
			10723603KMB	101,00	414	123506	38,50	469	13413830KMB	403,00	373	134331	173,00	367
			10723603NM	101,00	414	123510C	57,00	222	13413830NM	403,00	373	13434010	29,20	485
			10723603OM	130,00	414	123510F	57,00	222	13413830OM	520,00	373	13434020	29,00	489
			10723603OP	130,00	414	123511C	30,00	224	13413830OP	520,00	373	13434120	29,00	487
			10723603OPM	130,00	414	123511F	30,00	224	13413830OPM	520,00	373	134432	215,00	371
			10723603OR	130,00	414	123512C	29,00	224	13413830OR	520,00	373	134433	255,00	370
			10723606	30,00	414	123512F	29,00	224	13413940	88,00	377	134445	95,00	353
			10723606AC	46,50	414	123513C	28,00	225	13413940AC	136,00	377	134512	102,00	395
			10723606BM	46,50	414	123513F	28,00	225	13413940BM	136,00	377	13451501	450,00	409
			10723606KM	46,50	414	123515	42,00	224	13413940NM	136,00	377	13451501AC	698,00	409
			10723606KMB	46,50	414	123520C	35,00	223	13413940OM	176,00	377	13451501BM	698,00	409
			10723606NM	46,50	414	123520F	35,00	223	13413940OR	176,00	377	13451501KM	698,00	409
			10723606OM	60,00	414	12423601	78,00	416	13416703	76,00	477	13451501KMB	698,00	409
			10723606OP	60,00	414	12423601AC	121,00	416	13416803	98,00	477	13451501NM	698,00	409
			10723606OPM	60,00	414	12423601LM	109,00	416	134184	35,00	415	13451501OM	900,00	409
			10723606OR	60,00	414	12423601LV	109,00	416	134184AC	54,25	415	13451501OP	900,00	409
			10723620	25,00	414	12423601OR	156,00	416	134184BM	54,25	415	13451501OPM	900,00	409
			10723620AC	38,75	414	12423603	78,00	416	134184KM	54,25	415	13451501OR	900,00	409
			10723620BM	38,75	414	12423603AC	121,00	416	134184KMB	54,25	415	134516	66,00	390
			10723620KM	38,75	414	12423603LM	109,00	416	134184NM	54,25	415	134517	98,00	390
			10723620KMB	38,75	414	12423603LV	109,00	416	134184OM	70,00	415	134520	98,00	390
			10723620NM	38,75	414	12423603OR	156,00	416	134184OP	70,00	415	13452102	48,00	379
			10723620OM	50,00	414	12423606	43,00	416	134184OPM	70,00	415	13452102AC	74,40	379
			10723620OP	50,00	414	12423606AC	66,65	416	134184OR	70,00	415	13452102BM	74,40	379
			10723620OPM	50,00	414	12423606LM	60,20	416	13420503	55,50	475	13452102KM	74,40	379
			10723620OR	50,00	414	12423606LV	60,20	416	134215023	5,00	405	13452102KMB	74,40	379
			107476	360,00	400	12423606OR	86,00	416	134215024	12,30	496	13452102NM	74,40	379
			107503	150,00	78	12423607	16,00	416	134215025	18,50	489	13452102NM	96,00	379
			107511	93,00	91	12423607AC	24,80	416	134215026	12,30	488	13452102OP	96,00	379
			107839	29,50	404	12423607LM	22,40	416	134215027	12,40	493	13452102OPM	96,00	379
			107839BM	45,75	404	12423607LV	22,40	416	134215028	18,50	488	13452102OR	96,00	379
			107839NM	45,75	404	12423607OR	32,00	416	134221	138,00	367	134522	137,00	395
			107839OM	59,00	404	12463609	76,00	416	134232	155,00	371	13452202	65,00	379
			107839OR	59,00	404				134233	168,00	370	13452202AC	101,00	379
			107922	66,00	390				13424010	22,00	487	13452202BM	101,00	379
			107926	357,00	399	130335	248,00	462	13424020	28,00	487	13452202NM	101,00	379
			107935	135,00	391	130336	234,00	446	13424030	23,50	487	13452202OM	130,00	379
			107940	62,00	485	130337	60,50	453	134301	85,00	503	13452202OR	130,00	379
						130481	270,00	466	134302	45,00	503	13453410	34,00	492
						130484	315,00	466	134303	49,00	503	13453420	30,00	491
						130495	442,00	466	134315001	55,00	376	13453430	67,00	491
						130496	295,00	444	134315002	75,00	374	13453440	92,00	492
						130497	295,00	444	134315003	100,00	375	13454010	24,20	485
						130498	300,00	444	134315004	120,00	373	13454030	36,70	487
						13315510C	60,00	225	134315005	125,00	375	13454050	21,00	486
						13315510F	60,00	225	134315006	145,00	373	13454060	24,00	486
						13315710C	72,00	225	134315007	200,00	372	13454070	17,00	486
						13315710F	72,00	225	134315007AC	310,00	372	13454110	21,00	488
						133516	54,00	225	134315007BM	310,00	372	13454160	24,00	488
						133517	56,00	225	134315007KMB	310,00	372	13454190	17,00	488
						134100106	12,35	517	134315007NM	310,00	372	134612	17,60	384
						134100106CB12	133,00	517	134315007OM	400,00	372	134617	14,50	385
						134100108	27,35	517	134315007OP	400,00	372	134618	50,00	391
						13410010816	394,00	517	134315007OPM	400,00	372	134619	68,00	391
						134122	218,00	138	134315007OR	400,00	372	13462101	62,00	377
						134123	218,00	64	134315008	250,00	372	13462102	58,00	379
						134122AC	338,00	64	134315008AC	388,00	372	13462102AC	89,90	379
						134122BM	338,00	64	134315008BM	388,00	372	13462102BM	89,90	379
						134122NM	338,00	64	134315008NM	388,00	372	13462102KMB	89,90	379
						134123	178,00	138	134315008OM	500,00	372	13462102NM	89,90	379
						134123AC	276,00	64	134315008OR	500,00	372	13462102OM	116,00	379
						134123BM	276,00	64	134315009	95,00	376	13462102OP	116,00	379
						134123KM	276,00	64	134315010	140,00	375	13462102OPM	116,00	379
						134123KMB	276,00	64	134315010AC	217,00	375	13462102OR	116,00	379
						134123NM	276,00	64	134315010BM	217,00	375	13462104	75,00	377
						134123OM	356,00	64	134315010KMB	217,00	375	13462104AC	116,00	377
						134123OP	356,00	64	134315010NM	217,00	375	13462104BM	116,00	377
						134123OPM	356,00	64	134315010OM	280,00	375	13462104KMB	116,00	377
						134123OR	356,00	64	134315010OP	280,00	375	13462104NM	116,00	377
						13413726	80,00	376	134315010OPM	280,00	375	13462104OM	150,00	377

REFERENCIA	€	Pág.	REFERENCIA	€	Pág.	REFERENCIA	€	Pág.	REFERENCIA	€	Pág.	REFERENCIA	€	Pág.
13462104OP	150,00	377	13495002KMB	1.271,00	365	16123602BM	93,00	415	181191	423,00	154	19016903BM	341,00	278
13462104OPM	150,00	377	13495002NM	1.271,00	365	16123602KM	93,00	415	181191	423,00	341	19016903KMB	341,00	278
13462104OR	150,00	377	13495002OM	1.640,00	365	16123602KMB	93,00	415	18119102	423,00	153	19016903NM	341,00	278
13462202	75,00	378	13495002OP	1.640,00	365	16123602NM	93,00	415	18119102	423,00	340	19016903OM	440,00	278
13462202AC	116,00	378	13495002OPM	1.640,00	365	16123602OM	120,00	415	181203	129,00	149	19016903OPM	440,00	278
13462202BM	116,00	378	13495002OR	1.640,00	365	16123602OP	120,00	415	181217	204,00	149	19016904	220,00	278
13462202NM	116,00	378	134950AC	1.542,00	365	16123602OPM	120,00	415	181222	216,00	152	19016904AC	341,00	278
13462202OM	150,00	378	134950BM	1.542,00	365	16123602OR	120,00	415	181223	176,00	152	19016904BM	341,00	278
13462202OR	150,00	378	134950NM	1.542,00	365	16123606	25,00	415	181341	150,00	448	19016904KMB	341,00	278
134627	16,00	386	134950OM	1.990,00	365	16123606AC	38,75	415	181436	200,00	445	19016904NM	341,00	278
134628	118,00	396	134950OR	1.990,00	365	16123606BM	38,75	415	181437	240,00	460	19016904OM	440,00	278
134629	133,00	396	134951	995,00	363	16123606KM	38,75	415	181438	245,00	460	19016904OPM	440,00	278
13463301	77,00	377	13495101	800,00	363	16123606KMB	38,75	415	181468	165,00	153	19016905	220,00	278
13463302	77,00	377	13495101AC	1.240,00	363	16123606NM	38,75	415	181474	185,00	153	19016905AC	341,00	278
13463303	75,00	377	13495101BM	1.240,00	363	16123606OM	50,00	415	181540	220,00	447	19016905BM	341,00	278
13463310	13,60	490	13495101KM	1.240,00	363	16123606OP	50,00	415	181903	108,00	149	19016905KMB	341,00	278
134633410	41,00	495	13495101KMB	1.240,00	363	16123606OPM	50,00	415	181920	111,00	151	19016905NM	341,00	278
134633410NM	63,55	495	13495101NM	1.240,00	363	16123606OR	50,00	415	183341	142,00	448	19016905OM	440,00	278
13463420	61,00	495	13495101OM	1.600,00	363	16123620	15,00	415	186103	126,00	149	19016905OPM	440,00	278
13463420NM	94,55	495	13495101OP	1.600,00	363	16123620AC	23,25	415	186120	129,00	151	19016906	270,00	278
13463430	30,00	494	13495101OPM	1.600,00	363	16123620BM	23,25	415	186203	151,00	149	19016906AC	419,00	278
13463440	22,10	496	13495101OR	1.600,00	363	16123620KM	23,25	415	186217	226,00	149	19016906BM	419,00	278
13463450	22,20	491	13495102	870,00	363	16123620KMB	23,25	415	186920	133,00	151	19016906NM	419,00	278
13463460	4,40	497	13495102AC	1.349,00	363	16123620NM	23,25	415	18718250	350,00	501	19016906OM	540,00	278
13463810	21,00	496	13495102BM	1.349,00	363	16123620OM	30,00	415				19017401	200,00	284
13463820	32,00	494	13495102KM	1.349,00	363	16123620OP	30,00	415				19017401NM	310,00	284
13463910	11,00	490	13495102KMB	1.349,00	363	16123620OPM	30,00	415				19017402	260,00	284
134714	520,00	364	13495102NM	1.349,00	363	16123620OR	30,00	415				19017402AC	403,00	284
134715	520,00	366	13495102OM	1.740,00	363	161445	316,00	468				19017402BM	403,00	284
134738	54,00	380	13495102OP	1.740,00	363	161445	316,00	437				19017402KMB	403,00	284
13473850	19,50	380	13495102OPM	1.740,00	363	161446	366,00	468				19017402NM	403,00	284
13474010	19,50	493	13495102OR	1.740,00	363	161446	366,00	437				19017402OM	520,00	284
13474020	8,80	493	134951AC	1.542,00	363	161475	245,00	400				19017402OPM	520,00	284
13474110	23,00	469	134951BM	1.542,00	363	161476	299,00	401				19017403	260,00	283
13474110AC	35,65	469	134951NM	1.542,00	363	161835	37,20	392				19017403AC	403,00	283
13474110BM	35,65	469	134951OM	1.990,00	363	161838	57,30	393				19017403BM	403,00	283
13474110NM	35,65	469	134951OR	1.990,00	363	161839	27,50	404				19017403KMB	403,00	283
13474110OM	46,00	469	13499501	1.495,00	479	161840	42,00	485				19017403NM	403,00	283
13474210	12,00	498	13499502	1.595,00	479	162161	812,00	352				19017403OM	520,00	283
13474220	15,30	498	13499503	995,00	480	162161	812,00	143				19017403OPM	520,00	283
13474310	16,80	489	13499504	1.695,00	479	16216150	300,00	501				19017404	260,00	283
13474320	16,60	489	139441	82,50	451	162245	395,00	353				19017404AC	403,00	283
13474330	16,60	489				162245	395,00	143				19017404BM	403,00	283
134748	47,00	385				162245	395,00	67				19017404KMB	403,00	283
134757	22,30	407	143835	23,80	392	16235590	60,00	459				19017404NM	403,00	283
134808	37,70	380	143836	60,80	396	162435	260,00	445				19017404OM	520,00	283
134818	85,00	379				162436	225,00	446				19017404OPM	520,00	283
134835	62,00	393				162437	260,00	460				19017405	260,00	283
134846	105,00	492				162438	265,00	460				19017405AC	403,00	283
134870	86,00	500	16110342	165,00	494	162440	195,00	448				19017405BM	403,00	283
134871	99,00	500	16110342AC	256,00	494	162441	198,00	446				19017405KMB	403,00	283
134873	20,00	407	16110342BM	256,00	494	162442	174,00	447				19017405NM	403,00	283
134923	98,30	397	16110342KM	256,00	494	162443	174,00	447				19017405OM	520,00	283
134940	795,00	366	16110342KMB	256,00	494	162453	306,00	459				19017405OPM	520,00	283
13494010	58,00	486	16110342NM	256,00	494	162456	280,00	459				19017405OM	520,00	283
134940AC	1.232,00	366	16110342OM	330,00	494	162540	235,00	447				19017406	310,00	283
134940BM	1.232,00	366	16110342OP	330,00	494	162541	270,00	446				19017406AC	481,00	283
134940KM	1.232,00	366	16110342OPM	330,00	494	162840	33,00	485				19017406BM	481,00	283
134940KMB	1.232,00	366	16110342OR	330,00	494	163333	295,00	462				19017406NM	481,00	283
134940NM	1.232,00	366	16110362	175,00	495	169440	106,00	450				19017406OM	620,00	283
134940OM	1.232,00	366	16110372	82,00	495							19019601	197,00	287
134940OP	1.590,00	366	16117002	99,00	502							19031202	603,00	289
134940OPM	1.590,00	366	16117102	111,00	503	17021802	94,00	456				19031202AC	935,00	289
134940OR	1.590,00	366	16118740	75,00	378	17031802	99,00	456				19031202BM	935,00	289
13494110	60,00	486	16118740AC	116,00	378	17032002	100,00	454				19031202KMB	935,00	289
134944	795,00	364	16118740BM	116,00	378	17033202	115,00	456				19031202NM	935,00	289
134944AC	1.232,00	364	16118740KMB	116,00	378	17033302	82,00	452				19031202OM	1.206,00	289
134944BM	1.232,00	364	16118740NM	116,00	378	17041802	98,00	454				19031202OPM	1.206,00	289
134944NM	1.232,00	364	16118740OM	150,00	378	17044002	105,00	452				19031205	635,00	289
134944OM	1.590,00	364	16118740OP	150,00	378	17044102	72,50	451				19031205AC	984,00	289
134944OP	1.590,00	364	16118740OPM	150,00	378	17044702	98,50	449				19031205BM	984,00	289
134944OR	1.590,00	364	16118740OR	150,00	378	172218	105,00	456				19031205KMB	984,00	289
134950	995,00	365	161194	300,00	499	172317	105,00	454				19031205NM	984,00	289
13495001	750,00	365	161213	326,00	403	172318	115,00	454				19031205OM	1.270,00	289
13495001AC	1.163,00	365	161214	300,00	402	17231811	190,00	477				19031205OPM	1.270,00	289
13495001BM	1.163,00	365	16123601	60,00	415	172333	80,00	452				19031205OPM	1.206,00	289
13495001KM	1.163,00	365	16123601AC	93,00	415	17233311	147,00	478				19031205AC	984,00	289
13495001KMB	1.163,00	365	16123601BM	93,00	415	172418	95,00	455				19031205BM	984,00	289
13495001NM	1.163,00	365	16123601KM	93,00	415	172420	115,00	455				19031205KMB	984,00	289
13495001OM	1.500,00	365	16123601KMB	93,00	415	172440	110,00	451				19031205NM	984,00	289
13495001OP	1.500,00	365	16123601NM	93,00	415	172447	98,50	449				19031205OM	1.270,00	289
13495001OPM	1.500,00	365	16123601OM											

REFERENCIA	€	Pág.	REFERENCIA	€	Pág.	REFERENCIA	€	Pág.	REFERENCIA	€	Pág.	REFERENCIA	€	Pág.
19038702	592,00	158	19039307BM	927,00	128	20016201AC	620,00	103	20020303OM	464,00	96	20024501	395,00	127
19038702	592,00	144	19039307KMB	927,00	286	20016201BM	620,00	350	20020303OR	464,00	96	20030001	235,00	98
19038702	592,00	285	19039307KMB	927,00	128	20016201BM	620,00	103	20020304	232,00	95	20030001AC	364,00	98
19038702	592,00	70	19039307NM	927,00	114	20016201NM	620,00	350	20020304AC	360,00	95	20030001BM	364,00	98
19038702AC	918,00	285	19039307NM	927,00	286	20016201NM	620,00	103	20020304BL	360,00	95	20030001NM	364,00	98
19038702AC	918,00	70	19039307NM	927,00	128	20016201OM	800,00	350	20020304BM	360,00	95	20030001OM	470,00	98
19038702BM	918,00	285	19039307OM	1.196,00	286	20016201OM	800,00	103	20020304NE	360,00	95	20030001OR	470,00	98
19038702BM	918,00	70	19039307OM	1.196,00	128	20016201OR	800,00	350	20020304NM	360,00	95	20030002	245,00	99
19038702KMB	918,00	285	19039307OPM	1.196,00	286	20016201OR	800,00	103	20020304OM	464,00	95	20030002AC	380,00	99
19038702KMB	918,00	70	19039307OPM	1.196,00	128	20016203	390,00	350	20020304OR	464,00	95	20030002BM	380,00	99
19038702NM	918,00	285	19063502	345,00	400	20016203	390,00	103	20020305	265,00	96	20030002NM	380,00	99
19038702NM	918,00	70	19063502BM	535,00	400	20016203AC	605,00	350	20020305AC	411,00	96	20030002OM	490,00	99
19038702OM	1.184,00	285	19063502KMB	535,00	400	20016203AC	605,00	103	20020305BL	411,00	96	20030002OR	490,00	99
19038702OM	1.184,00	70	19063502NM	535,00	400	20016203BM	605,00	350	20020305BM	411,00	96	20044001	250,00	445
19038702OPM	1.184,00	285	19063502OM	691,00	400	20016203BM	605,00	103	20020305NE	411,00	96	20044001AC	388,00	445
19038702OPM	1.184,00	70	19063502OPM	691,00	400	20016203NM	605,00	350	20020305NE	411,00	96	20044001BM	388,00	445
19038705	563,00	114	19063504	332,00	399	20016203NM	605,00	103	20020305OM	530,00	96	20044001NE	388,00	445
19038705	563,00	104	19063504AC	514,00	399	20016203OM	780,00	350	20020305OR	530,00	96	20044001NM	388,00	445
19038705	563,00	285	19063504BM	514,00	399	20016203OM	780,00	103	20020306	265,00	95	20044001OM	500,00	445
19038705AC	873,00	114	19063504NM	514,00	399	20016203OR	780,00	350	20020306AC	411,00	95	20044002	225,00	447
19038705AC	873,00	104	19063504OM	663,00	399	20016203OR	780,00	103	20020306BL	411,00	95	20044002AC	349,00	447
19038705AC	873,00	285	19250730	70,00	498	20016701	235,00	100	20020306BM	411,00	95	20044002BM	349,00	447
19038705BM	873,00	114	19250730	70,00	433	20016701AC	364,00	100	20020306NE	411,00	95	20044002NM	349,00	447
19038705BM	873,00	104	19260603	290,00	429	20016701BM	364,00	100	20020306NM	411,00	95	20047501	240,00	402
19038705BM	873,00	285	19290603	330,00	433	20016701NM	364,00	100	20020306OM	530,00	95	20050301	95,00	98
19038705KMB	873,00	285				20016701OM	470,00	100	20020306OR	530,00	95	20050301	95,00	135
19038705NM	873,00	114				20016701OR	470,00	100	20020501	185,00	98	20050301AC	147,00	98
19038705NM	873,00	104	20010101	150,00	96	20017001	255,00	100	20020501AC	287,00	98	20050301BM	147,00	98
19038705NM	873,00	285	20010101D	172,00	96	20017001AC	395,00	100	20020501BL	287,00	98	20050301NM	147,00	98
19038705OM	1.126,00	104	20010102	150,00	95	20017001BM	395,00	100	20020501BL	287,00	98	20050301OM	190,00	98
19038705OM	1.126,00	285	20010102B	172,00	95	20017001NM	395,00	100	20020501NE	287,00	98	20050301OR	190,00	98
19038705OPM	1.126,00	285	20010102D	172,00	95	20017001OM	510,00	100	20020501NE	287,00	98	20210301	184,00	43
19039301	411,00	190	20010301	125,00	96	20017001OM	510,00	100	20020501NM	287,00	98	20210301AC	285,00	43
19039301	411,00	200	20010301AC	194,00	96	20017001OR	510,00	100	20020501OM	370,00	98	20210301D	285,00	43
19039301	411,00	286	20010301BL	194,00	96	20017701	110,00	324	20020501OR	370,00	98	20210301BM	285,00	43
19039301NM	637,00	286	20010301BM	194,00	96	20017701	110,00	101	20020502	205,00	98	20210301D	206,00	43
19039302	563,00	177	20010301D	147,00	96	20018001	170,00	326	20020502AC	318,00	98	20210301NM	285,00	43
19039302	563,00	158	20010301NE	194,00	96	20018001	170,00	101	20020502BL	318,00	98	20210301OM	368,00	43
19039302	563,00	144	20010301NM	194,00	96	20018001AC	264,00	326	20020502BM	318,00	98	20210301OR	368,00	43
19039302	563,00	286	20010301OM	250,00	96	20018001AC	264,00	101	20020502NE	318,00	98	20210302	184,00	43
19039302AC	873,00	286	20010301OR	250,00	96	20018001BM	264,00	326	20020502NE	318,00	98	20210302D	206,00	43
19039302BM	873,00	286	20010302	125,00	95	20018001BM	264,00	101	20020502NM	410,00	98	20210303	345,00	43
19039302KMB	873,00	286	20010302AC	194,00	95	20018001NM	264,00	326	20020502OR	410,00	98	20210303AC	535,00	43
19039302NM	873,00	286	20010302BL	194,00	95	20018001NM	264,00	101	20020503	225,00	98	20210303BM	535,00	43
19039302OM	1.126,00	286	20010302BM	194,00	95	20018001OM	340,00	326	20020503AC	349,00	98	20210303NM	535,00	43
19039302OPM	1.126,00	286	20010302D	147,00	95	20018001OM	340,00	101	20020503BL	349,00	98	20210303OM	690,00	43
19039305	595,00	168	20010302NE	194,00	95	20018001OR	340,00	326	20020503BM	349,00	98	20210303OR	690,00	43
19039305	595,00	285	20010302NM	194,00	95	20018001OR	340,00	101	20020503NE	349,00	98	20210304	345,00	43
19039305	595,00	128	20010302OM	250,00	95	20018002	482,00	329	20020503NM	349,00	98	20210305	380,00	44
19039305AC	922,00	285	20010302OR	250,00	95	20018002	482,00	102	20020503OM	450,00	98	20210305AC	589,00	44
19039305AC	922,00	128	20011001	212,00	97	20018005	750,00	331	20020503OR	450,00	98	20210305BM	589,00	44
19039305BM	922,00	285	20011001BL	329,00	97	20018005	750,00	103	20020504	200,00	97	20210305NM	589,00	44
19039305BM	922,00	128	20011001NE	329,00	97	20018005AC	1.163,00	331	20020504AC	310,00	97	20210305OM	760,00	44
19039305KMB	922,00	285	20011002	212,00	96	20018005AC	1.163,00	103	20020504BL	310,00	97	20210305OR	760,00	44
19039305KMB	922,00	128	20011002BL	329,00	96	20018005BM	1.163,00	331	20020504BM	310,00	97	20210306	380,00	43
19039305NM	922,00	285	20011002NE	329,00	96	20018005BM	1.163,00	103	20020504NE	310,00	97	20210501	370,00	44
19039305NM	922,00	128	20012001	128,00	99	20018005NM	1.163,00	331	20020504NM	310,00	97	20210501AC	574,00	44
19039305OM	1.190,00	285	20012001AC	198,00	99	20018005NM	1.163,00	103	20020504OM	400,00	97	20210501BM	574,00	44
19039305OM	1.190,00	128	20012001BL	198,00	99	20018005OM	1.500,00	331	20020504OR	400,00	97	20210501NM	574,00	44
19039305OPM	1.190,00	285	20012001BM	198,00	99	20018005OM	1.500,00	103	20020505	210,00	97	20210501OM	740,00	44
19039305OPM	1.190,00	128	20012001D	150,00	99	20018005OR	1.500,00	331	20020505AC	326,00	97	20210501OR	740,00	44
19039306	691,00	89	20012001NE	198,00	99	20018005OR	1.500,00	103	20020505BL	326,00	97	20212001	187,00	46
19039306	691,00	284	20012001NM	198,00	99	20018009	422,00	332	20020505BM	326,00	97	20212001AC	290,00	46
19039306	691,00	51	20012001OM	256,00	99	20018009	422,00	102	20020505NE	326,00	97	20212001BM	290,00	46
19039306AC	1.071,00	89	20012001OR	256,00	99	20018010	95,50	326	20020505NM	326,00	97	20212001D	209,00	46
19039306AC	1.071,00	284	20012002	128,00	99	20018010	95,50	101	20020505OM	420,00	97	20212001NM	290,00	46
19039306BM	1.071,00	51	20012002AC	198,00	99	20018010OM	191,00	326	20020505OR	420,00	97	20212001OM	374,00	46
19039306BM	1.071,00	89	20012002BL	198,00	99	20018010OM	191,00	101	20020506	220,00	97	20212001OR	374,00	46
19039306BM	1.071,00	284	20012002BM	198,00	99	20018010OR	191,00	326	20020506AC	341,00	97	20212002	187,00	46
19039306BM	1.071,00	51	20012002D	150,00	99	20018010OR	191,00	101	20020506BL	341,00	97	20212002D	209,00	46
19039306NM	1.071,00	89	20012002NE	198,00	99	20018011	456,00	328	20020506BM	341,00	97	20216101	500,00	348
19039306NM	1.071,00	284	20012002NM	198,00	99	20018011	456,00	101	20020506NE	341,00	97	20216101	500,00	50
19039306NM	1.071,00	51	20012002OM	256,00	99	20018080	449,00	332	20020506NM	341,00	97	20216101AC	775,00	348
19039306OM	1.382,00	89	20012											

REFERENCIA	€	Pág.	REFERENCIA	€	Pág.	REFERENCIA	€	Pág.	REFERENCIA	€	Pág.	REFERENCIA	€	Pág.
20216103BM	760,00	50	202278100M	170,00	48	20230002OR	530,00	46	20322401	163,00	151	20528006	319,00	166
20216103NM	760,00	348	202278100R	170,00	302	20230003	270,00	46	20324501	395,00	353	20528006	319,00	320
20216103OM	980,00	348	202278100R	170,00	48	20230003AC	419,00	46	20324501	395,00	157	20528110	95,00	165
20216103OR	980,00	50	20228003	624,00	313	20230003BM	419,00	46	20324501	395,00	103	20528110	95,00	307
20216701	328,00	47	20228003	624,00	49	20230003NM	419,00	46	20324501	395,00	143	20530001	210,00	163
20216701AC	508,00	47	20228003AC	967,00	313	20230003OR	540,00	46	20340301	170,00	150	20530002	220,00	163
20216701BM	508,00	47	20228003BM	967,00	313	20230004	280,00	46	20370301	160,00	150	20530001	220,00	163
20216701NM	508,00	47	20228003NM	967,00	313	20230004AC	434,00	46	20410301	87,00	173	20530002	230,00	163
20216701OM	656,00	47	20228003NM	967,00	49	20230004BM	434,00	46	20410301D	109,00	173	20544001	220,00	446
20217001	348,00	47	20228003OM	1.248,00	313	20230004NM	434,00	46	20412001	90,00	173	20544001AC	341,00	446
20217001AC	539,00	47	20228003OR	1.248,00	49	20230004OM	560,00	46	20412001D	112,00	173	20544001BM	341,00	446
20217001BM	539,00	47	20228003OR	1.248,00	313	20230004OR	560,00	46	20416701	125,00	174	20544001NM	341,00	446
20217001NM	539,00	47	20228004	599,00	309	20230001	290,00	45	20417001	145,00	174	20544001OM	440,00	446
20217001OM	696,00	47	20228004AC	928,00	309	202300011	450,00	45	20417701	92,00	325	20548601	245,00	445
20217001OR	696,00	47	20228004AC	928,00	48	202300011AC	450,00	45	20417701	92,00	176	20548601AC	380,00	445
20218201	63,00	406	20228004BM	928,00	309	202300011BM	450,00	45	20418001	132,00	327	20548601BM	380,00	445
20218201AC	97,65	406	20228004BM	928,00	48	202300011NM	450,00	45	20418001	132,00	176	20548601NM	380,00	445
20218201BM	97,65	406	20228004NM	928,00	309	202300011OM	580,00	45	20418002	369,00	331	20548601OM	490,00	445
20218201NM	97,65	406	20228004NM	928,00	48	202300011OR	580,00	45	20418002	369,00	177	20548702	425,00	457
20218201OM	126,00	406	20228004OM	1.198,00	309	202300012	300,00	45	20418005	356,00	334	20548702AC	659,00	457
20218201OR	126,00	406	20228004OR	1.198,00	48	202300012AC	465,00	45	20418005	356,00	177	20548702BM	659,00	457
20219101	720,00	338	20228005	743,00	312	202300012BM	465,00	45	20425001	85,00	258	20548702NM	659,00	457
20219101AC	1.116,00	338	20228005	743,00	49	202300012NM	465,00	45	20425003	439,00	169	20560301	295,00	429
20219101BM	1.116,00	338	20228005AC	1.152,00	312	202300012OM	600,00	45	20425003	439,00	178	20560302	335,00	432
20219101NM	1.116,00	338	20228005AC	1.152,00	49	202300012OR	600,00	45	20425003	439,00	265	20718107	155,00	502
20219101OM	1.116,00	338	20228005BM	1.152,00	312	202300013	305,00	45	20425004	465,00	169	20718107AC	240,00	502
20219101OR	1.116,00	338	20228005NM	1.152,00	312	202300013AC	473,00	45	20425004	465,00	178	20718107BM	240,00	502
20224501	395,00	50	20228005OR	1.152,00	49	202300013BM	473,00	45	20425004	465,00	261	20718107NM	240,00	502
20224501	395,00	50	20228005OM	1.486,00	49	202300013NM	473,00	45	20425005	792,00	267	20718107OM	310,00	502
20225053	684,00	263	20228005OR	1.486,00	49	202300013OM	610,00	45	20425006	393,00	270	20718107OR	310,00	502
20225053AC	1.060,00	263	20228005OR	1.486,00	49	202300013OR	610,00	45	20427810	60,00	174	20718201	70,00	293
20225053BM	1.060,00	263	20228006	1.080,00	316	202300014	315,00	45	20427810	60,00	304	20718201	70,00	405
20225053NM	1.060,00	263	20228006AC	1.674,00	316	202300014AC	488,00	45	20428003	338,00	175	20718201	70,00	421
20225053OM	1.060,00	263	20228006BM	1.674,00	316	202300014BM	488,00	45	20428003	338,00	316	20718201	70,00	233
20225053OR	1.060,00	263	20228006NM	1.674,00	316	202300014NM	488,00	45	20428004	357,00	175	20718201AC	109,00	293
20225054	659,00	259	20228006OM	2.160,00	316	202300014OM	630,00	45	20428004	357,00	312	20718201AC	109,00	405
20225054AC	1.021,00	259	20228006OR	2.160,00	316	202300014OR	630,00	45	20428005	599,00	175	20718201AC	109,00	421
20225054BM	1.021,00	259	20228007	472,00	319	20261310	340,00	429	20428005	599,00	318	20718201AC	109,00	233
20225054NM	1.021,00	259	20228007AC	732,00	319	20261310AC	340,00	44	20428006	304,00	176	20718201BM	109,00	293
20225054OM	1.318,00	259	20228007BM	732,00	319	20261310AC	527,00	429	20428006	304,00	321	20718201BM	109,00	405
20225054OR	1.318,00	259	20228007NM	732,00	50	20261310AC	527,00	44	20428110	75,00	174	20718201BM	109,00	421
20225055	803,00	262	20228007OM	944,00	319	20261310BM	527,00	429	20428110	75,00	308	20718201BM	109,00	233
20225055AC	1.245,00	262	20228007OR	944,00	50	20261310BM	527,00	44	20430001	200,00	173	20718201NM	109,00	293
20225055BM	1.245,00	262	20228110	110,00	305	20261310NM	527,00	429	20430002	210,00	173	20718201NM	109,00	405
20225055NM	1.245,00	262	20228110AC	171,00	305	20261310NM	527,00	44	20510301	102,00	163	20718201NM	109,00	421
20225055OM	1.606,00	262	20228110AC	171,00	48	20261310OM	680,00	429	20510301D	124,00	163	20718201NM	109,00	233
20225055OR	1.606,00	262	20228110AC	171,00	305	20261310OM	680,00	44	20510303	200,00	163	20718201OM	140,00	293
20225056	1.140,00	268	20228110BM	171,00	48	20261310OR	680,00	429	20511201	113,00	472	20718201OM	140,00	405
20225056AC	1.767,00	268	20228110BM	171,00	305	20261310OR	680,00	44	20511202	153,00	472	20718201OM	140,00	421
20225056BM	1.767,00	268	20228110NM	171,00	48	20261320	380,00	432	20512001	105,00	164	20718201OM	140,00	233
20225056NM	1.767,00	268	20228110NM	171,00	305	20261320	380,00	44	20512001D	127,00	164	20718201OPM	140,00	421
20225056OM	2.280,00	268	20228110NM	171,00	48	20261320AC	589,00	432	20516101	360,00	351	20718201OPM	140,00	233
20225056OR	2.280,00	268	20228110OM	220,00	305	20261320AC	589,00	44	20516103	350,00	351	20718201OR	140,00	293
20225057	532,00	270	20228110OM	220,00	48	20261320BM	589,00	432	20516103	350,00	168	20718201OR	140,00	405
20225057AC	825,00	270	20228110OR	220,00	305	20261320BM	589,00	44	20516103	350,00	168	20718201OR	140,00	421
20225057BM	825,00	270	20228110OR	220,00	48	20261320NM	589,00	432	20516701	130,00	164	20718201OR	140,00	233
20225057NM	825,00	270	20228110OR	220,00	305	20261320NM	589,00	44	20517001	150,00	164	20725001	155,00	507
20225057OM	1.064,00	270	20228110OR	220,00	48	20261320OM	760,00	432	20517701	92,00	166	20785001	130,00	19
20225057OR	1.064,00	270	20228110OR	220,00	305	20261320OM	760,00	44	20517701	92,00	324	20785001	130,00	256
20227810	85,00	302	20228110OR	220,00	48	20261320OR	760,00	432	20518001	132,00	166	20827810	80,00	208
20227810AC	132,00	302	20228110OR	220,00	305	20263901	48,00	381	20518001	132,00	326	20827810	80,00	217
20227810AC	132,00	48	20228110OR	220,00	48	20263901AC	74,40	381	20518002	405,00	167	20827810	80,00	188
20227810BM	132,00	302	20228110OR	220,00	305	20263901BM	74,40	381	20518002	405,00	329	20827810	80,00	198
20227810BM	132,00	48	20228110OR	220,00	48	20263901KM	74,40	381	20518006	410,00	167	20827810	80,00	164
20227810NM	132,00	302	20228110OR	220,00	305	20263901KMB	74,40	381	20518006	410,00	329	20827810	80,00	83
20227810NM	132,00	48	20228110OR	220,00	48	20263901NM	74,40	381	20518007	384,00	167	20827810	80,00	174
20227810OM	132,00	302	20228110OR	220,00	305	20263901NM	74,40	381	20518007	384,00	333	20827810	80,00	113
20227810OM	132,00	48	20228110OR	220,00	48	20263901OM	96,00	381	20518007	384,00	407	20827810	80,00	139
20227810OR	132,00	302	20228110OR	220,00	305	20263901OP	96,00	381	20518301	33,50	407	20827810	80,00	124
20227810OR	132,00	48	20228110OR	220,00	48	20263901OPM	96,00	381	20522201	220,00	100	20827810	80,00	124
20227810OR	132,00	302	20228110OR	220,00	305	20263901OPM	96,00	381	20522201AC	341,00	100	20827810	80,00	302
20227810OR	132,00	48	20228110OR	220,00	48	20263901OR	96,00	381	20522201BM	341,00	100	20827810	80,00	48
20227810OR	132,00	302	20228110OR	220,00	305	20310301	84,00	149						

REFERENCIA	€	Pág.	REFERENCIA	€	Pág.	REFERENCIA	€	Pág.	REFERENCIA	€	Pág.	REFERENCIA	€	Pág.
21			21112002KM	169,00	123	21120301OR	444,00	120	21125005OP	1.546,00	262	21128005	718,00	313
21018107	99,00	502	21112002KMB	169,00	123	21120302	222,00	119	21125005OPM	1.546,00	129	21128005AC	1.113,00	126
21018107AC	153,00	502	21112002NM	169,00	123	21120302AC	344,00	119	21125006OPM	1.546,00	262	21128005AC	1.113,00	313
21018107BM	153,00	502	21112002OM	218,00	123	21120302BM	344,00	119	21125005OR	1.546,00	129	21128005BM	1.113,00	126
21018107KM	153,00	502	21112002OP	218,00	123	21120302KM	344,00	119	21125005OR	1.546,00	262	21128005BM	1.113,00	313
21018107KMB	153,00	502	21112002OPM	218,00	123	21120302KMB	344,00	119	21125006	1.110,00	266	21128005KM	1.113,00	126
21018107NM	153,00	502	21112002OR	218,00	123	21120302NM	344,00	119	21125006AC	1.721,00	266	21128005KM	1.113,00	313
21018107OM	198,00	502	21116101	370,00	350	21120302OM	444,00	119	21125006BM	1.721,00	266	21128005KMB	1.113,00	126
21018107OP	198,00	502	21116101	370,00	127	21120302OP	444,00	119	21125006KMB	1.721,00	266	21128005KMB	1.113,00	313
21018107OPM	198,00	502	21116101AC	574,00	350	21120302OPM	444,00	119	21125006NM	1.721,00	266	21128005NM	1.113,00	126
21018107OR	198,00	502	21116101AC	574,00	127	21120302OR	444,00	119	21125006OM	2.220,00	266	21128005NM	1.113,00	313
21027301	1.141,00	293	21116101BM	574,00	350	21120501	175,00	121	21125006OP	2.220,00	266	21128005OM	1.436,00	126
21027301AC	1.769,00	293	21116101BM	574,00	127	21120501AC	271,00	121	21125006OPM	2.220,00	266	21128005OM	1.436,00	313
21027301BM	1.769,00	293	21116101KM	574,00	350	21120501BM	271,00	121	21125006OR	2.220,00	266	21128005OP	1.436,00	126
21027301NM	1.769,00	293	21116101KM	574,00	127	21120501KMB	271,00	121	21125007	449,00	270	21128005OPM	1.436,00	313
21027301OM	2.282,00	293	21116101KMB	574,00	350	21120501NM	271,00	121	21125007AC	696,00	270	21128005OPM	1.436,00	126
21027301OR	2.282,00	293	21116101NM	574,00	350	21120501OM	350,00	121	21125007BM	696,00	270	21128005OR	1.436,00	126
21027303	1.825,00	294	21116101NM	574,00	127	21120501OP	350,00	121	21125007KM	696,00	270	21128005OR	1.436,00	313
21027303AC	2.829,00	294	21116101OM	740,00	350	21120501OPM	350,00	121	21125007KMB	696,00	270	21128006	1.055,00	126
21027303BM	2.829,00	294	21116101OM	740,00	127	21120501OR	350,00	121	21125007NM	696,00	270	21128006	1.055,00	317
21027303NM	2.829,00	294	21116101OP	740,00	350	21122401	190,00	123	21125007OP	898,00	270	21128006AC	1.635,00	126
21027303OM	3.650,00	294	21116101OP	740,00	127	21122401AC	295,00	123	21125007PM	898,00	270	21128006AC	1.635,00	317
21027303OR	3.650,00	294	21116101OPM	740,00	350	21122401BM	295,00	123	21125007PM	898,00	270	21128006BM	1.635,00	126
21027304	1.133,00	294	21116101OPM	740,00	127	21122401KMB	295,00	123	21125007OR	898,00	270	21128006BM	1.635,00	317
21027305	1.231,00	294	21116101OR	740,00	350	21122401NM	295,00	123	21127810	75,00	124	21128006KM	1.635,00	126
21027309	1.550,00	295	21116103	380,00	351	21122401OM	380,00	123	21127810AC	116,00	124	21128006KMB	1.635,00	126
21027310	1.251,00	295	21116103	380,00	127	21122401OP	380,00	123	21127810AC	116,00	303	21128006KMB	1.635,00	317
21027311	1.279,00	295	21116103AC	589,00	351	21122401OPM	380,00	123	21127810BM	116,00	124	21128006NM	1.635,00	126
21027311AC	1.982,00	295	21116103AC	589,00	127	21122401OR	380,00	123	21127810BM	116,00	303	21128006NM	1.635,00	317
21027311BM	1.982,00	295	21116103BM	589,00	351	21125001	110,00	257	21127810KM	116,00	124	21128006OM	2.110,00	126
21027311NM	1.982,00	295	21116103BM	589,00	127	21125001AC	171,00	257	21127810KM	116,00	303	21128006OM	2.110,00	317
21027312	931,00	296	21116103KM	589,00	351	21125001BM	171,00	257	21127810KMB	116,00	124	21128006OP	2.110,00	126
21027313	862,00	296	21116103KM	589,00	127	21125001KMB	171,00	257	21127810KMB	116,00	303	21128006OP	2.110,00	317
21027313AC	1.336,00	296	21116103KMB	589,00	351	21125001NM	171,00	257	21127810NM	116,00	124	21128006OPM	2.110,00	126
21027313BM	1.336,00	296	21116103KMB	589,00	127	21125001NM	171,00	257	21127810NM	116,00	303	21128006OPM	2.110,00	317
21027313NM	1.336,00	296	21116103NM	589,00	351	21125001OM	220,00	257	21127810OM	150,00	124	21128006OPM	2.110,00	126
21027391	528,00	293	21116103NM	589,00	127	21125001OP	220,00	257	21127810OM	150,00	303	21128006OR	2.110,00	126
21027391AC	818,00	293	21116103NM	589,00	351	21125001OPM	220,00	257	21127810OP	150,00	124	21128006OR	2.110,00	317
21027391BM	818,00	293	21116103OM	760,00	351	21125001OR	220,00	257	21127810OPM	150,00	124	21128007	394,00	126
21027391NM	818,00	293	21116103OP	760,00	127	21125003	559,00	128	21127810OP	150,00	303	21128007	394,00	320
21027391OM	1.056,00	293	21116103OP	760,00	351	21125003AC	866,00	128	21127810OPM	150,00	124	21128007AC	611,00	126
21027391OR	1.056,00	293	21116103OPM	760,00	127	21125003AC	866,00	264	21127810OPM	150,00	303	21128007AC	611,00	320
21027399	395,00	293	21116103OPM	760,00	351	21125003AC	866,00	128	21127810OR	150,00	124	21128007BM	611,00	126
21027399AC	612,00	293	21116103OR	760,00	127	21125003AC	866,00	264	21128003	504,00	125	21128007BM	611,00	320
21027399BM	612,00	293	21116103OR	760,00	351	21125003BM	866,00	128	21128003	504,00	314	21128007KM	611,00	126
21027399NM	612,00	293	21116103OR	760,00	127	21125003BM	866,00	264	21128003AC	781,00	125	21128007KM	611,00	320
21027399OM	790,00	293	21116701	220,00	124	21125003KM	866,00	128	21128003AC	781,00	314	21128007KMB	611,00	126
21027399OR	790,00	293	21116701AC	341,00	124	21125003KMB	866,00	264	21128003AC	781,00	314	21128007KMB	611,00	320
21110301	106,00	119	21116701BM	341,00	124	21125003KMB	866,00	128	21128003BM	781,00	125	21128007NM	611,00	126
21110301AC	164,00	119	21116701KM	341,00	124	21125003KMB	866,00	264	21128003BM	781,00	314	21128007NM	611,00	320
21110301BM	164,00	119	21116701KMB	341,00	124	21125003NM	866,00	128	21128003KM	781,00	125	21128007OM	788,00	126
21110301D	128,00	119	21116701NM	341,00	124	21125003NM	866,00	264	21128003KM	781,00	314	21128007OM	788,00	320
21110301KM	164,00	119	21116701OM	440,00	124	21125003OM	1.118,00	128	21128003KMB	781,00	125	21128007OP	788,00	126
21110301KMB	164,00	119	21116701OP	440,00	124	21125003OM	1.118,00	264	21128003KMB	781,00	314	21128007OP	788,00	320
21110301NM	164,00	119	21116701OPM	440,00	124	21125003OP	1.118,00	128	21128003NM	781,00	125	21128007OPM	788,00	126
21110301OM	212,00	119	21116701OR	440,00	124	21125003OP	1.118,00	264	21128003NM	781,00	314	21128007OPM	788,00	320
21110301OP	212,00	119	21117001	240,00	124	21125003OPM	1.118,00	128	21128003OP	1.008,00	125	21128007OR	788,00	126
21110301OPM	212,00	119	21117001AC	372,00	124	21125003OPM	1.118,00	264	21128003OP	1.008,00	314	21128007OR	788,00	320
21110301OR	212,00	119	21117001BM	372,00	124	21125003OR	1.118,00	128	21128003OPM	1.008,00	125	21128110	95,00	125
21110302	106,00	119	21117001KM	372,00	124	21125003OR	1.118,00	264	21128003OPM	1.008,00	314	21128110	95,00	306
21110302AC	164,00	119	21117001KMB	372,00	124	21125004	592,00	260	21128003OPM	1.008,00	125	21128110AC	147,00	125
21110302BM	164,00	119	21117001NM	372,00	124	21125004AC	918,00	260	21128003OPM	1.008,00	314	21128110AC	147,00	306
21110302D	128,00	119	21117001OM	480,00	124	21125004BM	918,00	260	21128003OR	1.008,00	125	21128110BM	147,00	125
21110302KM	164,00	119	21117001OP	480,00	124	21125004KM	918,00	260	21128003OR	1.008,00	314	21128110BM	147,00	306
21110302KMB	164,00	119	21117001OPM	480,00										

REFERENCIA	€	Pág.	REFERENCIA	€	Pág.	REFERENCIA	€	Pág.	REFERENCIA	€	Pág.	REFERENCIA	€	Pág.
21130001OP	450,00	122	21190401KM	307,00	120	21619601	244,00	288	21828003	341,00	315	24212101OR	540,00	26
21130001OPM	450,00	122	21190401KMB	307,00	120	21619601NM	378,00	210	21828004	369,00	188	24212201	177,00	26
21130001OR	450,00	122	21190401NM	307,00	120	21619601NM	378,00	288	21828004	369,00	311	24212201AC	274,00	26
21130002	235,00	123	21190401OM	396,00	120	21625001	80,00	258	21828005	589,00	189	24212201LM	248,00	26
21130002AC	364,00	123	21190401OP	396,00	120	21625001NM	124,00	258	21828005	589,00	318	24212201LV	248,00	26
21130002BM	364,00	123	21190401OPM	396,00	120	21625004	405,00	211	21828006	340,00	189	24212201OR	354,00	26
21130002KM	364,00	123	21190401OR	396,00	120	21625004	405,00	261	21828006	340,00	321	24212202	275,00	26
21130002KMB	364,00	123	21190501	208,00	120	21626710	75,00	206	21828110	75,00	188	24212202AC	426,00	26
21130002NM	364,00	123	21190501AC	322,00	120	21627010	95,00	206	21828110	75,00	307	24212202LM	385,00	26
21130002OM	470,00	123	21190501BM	322,00	120	21627810	55,00	208	21830003	190,00	184	24212202LV	385,00	26
21130002OP	470,00	123	21190501KM	322,00	120	21627810	55,00	305	21830004	200,00	184	24212202OR	550,00	26
21130002OPM	470,00	123	21190501KMB	322,00	120	21628004	334,00	208	21830010	44,80	501	24214501	445,00	32
21130002OR	470,00	123	21190501NM	322,00	120	21628004	334,00	312	21830801	140,00	184	24214501AC	690,00	32
21130011	260,00	122	21190501OM	416,00	120	21628110	70,00	208	21830802	130,00	184	24214501LM	623,00	32
21130011AC	403,00	122	21190501OP	416,00	120	21628110	70,00	308	21831221	431,00	187	24214501LV	623,00	32
21130011BM	403,00	122	21190501OPM	416,00	120	21631221	439,00	207	21831221	431,00	344	24214501OR	890,00	32
21130011KM	403,00	122	21190501OR	416,00	120	21631221	439,00	345	21880301	175,00	184	24214601	560,00	32
21130011KMB	403,00	122	21190601	218,00	121	2163200311	156,00	477	21899501	268,00	186	24214601AC	868,00	32
21130011NM	403,00	122	21190601AC	338,00	121	21632010	80,00	455	21899501	268,00	343	24214601LM	784,00	32
21130011OM	520,00	122	21190601BM	338,00	121	21632020	82,00	455				24214601LV	784,00	32
21130011OP	520,00	122	21190601KM	338,00	121	21632030	84,00	455				24214601OR	1.120,00	32
21130011OPM	520,00	122	21190601KMB	338,00	121	21639301	336,00	210	23444005	5,00	524	24214602	555,00	32
21130011OR	520,00	122	21190601NM	338,00	121	21639302NM	520,00	210	23461013	5,00	524	24214602AC	860,00	32
21130012	270,00	122	21190601OM	436,00	121	21639502NM	651,00	211	23461015	5,00	524	24214602LM	777,00	32
21130012AC	419,00	122	21190601OP	436,00	121	21639521	436,00	211	23461038	5,00	525	24214602LV	777,00	32
21130012BM	419,00	122	21190601OPM	436,00	121	21642010	85,00	456	23461050	5,00	524	24214602OR	1.110,00	32
21130012KM	419,00	122	21190601OR	436,00	121	21644010	79,00	450	23461301	5,00	524	24215101	270,00	25
21130012KMB	419,00	122	21210001	42,50	473	21644020	85,00	450	23461303	5,00	524	24215101AC	419,00	25
21130012NM	419,00	122	21210301	58,50	472	21644710	74,50	449	23461305	7,00	524	24215101LM	378,00	25
21130012OM	540,00	122	21220001	38,00	474	21644720	80,50	449	23461380	5,00	524	24215101LV	378,00	25
21130012OP	540,00	122	21510303	51,00	215	21710301	77,00	195	23461501	5,00	524	24215101OR	540,00	25
21130012OPM	540,00	122	21510303D	61,00	215	21710303	75,00	195	23466001	5,00	524	24215102	290,00	25
21130012OR	540,00	122	21510310	54,00	215	21710401	83,00	195	23466203	5,00	524	24215102AC	450,00	25
21130501	195,00	121	21510310D	64,00	215	21712001	78,00	196	23466205	5,00	524	24215102LM	406,00	25
21130501AC	302,00	121	21510410	60,00	215	21712301	170,00	185	23466905	5,00	525	24215102LV	406,00	25
21130501BM	302,00	121	21510410D	70,00	216	21712301	170,00	196	23466938	5,00	525	24215102OR	580,00	25
21130501KM	302,00	121	21512010	54,00	216	21716401	140,00	282	23467205	5,00	525	24215501	89,00	39
21130501KMB	302,00	121	21512010D	64,00	216	21716409	185,00	282	23467238	5,00	525	24215501AC	138,00	39
21130501NM	302,00	121	21516710	84,00	216	21716701	100,00	197	23468301	7,50	525	24215501LM	125,00	39
21130501OM	390,00	121	21517010	99,00	217	21717001	120,00	197	23468303	7,50	525	24215501LV	125,00	39
21130501OP	390,00	121	21517701	80,00	218	21717701	92,00	200				24215501OR	178,00	39
21130501OPM	390,00	121	21517701	80,00	325	21717701	92,00	325				24215502	89,00	39
21130501OR	390,00	121	21518001	115,00	218	21718001	132,00	200	24210201	260,00	23	24215502AC	138,00	39
21140501	215,00	121	21518001	115,00	327	21718001	132,00	327	24210201AC	403,00	23	24215502LM	125,00	39
21140501AC	333,00	121	21518201	48,00	406	21719101	293,00	198	24210201LM	364,00	23	24215502LV	125,00	39
21140501BM	333,00	121	21525001	80,00	258	21719101	293,00	344	24210201LV	364,00	23	24215502OR	178,00	39
21140501KM	333,00	121	21525004	455,00	159	21720301	141,00	195	24210201OR	520,00	23	24216301	280,00	27
21140501KMB	333,00	121	21525004	455,00	262	21720303	139,00	195	24210301	205,00	23	24216301AC	434,00	27
21140501NM	333,00	121	21525004NM	705,00	262	21725001	85,00	257	24210301AC	318,00	23	24216301LM	392,00	27
21140501OM	430,00	121	21526710	70,00	216	21725003	391,00	191	24210301LM	287,00	23	24216301LV	392,00	27
21140501OP	430,00	121	21527010	85,00	217	21725003	391,00	201	24210301LV	287,00	23	24216301OR	560,00	27
21140501OPM	430,00	121	21527810	55,00	217	21725003	391,00	265	24210301OR	410,00	23	24216402	641,00	34
21140501OR	430,00	121	21527810	55,00	305	21725004	419,00	191	24210501	365,00	24	24216402AC	994,00	34
21150301	100,00	122	21528110	70,00	217	21725004	419,00	201	24210501AC	566,00	24	24216402LM	897,00	34
21150301AC	155,00	122	21528110	70,00	308	21725004	419,00	261	24210501LM	511,00	24	24216402LV	897,00	34
21150301BM	155,00	122	21530601	26,00	219	21725005	790,00	267	24210501LV	511,00	24	24216409	465,00	33
21150301KM	155,00	122	21533301	62,00	452	21725006	401,00	269	24210501OR	730,00	24	24216409AC	721,00	33
21150301KMB	155,00	122	21544101	68,00	451	21726701	80,00	197	24210601	310,00	24	24216409LM	651,00	33
21150301NM	155,00	122	21550601	30,00	219	21727001	100,00	197	24210601AC	481,00	24	24216409LV	651,00	33
21150301OM	200,00	122	21552001	24,00	219	21727810	60,00	198	24210601LM	434,00	24	24216409OR	930,00	33
21150301OP	200,00	122	21552002	25,50	219	21727810	60,00	304	24210601LV	434,00	24	24216701	290,00	27
21150301OPM	200,00	122	21599002	241,00	218	21728003	341,00	199	24210601OR	620,00	24	24216701AC	450,00	27
21150301OR	200,00	122	21599002	241,00	331	21728003	341,00	315	24210801	240,00	23	24216701LM	406,00	27
21180301	255,00	120	2161030111	92,30	477	21728004	368,00	199	24210801AC	372,00	23	24216701LV	406,00	27
21180301AC	395,00	120	21610303	58,00	205	21728004	368,00	311	24210801LM	336,00	23	24216701OR	580,00	27
21180301BM	395,00	120	21610303NM	89,90	205	21728110	75,00	199	24210801LV	336,00	23	24217001	335,00	27
21180301KM	395,00	120	21610310	60,00	205	21728110	75,00	307	24210801OR	480,00	23	24217001AC	519,00	27
21180301KMB	395,00	120	21610410	66,00	205	21730001	180,00	196	24210901	170,00	23	24217001LM	469,00	27
21180301NM	395,00	120	21612010	61,00	205	21730002	190,00	196	24210901AC	264,00	23	24217001LV	469,00	27
21180301OM	510,00	120	21612010NM	94,55	205	21731221	445,00	198	24210901LM	238,00	23	24217001OR	670,00	27
21180301OP	510,00	120	21616401	135,00	209	21731221	445,00	344	24210901LV	238,00	23	24217301	105,00	24
21180301OPM	510,00	120	21616401NM	209,00	209	21810301	82,00	183	24210901OR	340,00	23	24217301AC	163,00	24
21180301OR	510,00	120	21616409	149,00	209	21810303	80,00	183	24210902	265,00	23	24217301LM	147,00	24
21180302	255,00	119	21616409NM	231,00	209	21810401	88,00	183	24210902AC	411,00	23	24217301LV	147,00	24
21180302AC	395,00	119	21616710											

REFERENCIA	€	Pág.	REFERENCIA	€	Pág.	REFERENCIA	€	Pág.	REFERENCIA	€	Pág.	REFERENCIA	€	Pág.
24217601AC	643,00	27	24220001LM	350,00	24	24273201	210,00	393	26110502OP	480,00	60	26218004NM	153,00	502
24217601LM	581,00	27	24220001LV	350,00	24	24273201AC	326,00	29	26110502OPM	480,00	60	26218004OM	198,00	502
24217601LV	581,00	27	24220001OR	500,00	24	24273201LM	294,00	29	26110502OR	480,00	60	26218004OP	198,00	502
24217601OR	830,00	27	24221501	230,00	463	24273201LV	294,00	393	26112001	168,00	63	26218004OPM	198,00	502
24217602	849,00	28	24221501AC	357,00	463	24273201LM	294,00	393	26112001D	190,00	63	26218004OR	198,00	502
24217602AC	1.316,00	28	24221501LM	322,00	463	24273201LV	294,00	393	26116701	265,00	64	26222402	210,00	63
24217602LM	1.189,00	28	24221501LV	322,00	463	24284001	46,50	484	26116701AC	411,00	64	26222402AC	326,00	63
24217602LV	1.189,00	28	24222001	243,00	26	24284001AC	72,10	484	26116701BM	411,00	64	26222402BM	326,00	63
24217609	650,00	33	24222001AC	377,00	26	24284001AM	72,10	484	26116701KMB	411,00	64	26222402KMB	326,00	63
24217609AC	1.008,00	33	24222001LM	340,00	26	24284001BL	72,10	484	26116701NM	411,00	64	26222402NM	326,00	63
24217609LM	910,00	33	24222001LV	340,00	26	24284001BM	72,10	484	26116701OM	530,00	64	26222402OM	420,00	63
24217609LV	910,00	33	24222001OR	486,00	26	24284001KM	72,10	484	26116701OP	530,00	64	26222402OPM	420,00	63
24217609OR	1.300,00	33	24230601	98,00	25	24284001LM	65,10	484	26116701OPM	530,00	64	26222402OPM	420,00	63
24217701	110,00	30	24230601AC	152,00	25	24284001LV	65,10	484	26116701OR	530,00	64	26222402OR	420,00	63
24217701AC	171,00	30	24230601LM	137,00	25	24284001NE	72,10	484	26116701TAM	411,00	64	26222402TAM	326,00	63
24217701LM	154,00	30	24230601LV	137,00	25	24284001NM	72,10	484	26116701TRO	411,00	64	26222402TRO	326,00	63
24217701LV	154,00	30	24230601OR	196,00	25	24284001OM	93,00	484	26117001	285,00	65	26225001	130,00	256
24217701OR	220,00	30	24231001	225,00	463	24284001OP	93,00	484	26117001AC	442,00	65	26225001AC	202,00	256
24217703	539,00	31	24231001AC	349,00	463	24284001OPM	93,00	484	26117001BM	442,00	65	26225001BM	202,00	256
24217703AC	835,00	31	24231001LM	315,00	463	24284001OR	93,00	484	26117001KM	442,00	65	26225001KM	202,00	256
24217703LM	755,00	31	24231001LV	315,00	463	24284001RO	72,10	484	26117001KMB	442,00	65	26225001KMB	202,00	256
24217703LV	755,00	31	24231001OR	450,00	463	24284002	43,50	484	26117001NM	442,00	65	26225001NM	202,00	256
24218001	170,00	30	24233401	395,00	462	24284002AC	67,45	484	26117001OM	570,00	65	26225001OM	260,00	256
24218001AC	264,00	30	24233401AC	612,00	462	24284002BL	67,45	484	26117001OP	570,00	65	26225001OP	260,00	256
24218001LM	238,00	30	24233401LM	553,00	462	24284002BM	67,45	484	26117001OPM	570,00	65	26225001OPM	260,00	256
24218001LV	238,00	30	24233401LV	553,00	462	24284002KMB	67,45	484	26117001OR	570,00	65	26225001OR	260,00	256
24218001OR	340,00	30	24233401OR	790,00	462	24284002LM	60,90	484	26117001TAM	442,00	65	26225003	546,00	104
24218003	654,00	30	24234101	312,00	448	24284002LV	60,90	484	26117001TRO	442,00	65	26225003	546,00	104
24218003AC	1.014,00	30	24234101AC	484,00	448	24284002NE	67,45	484	26118201	52,00	406	26225003	546,00	104
24218003LM	916,00	30	24234101LM	437,00	448	24284002NM	67,45	484	26118201AC	80,60	406	26225003AC	846,00	104
24218003LV	916,00	30	24234101LV	437,00	448	24284002OM	87,00	484	26118201BM	80,60	406	26225003BM	846,00	104
24218003OR	1.308,00	30	24234101OR	624,00	448	24284002OP	87,00	484	26118201KMB	80,60	406	26225003KMB	846,00	104
24218004	621,00	30	24234201	230,00	462	24284002OPM	87,00	484	26118201NM	80,60	406	26225003NM	846,00	104
24218004AC	963,00	30	24234201AC	357,00	462	24284002OPM	87,00	484	26118201OM	104,00	406	26225003OM	846,00	104
24218004LM	869,00	30	24234201LM	322,00	462	24284002OR	87,00	484	26118201OP	104,00	406	26225003OP	1.092,00	71
24218004LV	869,00	30	24234201LV	322,00	462	24284010	49,50	484	26118201OPM	104,00	406	26225003OPM	1.092,00	71
24218004OR	1.242,00	30	24234201OR	460,00	462	24284020	46,50	484	26118201OR	104,00	406	26225003OPM	1.092,00	71
24218005	409,00	31	24235201	789,00	36	24287101	150,00	35	26130701	297,00	57	26225003OPM	1.092,00	71
24218005AC	634,00	31	24235201AC	1.223,00	36	24287101AC	150,00	499	26130701AC	460,00	57	26225003OPM	1.092,00	71
24218005LM	573,00	31	24235201LM	1.105,00	36	24287101ALM	210,00	35	26130701BM	460,00	57	26225003OPM	1.092,00	71
24218005LV	573,00	31	24235201LV	1.105,00	36	24287101LM	210,00	499	26130701KMB	460,00	57	26225003OPM	1.092,00	71
24218005OR	818,00	31	24235201OR	1.578,00	36	24287101LV	210,00	35	26130701NM	460,00	57	26225003OPM	1.092,00	71
24218006	646,00	31	24235202	1.034,00	36	24287101LM	210,00	499	26130701OM	594,00	57	26225003OPM	1.092,00	71
24218006AC	1.001,00	31	24235202AC	1.603,00	36	24287101LV	210,00	499	26130701OP	594,00	57	26225003OPM	1.092,00	71
24218006LM	904,00	31	24235202LM	1.448,00	36	24287101NM	233,00	499	26130701OPM	594,00	57	26225003OPM	1.092,00	71
24218006LV	904,00	31	24235202LV	1.448,00	36	24287101OR	300,00	35	26130701OR	594,00	57	26225003OPM	1.092,00	71
24218201	68,00	29	24235202OR	2.068,00	36	24287101OR	300,00	499	26130701TAM	460,00	57	26225003OR	1.092,00	71
24218201AC	105,00	29	24235203	1.026,00	36	25477001	11,20	510	26130801	325,00	57	26225003OR	1.092,00	71
24218201LM	95,20	29	24235203AC	1.590,00	36	25477002	9,40	510	26130801AC	504,00	57	26225004	571,00	105
24218201LV	95,20	29	24235203LM	1.436,00	36	25477003	9,90	511	26130801BM	504,00	57	26225004	571,00	105
24218201OR	136,00	29	24235203LV	1.436,00	36	25477004	8,50	510	26130801KMB	504,00	57	26225004	571,00	105
24219101	995,00	28	24235301	1.331,00	37	25477005	12,00	511	26130801NM	504,00	57	26225004	571,00	105
24219101AC	1.542,00	28	24235301AC	2.063,00	37	25477006	1,80	512	26130801OM	650,00	57	26225004	571,00	105
24219101LM	1.393,00	28	24235301LM	1.863,00	37	25477007	12,50	510	26130801OP	650,00	57	26225004	571,00	105
24219101LV	1.393,00	28	24235301LV	1.863,00	37	25477008	4,00	512	26130801OPM	650,00	57	26225004	571,00	105
24219401	437,00	33	24244101	238,00	448	25477009	14,50	511	26130801OPM	650,00	57	26225004	571,00	105
24219401AC	677,00	33	24244101AC	369,00	448	25477010	1,90	512	26130801OR	650,00	57	26225004	571,00	105
24219401LM	612,00	33	24244101LM	333,00	448	25477011	1,85	512	26130801TAM	504,00	57	26225004	571,00	105
24219401LV	612,00	33	24244101LV	333,00	448	25477012	11,50	511	26130801TRO	504,00	57	26225004	571,00	105
24219401OR	874,00	33	24244101OR	476,00	448	25477013	1,55	512	26190301	165,00	57	26225004	571,00	105
24219402	617,00	32	24247601	470,00	29	25477091	33,00	513	26190301AC	256,00	57	26225004	571,00	105
24219402AC	956,00	32	24247601AC	729,00	29	25477092	34,35	513	26190301BM	256,00	57	26225004	571,00	105
24219402LM	864,00	32	24247601LM	658,00	29	26110501	225,00	60	26190301D	187,00	57	26225004	571,00	105
24219402LV	864,00	32	24247601LV	658,00	29	26110501AC	349,00	60	26190301KM	256,00	57	26225004	571,00	105
24219403	350,00	35	24247601LV	658,00	29	26110501BM	349,00	60	26190301KMB	256,00	57	26225004	571,00	105
24219403	350,00	499	24247602	458,00	28	26110501KMB	349,00	60	26190301NM	256,00	57	26225004	571,00	105
24219403AC	543,00	499	24247602AC	710,00	28	26110501LM	349,00	60	26190301OP	330,00	57	26225004	571,00	105
24219403LM	490,00	35	24247602LM	641,00	28	26110501LV	349,00	60	26190301OPM	330,00	57	26225004	571,00	105
24219403LV	490,00	499	24247602LV	641,00	28	26110501OM	450,00	60	26190301OPM	330,00	57	26225004	571,00	105
24219403OR	490,00	499	24250001	83,50	39	26110501OP	450,00	60	26190301TAM	256,00	57	26225004	571,00	105
24219501	894,00	34	24250001AC	129,00	39	26110501OPM	450,00	60	26212001	168,00	63	26225004	571,00	105
24219501AC	1.386,00	34	24250001LM	117,00	39	26110501OPM	450,00	60	26215001	485,00	350	26225004	571,00	105
24219501LM	1.252,00	34	24250001LV	117,00	39	26110501OPM	450,00	60	26215001	485,00	350	26225004	571,00	105
24219501LV	1.252,00	34	24250301											

REFERENCIA	€	Pág.	REFERENCIA	€	Pág.	REFERENCIA	€	Pág.	REFERENCIA	€	Pág.	REFERENCIA	€	Pág.
26225005OP	2.244,00	266	26228005OM	2.054,00	66	26230012OR	620,00	62	26290401OM	460,00	59	28125006	441,00	269
26225005OPM	2.244,00	266	26228005OP	2.054,00	317	26230701	297,00	58	26290401OP	460,00	59	28125006AC	684,00	269
26225005OR	2.244,00	266	26228005OP	2.054,00	66	26230701AC	460,00	58	26290401OPM	460,00	59	28125006NM	684,00	269
26225006	461,00	268	26228005OPM	2.054,00	317	26230701BM	460,00	58	26290401OR	460,00	59	28127810	75,00	113
26225006AC	715,00	268	26228005OPM	2.054,00	66	26230701KM	460,00	58	26290401TAM	357,00	59	28127810	75,00	303
26225006BM	715,00	268	26228005OR	2.054,00	317	26230701KMB	460,00	58	26290401TRO	357,00	59	28127810AC	116,00	113
26225006KM	715,00	268	26228005OR	2.054,00	66	26230701NM	460,00	58	26290402	220,00	59	28127810AC	116,00	303
26225006KMB	715,00	268	26228006	366,00	319	26230701OM	594,00	58	26290402AC	341,00	59	28127810NM	116,00	113
26225006NM	715,00	268	26228006	366,00	67	26230701OP	594,00	58	26290402BM	341,00	59	28127810NM	116,00	303
26225006OM	922,00	268	26228006AC	567,00	319	26230701OPM	594,00	58	26290402KM	341,00	59	28128004	446,00	114
26225006OP	922,00	268	26228006AC	567,00	67	26230701OR	594,00	58	26290402KMB	341,00	59	28128004	446,00	310
26225006OPM	922,00	268	26228006BM	567,00	319	26230701TAM	460,00	58	26290402NM	341,00	59	28128004AC	691,00	114
26225006OR	922,00	268	26228006BM	567,00	67	26230701TRO	460,00	58	26290402OM	440,00	59	28128004AC	691,00	310
26227810	85,00	303	26228006KM	567,00	319	26230801	325,00	58	26290402OP	440,00	59	28128004NM	691,00	114
26227810	85,00	65	26228006KMB	567,00	67	26230801AC	504,00	58	26290402OPM	440,00	59	28128004NM	691,00	310
26227810AC	132,00	303	26228006KMB	567,00	319	26230801BM	504,00	58	26290402OR	440,00	59	28128110	95,00	113
26227810AC	132,00	65	26228006KMB	567,00	67	26230801KM	504,00	58	26290402TAM	341,00	59	28128110	95,00	306
26227810BM	132,00	303	26228006NM	567,00	319	26230801KMB	504,00	58	26290402TRO	341,00	59	28128110AC	147,00	113
26227810BM	132,00	65	26228006NM	567,00	67	26230801NM	504,00	58	26290403	210,00	59	28128110AC	147,00	306
26227810KM	132,00	303	26228006OM	732,00	319	26230801OM	650,00	58	26290403AC	326,00	59	28128110NM	147,00	113
26227810KM	132,00	65	26228006OM	732,00	67	26230801OP	650,00	58	26290403BM	326,00	59	28128110NM	147,00	306
26227810KMB	132,00	303	26228006OP	732,00	319	26230801OPM	650,00	58	26290403KM	326,00	59	28130001	230,00	110
26227810KMB	132,00	65	26228006OP	732,00	67	26230801OR	650,00	58	26290403KMB	326,00	59	28130001AC	357,00	110
26227810NM	132,00	303	26228006OPM	732,00	319	26230801TAM	504,00	58	26290403NM	326,00	59	28130001NM	357,00	110
26227810NM	132,00	65	26228006OPM	732,00	67	26230801TRO	504,00	58	26290403OM	420,00	59	28130002	240,00	111
26227810OM	170,00	303	26228006OR	732,00	319	26247005	1.050,00	68	26290403OP	420,00	59	28130002AC	372,00	111
26227810OM	170,00	65	26228006OR	732,00	67	26247005AC	1.628,00	68	26290403OPM	420,00	59	28130002NM	372,00	111
26227810OP	170,00	303	26228110	110,00	306	26247005BM	1.628,00	68	26290403OR	420,00	59	28130003	270,00	111
26227810OP	170,00	65	26228110	110,00	65	26247005KM	1.628,00	68	26290403TAM	326,00	59	28130003AC	419,00	111
26227810OPM	170,00	303	26228110AC	171,00	306	26247005KMB	1.628,00	68	26290403TRO	326,00	59	28130003NM	419,00	111
26227810OPM	170,00	65	26228110AC	171,00	65	26247005NM	1.628,00	68				28130004	280,00	111
26227810OR	170,00	303	26228110BM	171,00	306	26247005OM	2.100,00	68				28130004AC	434,00	111
26227810OR	170,00	65	26228110BM	171,00	65	26247005OP	2.100,00	68	28110301	115,00	109	28130004NM	434,00	111
26228003	451,00	314	26228110KM	171,00	306	26247005OPM	2.100,00	68	28110301AC	178,00	109	28144701	200,00	110
26228003	451,00	66	26228110KM	171,00	65	26247005OR	2.100,00	68	28110301NM	178,00	109	28144701AC	310,00	110
26228003AC	699,00	314	26228110KMB	171,00	306	26247006	1.050,00	68	28110401	123,00	109	28144701NM	310,00	110
26228003AC	699,00	66	26228110KMB	171,00	65	26247006AC	1.628,00	68	28110401AC	191,00	109	28164701	210,00	110
26228003BM	699,00	314	26228110NM	171,00	306	26247006BM	1.628,00	68	28110401NM	191,00	109	28164701AC	326,00	110
26228003BM	699,00	66	26228110NM	171,00	65	26247006KM	1.628,00	68	28110402	127,00	109	28164701NM	326,00	110
26228003M	699,00	314	26228110OM	220,00	306	26247006KMB	1.628,00	68	28110402AC	197,00	109	28180301	260,00	110
26228003M	699,00	66	26228110OM	220,00	65	26247006NM	1.628,00	68	28110402NM	197,00	109	28180301AC	403,00	110
26228003KMB	699,00	314	26228110OP	220,00	306	26247006OM	2.100,00	68	28112001	122,00	111	28180301NM	403,00	110
26228003KMB	699,00	66	26228110OP	220,00	65	26247006OP	2.100,00	68	28112001AC	189,00	111	28184701	225,00	110
26228003NM	699,00	314	26228110OPM	220,00	306	26247006OPM	2.100,00	68	28112001NM	189,00	111	28184701AC	349,00	110
26228003NM	699,00	66	26228110OPM	220,00	65	26247006OR	2.100,00	68	28112301	180,00	111	28184701NM	349,00	110
26228003OM	902,00	314	26228110OR	220,00	306	26285305	550,00	61	28112301AC	279,00	111	28190301	119,00	109
26228003OM	902,00	66	26228110OR	220,00	65	26285305AC	853,00	61	28112301NM	279,00	111	28190301AC	184,00	109
26228003OP	902,00	314	26230001	262,00	62	26285305BM	853,00	61	28116701	230,00	112	28190301NM	184,00	109
26228003OP	902,00	66	26230001AC	406,00	62	26285305KMB	853,00	61	28116701AC	357,00	112	28310301	225,00	17
26228003OPM	902,00	314	26230001BM	406,00	62	26285305KMB	853,00	61	28116701NM	357,00	112	28310301AC	349,00	17
26228003OPM	902,00	66	26230001KM	406,00	62	26285305NM	853,00	61	28117001	250,00	112	28310301NM	349,00	17
26228003OR	902,00	314	26230001KMB	406,00	62	26285305OM	1.100,00	61	28117001AC	388,00	112	28310301OM	450,00	17
26228003OR	902,00	66	26230001NM	406,00	62	26285305OP	1.100,00	61	28117001NM	388,00	112	28310301OPM	450,00	17
26228004	476,00	309	26230001OM	524,00	62	26285305OPM	1.100,00	61	28119101	473,00	112	28310501	300,00	17
26228004	476,00	66	26230001OP	524,00	62	26285305OR	1.100,00	61	28119101	473,00	339	28310501AC	465,00	17
26228004AC	738,00	309	26230001OPM	524,00	62	26285306	550,00	61	28119101AC	733,00	112	28310501NM	465,00	17
26228004AC	738,00	66	26230001OR	524,00	62	26285306AC	853,00	61	28119101NM	733,00	112	28310501OM	600,00	17
26228004BM	738,00	309	26230002	272,00	62	26285306BM	853,00	61	28119101NM	733,00	112	28310501OPM	600,00	17
26228004BM	738,00	66	26230002AC	422,00	62	26285306KMB	853,00	61	28119101NM	733,00	339	28312001	228,00	18
26228004KM	738,00	309	26230002BM	422,00	62	26285306KMB	853,00	61	28119701	503,00	113	28312001AC	353,00	18
26228004KM	738,00	66	26230002KM	422,00	62	26285306NM	853,00	61	28119701	503,00	340	28312001NM	353,00	18
26228004KMB	738,00	309	26230002KMB	422,00	62	26285306OM	1.100,00	61	28119701AC	780,00	113	28312001OM	456,00	18
26228004KMB	738,00	66	26230002NM	422,00	62	26285306OP	1.100,00	61	28119701AC	780,00	340	28312001OPM	456,00	18
26228004NM	738,00	309	26230002OM	544,00	62	26285306OPM	1.100,00	61	28119701NM	780,00	113	28316301	320,00	18
26228004NM	738,00	66	26230002OP	544,00	62	26285306OR	1.100,00	61	28119701NM	780,00	340	28316301AC	496,00	18
26228004OM	952,00	309	26230002OPM	544,00	62	26285350	180,00	61	28120301	225,00	109	28316301NM	496,00	18
26228004OM	952,00	66	26230002OR	544,00	62	26285350	180,00	68	28120301AC	349,00	109	28316301OM	640,00	18
26228004OP	952,00	309	26230011	300,00	62	26290301	165,00	58	28120301NM	349,00	109	28316301OPM	640,00	18
26228004OP	952,00	66	26230011AC	465,00	62	26290301AC	256,00	58	28125001	110,00	257	28317601	385,00	18
26228004OPM	952,00	309	26230011BM	465,00	62	26290301BM	256,00	58	28125001AC	171,00	257	28317601AC	597,00	18
26228004OPM	952,00	66	26230011KM	465,00	62	26290301D	187,00	58	28125001NM	171,00	257	28317601NM	597,00	18
26228004OR	952,00	309	26230011KMB	465,00	62	26290301KM	256,00	58	28125003	525,00	264	28317601OM	770,00	18
26228004OR	952,00	66	26230011NM	465,00	62	26290301KMB	256,00	58	28125003AC	814,0				

REFERENCIA	€	Pág.	REFERENCIA	€	Pág.	REFERENCIA	€	Pág.	REFERENCIA	€	Pág.	REFERENCIA	€	Pág.
28325001AC	264,00	256	29963109LM	78,40	384	29990303NM	682,00	368	30725206AC	2.134,00	249	30735206NM	2.029,00	248
28325001NM	264,00	19	29963109LV	78,40	29	29990303OM	880,00	368	30725206NM	2.134,00	249	30735206OM	2.618,00	248
28325001NM	264,00	256	29963109LV	78,40	384	29990303OP	880,00	368	30725206OM	2.754,00	249	30735206OP	2.618,00	248
28325001OM	340,00	19	29963109OR	112,00	29	29990303OPM	880,00	368	30725206OP	2.754,00	249	30735206OPM	2.618,00	248
28325001OM	340,00	256	29963109OR	112,00	384	29990303OR	880,00	368	30725206OPM	2.754,00	249	30735206OR	2.618,00	248
28325001OPM	340,00	19	29963110	15,20	384	29990304	440,00	369	30725206OR	2.754,00	249	30735301	700,00	246
28325001OPM	340,00	256	29963111	25,20	383	29990304AC	682,00	369	30725207	1.197,00	249	30735301AC	1.085,00	246
28330001	275,00	17	29963112	40,00	383	29990304BM	682,00	369	30725207AC	1.855,00	249	30735301NM	1.085,00	246
28330001AC	426,00	17	29963112AC	62,00	383	29990304NM	682,00	369	30725207NM	1.855,00	249	30735301OM	1.400,00	246
28330001NM	426,00	17	29963112BM	62,00	383	29990304OM	880,00	369	30725207OM	2.394,00	249	30735301OP	1.400,00	246
28330001OM	550,00	17	29963112KM	62,00	383	29990304OR	880,00	369	30725207OP	2.394,00	249	30735301OPM	1.400,00	246
28330001OPM	550,00	17	29963112KMB	62,00	383	29990306	500,00	369	30725207OPM	2.394,00	249	30735301OR	1.400,00	246
28330002	285,00	18	29963112NM	62,00	383	29990306AC	775,00	369	30725207OR	2.394,00	249	30735401	700,00	247
28330002AC	442,00	18	29963112OM	80,00	383	29990306BM	775,00	369	30725301	720,00	246	30735401AC	1.085,00	247
28330002NM	442,00	18	29963112OPM	80,00	383	29990306NM	775,00	369	30725301AC	1.116,00	246	30735401NM	1.085,00	247
28330002OM	570,00	18	29963112OPM	80,00	383	29990306OM	1.000,00	369	30725301NM	1.116,00	246	30735401OM	1.400,00	247
28330002OPM	570,00	18	29963112OR	80,00	383	29990306OR	1.000,00	369	30725301NM	1.440,00	246	30735401OP	1.400,00	247
28380301	280,00	17	29963113	42,00	383	29990307	600,00	369	30725301OP	1.440,00	246	30735401OPM	1.400,00	247
28380301AC	434,00	17	29963113AC	65,10	383	29990307AC	930,00	369	30725301OPM	1.440,00	246	30735401OR	1.400,00	247
28380301NM	434,00	17	29963113BM	65,10	383	29990307BM	930,00	369	30725301OR	1.440,00	246			
28380301OM	560,00	17	29963113KM	65,10	383	29990307KM	930,00	369	30725305	1.477,00	250			
28380301OPM	560,00	17	29963113KMB	65,10	383	29990307KMB	930,00	369	30725305AC	2.289,00	250	39210301	195,00	433
			29963113NM	65,10	383	29990307NM	930,00	369	30725305NM	2.289,00	250	39210302	155,00	429
			29963113OM	84,00	383	29990307OM	1.200,00	369	30725305OM	2.954,00	250	39210303	300,00	430
			29963113OP	84,00	383	29990307OP	1.200,00	369	30725305OP	2.954,00	250	39210304	400,00	430
			29963113OPM	84,00	383	29990307OPM	1.200,00	369	30725305OPM	2.954,00	250	39210305	380,00	430
			29963113OR	84,00	383	29990307OR	1.200,00	369	30725305OR	2.954,00	250	39210306	480,00	430
			29963114	15,30	384	29990308	800,00	368	30725306	1.543,00	249	39210307	199,00	429
			29963115	24,00	382	29990308AC	1.240,00	368	30725306AC	2.392,00	249	39210308	298,00	431
			29963202	300,00	372	29990308BM	1.240,00	368	30725306NM	2.392,00	249	39210309	239,00	433
			29963202AC	465,00	372	29990308NM	1.240,00	368	30725306OM	3.086,00	249	39210319	390,00	431
			29963202BM	465,00	372	29995001	36,00	152	30725306OP	3.086,00	249	39210320	490,00	431
			29963202NM	465,00	372	29995301	770,00	364	30725306OPM	3.086,00	249	39210390	242,00	434
			29963202OM	600,00	372	29995301AC	1.194,00	364	30725306OR	3.086,00	249	39210391	194,00	434
			29963202OR	600,00	372	29995301BM	1.194,00	364	30725401	720,00	247	39210397	238,00	434
			29963203	350,00	372	29995301NM	1.194,00	364	30725401AC	1.116,00	247	39210399	286,00	434
			29963203AC	543,00	372	29995301OM	1.540,00	364	30725401NM	1.116,00	247	39274101	295,00	435
			29963203BM	543,00	372	29995301OR	1.540,00	364	30725401OM	1.440,00	247	39274102	300,00	435
			29963203NM	543,00	372	29995501	1.100,00	363	30725401OP	1.440,00	247	39274201	192,00	436
			29963203OM	700,00	372	29995501AC	1.705,00	363	30725401OPM	1.440,00	247	39274201AC	192,00	436
			29963203OR	700,00	372	29995501BM	1.705,00	363	30725401OR	1.440,00	247	39274201BL	192,00	436
			29963206	135,00	374	29995501NM	1.705,00	363	30725405	1.904,00	250			
			29963901	9,50	404	29995801	2.400,00	365	30725405AC	2.951,00	250			
			29963902	83,00	378	29996201	1.350,00	362	30725405NM	2.951,00	250	49286299	990,00	420
			29963902AC	129,00	378	29997001	1.400,00	362	30725405OM	3.808,00	250	49286299	990,00	232
			29963902BM	129,00	378	29997001AC	2.170,00	362	30725405OP	3.808,00	250	49286398	1.060,00	420
			29963902KMB	129,00	378	29997001BM	2.170,00	362	30725405OPM	3.808,00	250	49286398	1.060,00	232
			29963902NM	129,00	378	29997001NM	2.170,00	362	30725405OR	3.808,00	250	49286399	1.060,00	421
			29963902OM	166,00	378	29997001OR	2.800,00	362	30725406	1.971,00	250	49286399	1.060,00	233
			29963902OPM	166,00	378	29997101	1.500,00	362	30725406AC	3.055,00	250	49286499	1.130,00	421
			29963902OR	166,00	378	29997201	2.400,00	362	30725406NM	3.055,00	250	49286499	1.130,00	233
			29963910	38,00	404				30725406OM	3.942,00	250	49288299	990,00	420
			29963910AC	58,90	404				30725406OP	3.942,00	250	49288299	990,00	232
			29963910LM	53,20	404	30725201	620,00	246	30725406OPM	3.942,00	250	49288398	1.060,00	420
			29963910LV	53,20	404	30725201AC	961,00	246	30725406OR	3.942,00	250	49288398	1.060,00	232
			29963910OR	76,00	404	30725201NM	961,00	246	30735201	600,00	246	49288399	1.060,00	421
			29963928	6,30	404	30725201OM	1.240,00	246	30735201AC	930,00	246	49288399	1.060,00	233
			29966310	4,00	524	30725201OP	1.240,00	246	30735201NM	930,00	246	49288499	1.130,00	421
			29974802	29,00	385	30725201OPM	1.240,00	246	30735201OM	1.200,00	246	49288499	1.130,00	233
			29974901	32,00	382	30725201OR	1.240,00	246	30735201OP	1.200,00	246			
			29974904	44,00	382	30725204	859,00	248	30735201OPM	1.200,00	246			
			29974905	34,00	383	30725204AC	1.331,00	248	30735201OR	1.200,00	246	50643703	628,00	460
			29974906	38,00	383	30725204NM	1.331,00	248	30735204	803,00	247	50648603	620,00	444
			29987001	110,00	500	30725204OM	1.718,00	248	30735204	803,00	115	50716703	462,00	81
			29987002	120,00	499	30725204OP	1.718,00	248	30735204	803,00	104	5071700203	493,00	81
			29989601	18,00	527	30725204OPM	1.718,00	248	30735204AC	1.245,00	247	50783903	45,75	404
			29989602	16,00	527	30725204OR	1.718,00	248	30735204AC	1.245,00	115			
			29989603	19,50	527	30725205	1.187,00	248	30735204AC	1.245,00	104			
			29990301	740,00	368	30725205AC	1.187,00	89	30735204AC	1.245,00	70			
			29990301AC	1.147,00	368	30725205NM	1.840,00	248	30735204NM	1.245,00	247			
			29990301BM	1.147,00	368	30725205AC	1.840,00	89	30735204NM	1.245,00	115	53049603	457,00	444
			29990301NM	1.147,00	368	30725205AC	1.840,00	51	30735204NM	1.245,00	104	53049703	457,00	444
			29990301OM	1.480,00	368	30725205NM	1.840,00	248	30735204NM	1.245,00	70	53049803	465,00	444
			29990301OR	1.480,00	368	30725205OM	1.840,00	89	30735204NM	1.245,00	104			
			29990302	540,00	368	30725205OM	1.840,00	51	30735204OM	1.606,00	247			
			29990302AC	837,00	368	30725205OM	2.374,00	248	30735204OM	1.606,00	104			
			29990302BM	837,00	368	30725205OP	2.374,00	248	30735204OP	1.606,00	247			
			29990302NM	837,00	368	30725205OPM	2.374,00	248	30735204OPM	1.606,00	247			
			29990302OR	1.080,00	368	30725205OPM	2.374,00	248	30735204OPM	1.606,00	247			
			29990303	440,00	368	30725205OPM	2.374,00	248	30735204OPM	1.606,00	247			
			29990303AC	682,00	368	30725205OPM	2.							

REFERENCIA	€	Pág.	REFERENCIA	€	Pág.	REFERENCIA	€	Pág.
9130190	40,00	525	9134682	7,00	524	963033331	3,60	526
913043810	35,00	525	91346825	7,00	524	966110301	8,60	526
913049310	35,00	525	91346826	5,00	524			
913214591	120,00	525	9134683	7,50	525			
9133317	5,80	525	9134712	28,00	389			
913331703	10,00	527	9134725	11,30	385			
9133317031	2,00	527	9134731	32,50	389			
913400831	7,50	527	9134731051	80,00	389			
9134008311	1,50	527	913473810	34,50	380			
9134011	43,00	478	913474410	5,50	504			
913412380	30,00	382	913474420	5,70	504			
913414580	42,00	500	913474430	8,50	504			
9134235	46,00	525	9134745051	53,20	493			
9134250	11,30	526	9134746051	42,00	490			
9134256	11,30	526	9134779	9,50	505			
913427210	15,00	526	9134780	11,00	505			
913427220	15,00	526	9134781	6,10	504			
913427510	24,65	526	9134784	7,50	504			
9134282	15,00	526	9134786	11,00	505			
9134283	7,00	526	9134787	11,00	505			
9134284	7,00	526	9134788	11,00	505			
9134286	8,00	526	913478906	16,70	506			
9134288	40,00	525	913478907	14,50	506			
9134290	40,00	525	913478908	16,70	506			
9134292	15,00	526	9134803	8,50	526			
9134293	15,00	526	9134806	7,50	526			
9134294	9,00	526	913480810	18,20	380			
9134296	15,00	526	913481810	25,00	379			
9134314	20,00	525	9134828	17,80	388			
9134315	25,00	525	9134830051	80,00	388			
9134316	30,00	525	9134830053	80,00	388			
9134319	35,00	525	9134830054	160,00	388			
9134415	43,00	411	913483005LM	80,00	388			
9134441	30,00	525	913483080	19,80	388			
9134450	19,00	386	913484005	2,65	526			
9134481	70,00	525	9134840061	9,00	526			
9134515	57,00	410	913484007	9,35	526			
9134525	15,60	497	913484016	10,00	526			
9134525NM	24,20	497	913484026	15,00	526			
9134577	6,40	524	913484057	25,35	526			
9134591	40,00	525	9134841	7,20	405			
9134592	40,00	525	9134848	7,20	405			
9134609	23,00	387	9134849	30,00	525			
913460910	21,00	387	9134867	32,50	388			
913460912	22,00	387	9134872	34,50	500			
913460912AC	34,10	387	9134880	27,00	525			
913460912BM	34,10	387	9134881	32,00	389			
913460912NM	34,10	387	9134882	5,50	527			
913460915	22,50	387	9134887	33,50	389			
913460915AC	34,90	387	9134890	10,00	527			
913460915BM	34,90	387	9134891	6,35	527			
913460915KM	34,90	387	9134893	2,20	527			
913460915KMB	34,90	387	9134895	1,85	527			
913460915NM	34,90	387	9134896	1,85	527			
913460915OM	45,00	387	9134897	1,85	527			
913460915OP	45,00	387	9134898	2,20	527			
913460915OPM	45,00	387	9134915	34,00	411			
913460915OR	45,00	387	916110348	35,00	490			
913460920	23,50	387	9161515	123,00	409			
9134609AC	35,65	387	916184010	20,00	526			
9134609BM	35,65	387	916184060	27,00	491			
9134609KM	35,65	387	916218005	30,00	526			
9134609KMB	35,65	387	9162292	15,00	526			
9134609NM	35,65	387	9174441	30,00	525			
9134609OM	46,00	387	919210318	1,90	527			
9134609OP	46,00	387	919260634	11,00	526			
9134609OPM	46,00	387	919416401	2,20	527			
9134609OR	46,00	387	9194283	46,00	525			
9134615	28,00	411	9194552	120,00	525			
9134630	14,50	388						
913463250	17,00	497						
913463320	11,00	496	9262503	6,00	524			
913463330	11,00	496						
9134665	5,50	524						
9134666	5,50	524						
9134668	5,50	524						
9134672	5,00	524						
9134672501	10,00	524	953044052	7,00	527			
9134673	5,00	524	9530440521	1,40	527			
9134673501	10,00	524	953331550	7,00	527			
9134673503	10,00	524	9533315501	1,40	527			
9134674	6,00	524	953331750	7,00	527			
9134677	6,00	524	9533317501	1,40	527			
9134681	7,00	524	9534294501	1,40	527			
91346815	7,00	524						
91346816	5,00	524						

92

93

95

96

Condiciones generales de venta

PRECIOS SIN IMPUESTOS (SIN IVA)

Precios

Los precios de esta tarifa, y cualquier anexo que publiquemos, deben considerarse "precios de venta recomendados para el cliente final antes de impuestos".

Los precios están sujetos a cualquier variación según las circunstancias del mercado, materias primas, mano de obra, impuestos... facturándose los que rijan el día de la expedición.

Pedidos

Se considerarán condicionales y sujetos, por lo tanto, a nuestra consideración.

Diseño

Nuestros modelos podrán ser modificados por exigencias de diseño, sin previo aviso, siempre en beneficio del artículo.

La documentación fotográfica y/o el diseño técnico reproducidos en los listados, catálogos, folletos y demás instrumentos publicitarios tienen valor indicativo, por lo que el cliente no podrá acogerse a ellos en caso de posibles quejas por disconformidad o diferencia con los productos suministrados. Las reclamaciones referentes a la falta de conformidad de los productos suministrados deberán realizarse, como máximo, en los quince días siguientes a la entrega de la mercancía en su lugar de destino.

Plazo de entrega

Nuestros plazos de entrega son siempre aproximados y no nos hacemos responsables de las consecuencias de cualquier retraso.

Expedición de productos

La mercancía viajará a portes pagados siempre que el pedido neto importe un mínimo de 150€. Si la compra es inferior a esta cantidad, viajará a portes pagados también pero realizaremos un cargo en la factura de 6€ en concepto de transporte y gestión. Para las islas, si el importe del pedido asciende a un mínimo de 600€, la mercancía viajará a portes pagados, si no, viajará siempre a portes debidos. Informamos que nuestro departamento de logística gestiona los pedidos de forma independiente y no acumula los mismos para alcanzar el importe mencionado.

El destinatario comprobará, al recibo de la mercancía, el estado de la misma, indicando en el albarán del transportista las posibles incidencias.

Garantía Tres

TRES COMERCIAL S.A. garantiza todos los productos comercializados bajo la marca TRES ante eventuales defectos estructurales, de material o de fabricación durante 3 años a partir de la fecha de compra por parte del consumidor final.

Adicionalmente, TRES COMERCIAL S.A., ofrece una Garantía Comercial de 2 años adicionales (**Garantía de 5 años en total**), exceptuando:

- Revestimientos de acabados especiales (aquellos distintos del cromo).
- Grifería electrónica distinta del producto Shower Technology Blue Edition.
- Columnas de ducha, cartuchos temporizados.
- Complementos y accesorios (flexos, mandos de ducha, rociadores, soportes, llaves de paso, etc.)
- Materiales de consumo (filtros, juntas, aireadores, etc.)

Esta garantía no modifica los derechos que la legislación local otorga al consumidor final frente al comercializador del producto y frente al fabricante en el caso de haber sido adquirido en un distribuidor oficial.

Prerrequisitos de la Garantía

Para ejercer una reclamación de garantía es condición indispensable la presentación de una factura de compra donde se identifique claramente la fecha de compra y el distribuidor autorizado.

Para ejercer una reclamación de garantía el producto debe estar correctamente instalado, el uso debe haber sido de acuerdo con lo esperado para ese producto y la limpieza y mantenimiento debe haberse realizado de acuerdo a las indicaciones recogidas en el manual.

Servicios dentro del plazo de la Garantía

TRES COMERCIAL S.A. tiene la potestad de decidir la gestión a realizar, según la tipología del producto, entre la reparación por un Servicio Técnico Oficial, el suministro de un recambio para la reparación, la reparación en las instalaciones de TRES COMERCIAL S.A. o el cambio por un producto igual o similar en el caso de que el producto esté discontinuado.

Condiciones y exclusiones

TRES COMERCIAL S.A. se exime de toda responsabilidad:

· Si el producto no se ha instalado, mantenido y limpiado conforme a las instrucciones del mismo, incluidas en cada producto y disponibles en www.tresgriferia.com

· Si el producto no ha recibido el uso esperado para la tipología de producto.

· Si monta piezas no originales o evidencia signos de manipulación indebida.

· Si los defectos son resultado del transporte y/o la instalación.

· Si los elementos reclamados son aquellos sujetos a desgaste y éste es el normal para el uso dado.

· Si el defecto se produce por elementos externos agresivos (químicos, productos de limpieza corrosivos, instalación en ambientes agresivos, exceso de cal, hielo...)

· Si el defecto se produce por circunstancias ambientales (variaciones de presión, temperaturas extremas...)

· En caso de faltar un componente si éste no se ha reclamado en un plazo de 30 días desde la fecha de compra.

Límites de la Garantía

La eventual reparación, sustitución o cualquier prestación de servicio sobre el producto afectado, no extiende esta Garantía Comercial.

Para que esta Garantía sea válida, es necesario en cada caso, la aceptación del defecto por nuestro departamento técnico. En caso de que el producto analizado no presente ningún defecto cubierto por esta Garantía, se procederá a los siguientes cargos en concepto de Servicio Técnico:

· 12 € (IVA incluido) más gastos de transporte en el caso de análisis del defecto en las instalaciones de TRES COMERCIAL S.A.

· Tarifa oficial del Servicio Técnico (a disposición de los clientes a través del dpto. Comercial) en caso de atención por parte del Servicio Técnico en la instalación.

La Garantía Comercial cubre únicamente la reparación o reposición del material sin cargo alguno para el cliente, y sin que en ningún caso podamos hacernos responsables de los daños y perjuicios que por su defecto haya podido producirse directa o indirectamente.

Pago

El importe de las facturas, salvo acuerdos especiales, será cancelado mediante giro SEPA B2B como máximo a 30 días fecha factura.

Reserva de dominio

TRES COMERCIAL SA será propietario de todos los productos suministrados al cliente, hasta el cobro completo de la factura correspondiente.

MUY IMPORTANTE

Devoluciones

TRES COMERCIAL SA no aceptará ninguna devolución de mercancía sin que previamente nuestro representante lo haya aceptado y comunicado.

1) TRES COMERCIAL SA no acepta ninguna devolución sin la aceptación previa (la mercancía se devolverá al remitente).

2) TRES COMERCIAL SA no acepta ninguna devolución de mercancía que pueda repararse con recambios originales.

3) TRES COMERCIAL SA no acepta ninguna devolución de mercancía fuera de garantía.

4) No obstante, en caso de recepcionar mercancía perfectamente encajada, esta sufrirá una depreciación en factura de:

· Si es del año en curso: *-15% depreciación*

· Si es anterior a dos años: *-30% depreciación*

· Si es anterior a 3 años: *-60% depreciación*

Los envíos de mercaderías deberán efectuarse a portes pagados por el cliente.

TRÈS

www.tresgriferia.com

C/ Penedès, 16-26
Zona Industrial, Sector A
08759 Vallirana (Barcelona)

España

comercial@tresgriferia.com
+34 93 683 40 27

Portugal

portugal@tresgriferia.com
+351 707 502 134



sat@tresgriferia.com
+34 93 683 41 34

AENOR

GESTIÓN
DE LA CALIDAD
ISO 9001

ER-1111/1999



8 429546 574011

REF. 7342023010 / ED. 01-2023