

Revisión B

23/01



TARIFA DE PRECIOS

Batsur S.L.

FORMATO DIGITAL



Revisión B



Revisión B
23/01

MOD.BS TP 01.05.23 (B)

BATERÍAS

Revisión B

23/01

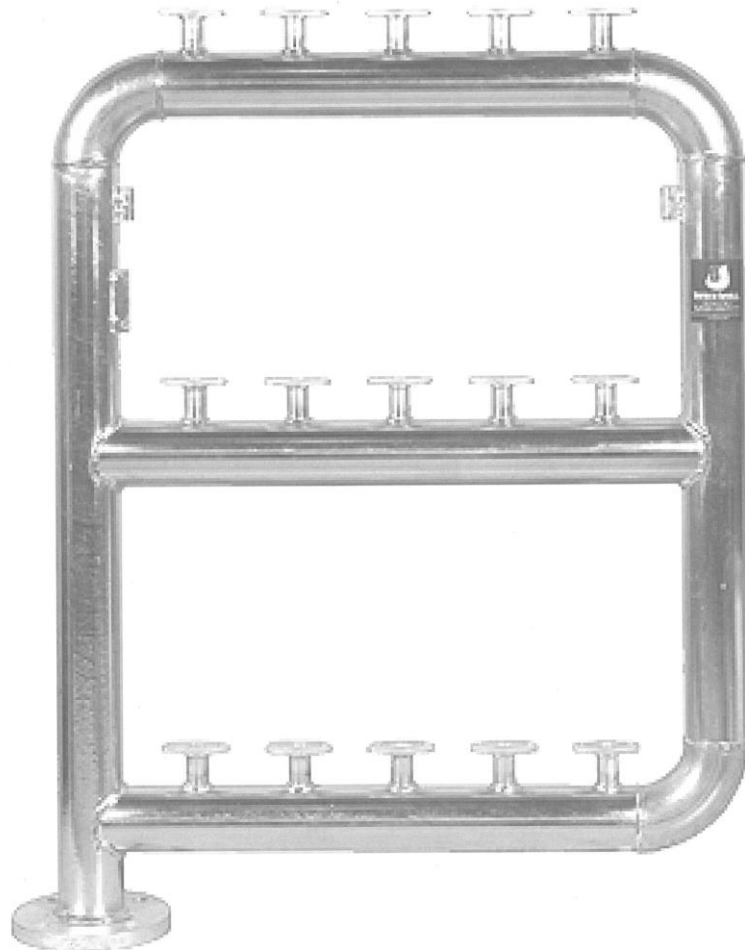

Revisión B

ÍNDICE

PAG. 5-26..... BATERÍAS PARA CENTRALIZACIÓN DE CONTADORES

PAG. 27-33..... ACCESORIOS PARA CENTRALIZACIÓN DE CONTADORES

PAG. 34..... ACCESORIOS PARA GRUPOS DE PRESIÓN

PAG. 35..... TORNILLERÍA

Revisión B

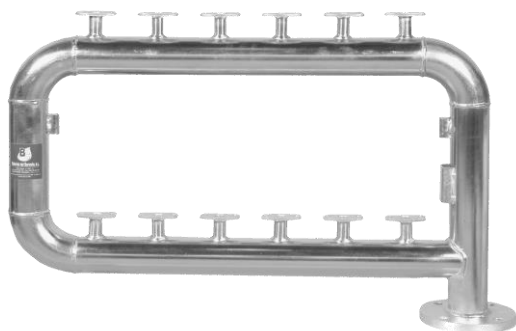

BATERÍAS ACERO GALVANIZADO MODELO CUADRO CIRCUITO CERRADO 2 FILAS

N° CONTADORES	FILAS	PULGADAS	REF.	EUROS	PESO UNID.
4	2	2"	20042	170,22	12,000
6	2	2"	20062	194,68	13,500
8	2	2 1/2"	20082	262,43	18,000
10	2	2 1/2"	20102	288,58	20,000
12	2	2 1/2"	20122	312,74	21,500
14	2	2 1/2"	20142	337,97	23,000
16	2	2 1/2"	20162	363,10	24,500
18	2	2 1/2"	20182	389,35	26,000
20	2	2 1/2"	20202	412,85	27,500
22	2	2 1/2"	20222	436,82	29,000
24	2	2 1/2"	20242	459,34	30,500
26	2	2 1/2"	20262	488,76	32,000
28	2	2 1/2"	20282	515,71	33,500
30	2	2 1/2"	20302	537,88	35,000

INCLUIDO KIT DE MONTAJE

BATERÍAS ACERO GALVANIZADO MODELO CUADRO CIRCUITO CERRADO 3 FILAS

N° CONTADORES	FILAS	PULGADAS	REF.	EUROS	PESO UNID.
6	3	2"	30063	232,05	16,500
9	3	2 1/2"	30093	330,78	24,000
12	3	2 1/2"	30123	365,01	26,000
15	3	2 1/2"	30153	402,97	28,500
18	3	2 1/2"	30183	443,08	31,000
21	3	2 1/2"	30213	480,18	33,000
24	3	2 1/2"	30243	517,24	35,000
27	3	2 1/2"	30273	556,37	37,000
30	3	2 1/2"	30303	591,64	39,500
33	3	3"	30333	753,86	55,000
36	3	3"	30363	803,15	58,000
39	3	3"	30393	856,06	62,000
42	3	3"	30423	903,21	65,500
45	3	3"	30453	950,23	69,000

INCLUIDO KIT DE MONTAJE

Revisión B

**BATERÍAS ACERO GALVANIZADO
 MODELO CUADRO CIRCUITO CERRADO 2 FILAS SUPERIOR**

N° CONTADORES	FILAS	PULGADAS	REF.	EUROS	PESO UNID.
4	2	2"	20042S	178,73	12,000
6	2	2"	20062S	204,41	13,500
8	2	2 1/2"	20082S	275,55	18,000
10	2	2 1/2"	20102S	303,01	20,000
12	2	2 1/2"	20122S	328,38	21,500
14	2	2 1/2"	20142S	354,87	23,000
16	2	2 1/2"	20162S	381,26	24,500
18	2	2 1/2"	20182S	408,82	26,000
20	2	2 1/2"	20202S	433,49	27,500
22	2	2 1/2"	20222S	458,66	29,000
24	2	2 1/2"	20242S	482,31	30,500
26	2	2 1/2"	20262S	513,20	32,000
28	2	2 1/2"	20282S	541,50	33,500
30	2	2 1/2"	20302S	564,77	35,000

INCLUIDO KIT DE MONTAJE

**BATERÍAS ACERO GALVANIZADO
 MODELO CUADRO CIRCUITO CERRADO 3 FILAS SUPERIOR**

N° CONTADORES	FILAS	PULGADAS	REF.	EUROS	PESO UNID.
6	3	2"	30063S	243,65	16,500
9	3	2 1/2"	30093S	347,32	24,000
12	3	2 1/2"	30123S	383,26	26,000
15	3	2 1/2"	30153S	423,12	28,500
18	3	2 1/2"	30183S	465,23	31,000
21	3	2 1/2"	30213S	504,19	33,000
24	3	2 1/2"	30243S	543,10	35,000
27	3	2 1/2"	30273S	584,19	37,000
30	3	2 1/2"	30303S	621,22	39,500
33	3	3"	30333S	791,55	55,000
36	3	3"	30363S	843,31	58,000
39	3	3"	30393S	898,86	62,000
42	3	3"	30423S	948,37	65,500
45	3	3"	30453S	997,74	69,000

INCLUIDO KIT DE MONTAJE

Revisión B

**BATERÍAS ACERO GALVANIZADO
MODELO CUADRO CIRCUITO CERRADO 2 FILAS LATERAL INFERIOR Y SUPERIOR**



Nº CONTADORES	FILAS	PULGADAS	REF. INFERIOR	EUROS	REF. SUPERIOR	EUROS	PESO UNID.
4	2	2"	20042LI	182,14	20042LS	182,14	12,000
6	2	2"	20062LI	208,31	20062LS	208,31	13,500
8	2	2 1/2"	20082LI	280,80	20082LS	280,80	18,000
10	2	2 1/2"	20102LI	308,78	20102LS	308,78	20,000
12	2	2 1/2"	20122LI	334,63	20122LS	334,63	21,500
14	2	2 1/2"	20142LI	361,63	20142LS	361,63	23,000
16	2	2 1/2"	20162LI	388,52	20162LS	388,52	24,500
18	2	2 1/2"	20182LI	416,60	20182LS	416,60	26,000
20	2	2 1/2"	20202LI	441,75	20202LS	441,75	27,500
22	2	2 1/2"	20222LI	467,40	20222LS	467,40	29,000
24	2	2 1/2"	20242LI	491,49	20242LS	491,49	30,500
26	2	2 1/2"	20262LI	522,97	20262LS	522,97	32,000
28	2	2 1/2"	20282LI	551,81	20282LS	551,81	33,500
30	2	2 1/2"	20302LI	575,53	20302LS	575,53	35,000

INCLUIDO KIT DE MONTAJE

**BATERÍAS ACERO GALVANIZADO
MODELO CUADRO CIRCUITO CERRADO 3 FILAS LATERAL INFERIOR Y SUPERIOR**



Nº CONTADORES	FILAS	PULGADAS	REF. INFERIOR	EUROS	REF. SUPERIOR	EUROS	PESO UNID.
6	3	2"	30063LI	248,29	30063LS	248,29	16,500
9	3	2 1/2"	30093LI	353,93	30093LS	353,93	24,000
12	3	2 1/2"	30123LI	390,56	30123LS	390,56	26,000
15	3	2 1/2"	30153LI	431,18	30153LS	431,18	28,500
18	3	2 1/2"	30183LI	474,10	30183LS	474,10	31,000
21	3	2 1/2"	30213LI	513,79	30213LS	513,79	33,000
24	3	2 1/2"	30243LI	553,45	30243LS	553,45	35,000
27	3	2 1/2"	30273LI	595,32	30273LS	595,32	37,000
30	3	2 1/2"	30303LI	633,05	30303LS	633,05	39,500
33	3	3"	30333LI	806,63	30333LS	806,63	55,000
36	3	3"	30363LI	859,37	30363LS	859,37	58,000
39	3	3"	30393LI	915,98	30393LS	915,98	62,000
42	3	3"	30423LI	966,43	30423LS	966,43	65,500
45	3	3"	30453LI	1.016,75	30453LS	1.016,75	69,000

INCLUIDO KIT DE MONTAJE

Revisión B

BATERÍAS ACERO GALVANIZADO
MODELO CUADRO CIRCUITO CERRADO 2 FILAS CENTRAL Y CENTRAL SUPERIOR Y/O ACODADA



N° CONTADORES	FILAS	PULGADAS	REF. CENTRAL	EUROS	REF. CENTRAL SUPERIOR	EUROS	PESO UNID.
4	2	2"	20042C	187,24	20042CS	187,24	12,000
6	2	2"	20062C	218,04	20062CSA	219,99	13,500
8	2	2 1/2"	20082C	288,67	20082CS	288,67	18,000
10	2	2 1/2"	20102C	317,44	20102CSA	323,21	20,000
12	2	2 1/2"	20122C	344,01	20122CS	344,01	21,500
14	2	2 1/2"	20142C	371,77	20142CSA	378,53	23,000
16	2	2 1/2"	20162C	399,41	20162CS	399,41	24,500
18	2	2 1/2"	20182C	428,29	20182CSA	436,07	26,000
20	2	2 1/2"	20202C	454,14	20202CS	454,14	27,500
22	2	2 1/2"	20222C	480,50	20222CSA	489,24	29,000
24	2	2 1/2"	20242C	505,27	20242CS	505,27	30,500
26	2	2 1/2"	20262C	537,64	20262CSA	547,41	32,000
28	2	2 1/2"	20282C	567,28	20282CS	567,28	33,500
30	2	2 1/2"	20302C	591,67	20302CSA	602,43	35,000

INCLUIDO KIT DE MONTAJE

BATERÍAS ACERO GALVANIZADO
MODELO CUADRO CIRCUITO CERRADO 3 FILAS CENTRAL Y CENTRAL SUPERIOR Y/O ACODADA

Revisión B



N° CONTADORES	FILAS	PULGADAS	REF. CENTRAL	EUROS	REF. CENTRAL SUPERIOR	EUROS	PESO UNID.
6	3	2"	30063C	255,26	30063CS	255,26	16,500
9	3	2 1/2"	30093C	367,17	30093CSA	370,47	24,000
12	3	2 1/2"	30123C	401,51	30123CS	401,51	26,000
15	3	2 1/2"	30153C	443,27	30153CSA	451,33	28,500
18	3	2 1/2"	30183C	487,39	30183CS	487,39	31,000
21	3	2 1/2"	30213C	528,20	30213CSA	537,80	33,000
24	3	2 1/2"	30243C	568,96	30243CS	568,96	35,000
27	3	2 1/2"	30273C	612,01	30273CSA	623,13	37,000
30	3	2 1/2"	30303C	650,80	30303CS	650,80	39,500
33	3	3"	30333C	829,25	30333CSA	844,32	55,000
36	3	3"	30363C	883,47	30363CS	883,47	58,000
39	3	3"	30393C	941,67	30393CSA	958,79	62,000
42	3	3"	30423C	993,53	30423CS	993,53	65,500
45	3	3"	30453C	1.045,25	30453CSA	1.064,26	69,000

INCLUIDO KIT DE MONTAJE

BATERÍAS ACERO GALVANIZADO
MODELO CUADRO CIRCUITO CERRADO 2 FILAS CON DOBLE ALIMENTACIÓN

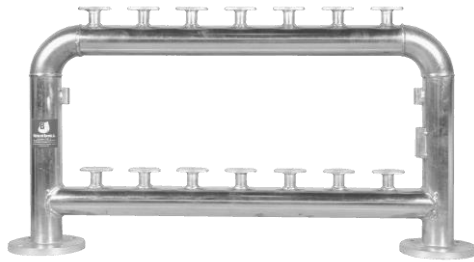

Nº CONTADORES	FILAS	PULGADAS	REF.	EUROS	PESO UNID.
18	2	2 1/2"	40182	427,60	33,000
20	2	2 1/2"	40202	450,26	34,500
22	2	2 1/2"	40222	473,39	36,000
24	2	2 1/2"	40242	495,11	37,500
26	2	2 1/2"	40262	518,33	39,000
28	2	2 1/2"	40282	549,48	40,500
30	2	2 1/2"	40302	570,86	42,000

INCLUIDO KIT DE MONTAJE

BATERÍAS ACERO GALVANIZADO
MODELO CUADRO CIRCUITO CERRADO 3 FILAS CON DOBLE ALIMENTACIÓN



Nº CONTADORES	FILAS	PULGADAS	REF.	EUROS	PESO UNID.
18	3	2 1/2"	50183	479,19	38,000
21	3	2 1/2"	50213	514,97	40,000
24	3	2 1/2"	50243	550,71	42,000
27	3	2 1/2"	50273	588,46	44,000
30	3	2 1/2"	50303	622,48	46,000
33	3	3"	50333	801,99	63,000
36	3	3"	50363	849,82	66,500
39	3	3"	50393	900,85	70,500
42	3	3"	50423	947,23	74,000
45	3	3"	50453	1.000,42	77,500

INCLUIDO KIT DE MONTAJE

Revisión B

BATERÍAS VERSIÓN ACERO GALVANIZADO 1 FILA



Nº CONTADORES	FILAS	REF.	EUROS	PESO UNID.
1	1	10011	18,32	1,000
2	1	10021	104,43	5,500
3	1	10031	126,72	7,000
4	1	10041	154,14	10,500
5	1	10051	172,59	11,500
6	1	10061	184,36	12,500

INCLUIDO KIT DE MONTAJE

BATERÍAS VERSIÓN ACERO GALVANIZADO 2 FILAS



Nº CONTADORES	FILAS	REF.	EUROS	PESO UNID.
2	2	10022	105,92	5,000
4	2	10042	142,75	8,500
6	2	10062	186,56	10,000
8	2	10082	232,67	13,000
10	2	10102	266,96	14,500

INCLUIDO KIT DE MONTAJE

BATERÍAS VERSIÓN ACERO GALVANIZADO HORIZONTAL



Nº CONTADORES	REF.	EUROS	PESO UNID.
2	12002	91,22	5,000
3	12003	107,79	6,000

INCLUIDO KIT DE MONTAJE

BATERÍAS VERSIÓN ACERO GALVANIZADO HORIZONTAL CON CODO



Nº CONTADORES	REF.	EUROS	PESO UNID.
2	11002	100,60	5,500
3	11003	117,21	6,500

INCLUIDO KIT DE MONTAJE

Revisión B

BATERÍAS POLIPROPILENO CIRCUITO CERRADO 2 FILAS

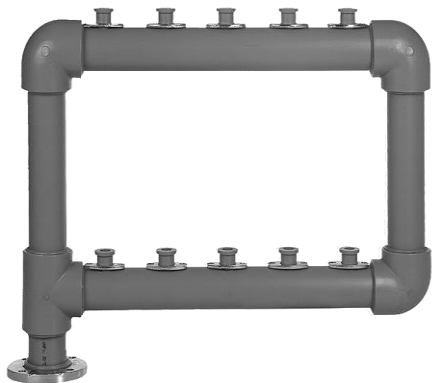

Nº CONTADORES	FILAS	Ø	PULGADAS	REF.	EUROS	PESO UNID.
4	2	63	2"	PPR71042	127,21	7,800
6	2	63	2"	PPR71062	135,83	8,600
8	2	75	2 1/2"	PPR71082	183,31	13,900
10	2	75	2 1/2"	PPR71102	193,34	14,900
12	2	75	2 1/2"	PPR71122	214,63	15,900
14	2	75	2 1/2"	PPR71142	232,89	16,900
16	2	75	2 1/2"	PPR71162	243,75	18,300
18	2	75	2 1/2"	PPR71182	254,61	18,900
20	2	75	2 1/2"	PPR71202	265,46	19,900
22	2	75	2 1/2"	PPR71222	280,03	20,900
24	2	75	2 1/2"	PPR71242	290,89	21,900
26	2	75	2 1/2"	PPR71262	301,74	22,900
28	2	75	2 1/2"	PPR71282	316,31	23,900
30	2	75	2 1/2"	PPR71302	327,17	24,900

INCLUIDO KIT DE MONTAJE

BATERÍAS POLIPROPILENO CIRCUITO CERRADO 3 FILAS

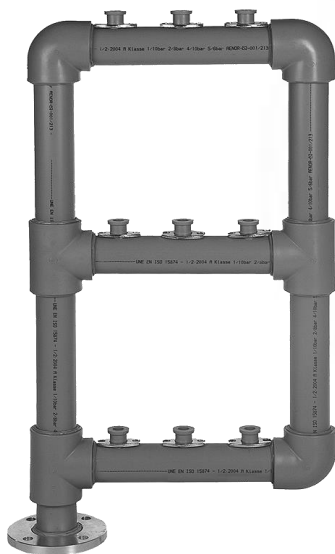

Nº CONTADORES	FILAS	Ø	PULGADAS	REF.	EUROS	PESO UNID.
6	3	63	2"	PPR72063	182,75	16,400
9	3	75	2 1/2"	PPR72093	251,16	17,600
12	3	75	2 1/2"	PPR72123	267,45	18,800
15	3	75	2 1/2"	PPR72153	283,73	20,000
18	3	75	2 1/2"	PPR72183	303,73	21,200
21	3	75	2 1/2"	PPR72213	320,01	22,400
24	3	75	2 1/2"	PPR72243	336,30	23,600
27	3	75	2 1/2"	PPR72273	352,59	24,800
30	3	75	2 1/2"	PPR72303	368,87	25,000
33	3	90	3"	PPR72333	546,25	28,100
36	3	90	3"	PPR72363	566,71	29,000
39	3	90	3"	PPR72393	587,17	29,900
42	3	90	3"	PPR72423	607,63	30,800
45	3	90	3"	PPR72453	628,09	31,700

INCLUIDO KIT DE MONTAJE

Revisión B

**BATERÍAS POLIPROPILENO
MODELO CIRCUITO CERRADO 2 FILAS SUPERIOR**

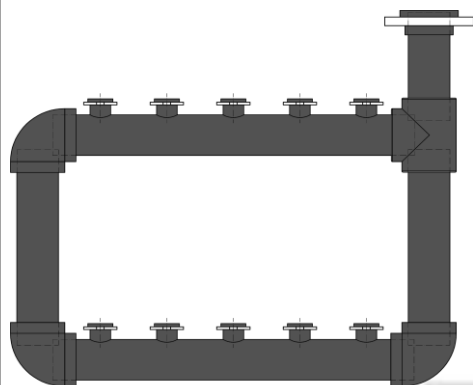

Nº CONTADORES	FILAS	Ø	PULGADAS	REF.	EUROS	PESO UNID.
4	2	63	2"	PPR71042S	129,75	7,800
6	2	63	2"	PPR71062S	138,55	8,600
8	2	75	2 1/2"	PPR71082S	186,98	13,900
10	2	75	2 1/2"	PPR71102S	197,21	14,900
12	2	75	2 1/2"	PPR71122S	218,92	15,900
14	2	75	2 1/2"	PPR71142S	237,55	16,900
16	2	75	2 1/2"	PPR71162S	248,63	18,300
18	2	75	2 1/2"	PPR71182S	259,70	18,900
20	2	75	2 1/2"	PPR71202S	270,77	19,900
22	2	75	2 1/2"	PPR71222S	285,63	20,900
24	2	75	2 1/2"	PPR71242S	296,71	21,900
26	2	75	2 1/2"	PPR71262S	307,77	22,900
28	2	75	2 1/2"	PPR71282S	322,64	23,900
30	2	75	2 1/2"	PPR71302S	333,71	24,900

INCLUIDO KIT DE MONTAJE

**BATERÍAS POLIPROPILENO
MODELO CIRCUITO CERRADO 3 FILAS SUPERIOR**

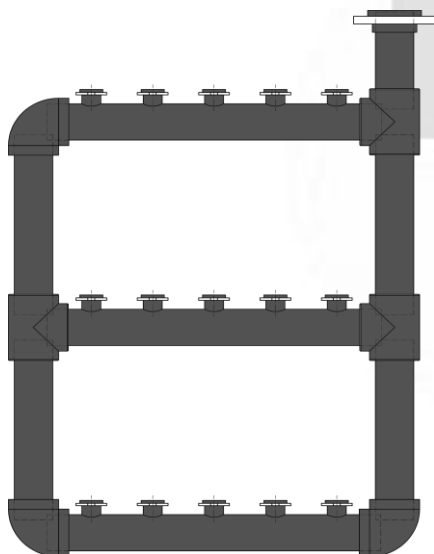

Nº CONTADORES	FILAS	Ø	PULGADAS	REF.	EUROS	PESO UNID.
6	3	63	2"	PPR72063S	186,41	16,400
9	3	75	2 1/2"	PPR72093S	256,18	17,600
12	3	75	2 1/2"	PPR72123S	272,80	18,800
15	3	75	2 1/2"	PPR72153S	289,40	20,000
18	3	75	2 1/2"	PPR72183S	309,80	21,200
21	3	75	2 1/2"	PPR72213S	326,41	22,400
24	3	75	2 1/2"	PPR72243S	343,03	23,600
27	3	75	2 1/2"	PPR72273S	359,64	24,800
30	3	75	2 1/2"	PPR72303S	376,25	25,000
33	3	90	3"	PPR72333S	557,18	28,100
36	3	90	3"	PPR72363S	578,04	29,000
39	3	90	3"	PPR72393S	598,91	29,900
42	3	90	3"	PPR72423S	619,78	30,800
45	3	90	3"	PPR72453S	640,65	31,700

INCLUIDO KIT DE MONTAJE

Revisión B

**BATERÍAS POLIPROPILENO
MODELO CIRCUITO CERRADO 2 FILAS LATERAL INFERIOR Y SUPERIOR**



N° CONTADORES	FILAS	Ø	PULGADAS	REF. INFERIOR	EUROS	REF. SUPERIOR	EUROS	PESO UNID.
4	2	63	2"	PPR71042LI	143,75	PPR71042LS	143,75	7,800
6	2	63	2"	PPR71062LI	153,49	PPR71062LS	153,49	8,600
8	2	75	2 1/2"	PPR71082LI	210,81	PPR71082LS	210,81	13,900
10	2	75	2 1/2"	PPR71102LI	222,34	PPR71102LS	222,34	14,900
12	2	75	2 1/2"	PPR71122LI	233,95	PPR71122LS	233,95	15,900
14	2	75	2 1/2"	PPR71142LI	249,19	PPR71142LS	249,19	16,900
16	2	75	2 1/2"	PPR71162LI	260,81	PPR71162LS	260,81	18,300
18	2	75	2 1/2"	PPR71182LI	272,43	PPR71182LS	272,43	18,900
20	2	75	2 1/2"	PPR71202LI	284,04	PPR71202LS	284,04	19,900
22	2	75	2 1/2"	PPR71222LI	299,63	PPR71222LS	299,63	20,900
24	2	75	2 1/2"	PPR71242LI	311,25	PPR71242LS	311,25	21,900
26	2	75	2 1/2"	PPR71262LI	322,86	PPR71262LS	322,86	22,900
28	2	75	2 1/2"	PPR71282LI	338,45	PPR71282LS	338,45	23,900
30	2	75	2 1/2"	PPR71302LI	350,07	PPR71302LS	350,07	24,900

INCLUIDO KIT DE MONTAJE

**BATERÍAS POLIPROPILENO
MODELO CIRCUITO CERRADO 3 FILAS LATERAL INFERIOR Y SUPERIOR**



N° CONTADORES	FILAS	Ø	PULGADAS	REF. INFERIOR	EUROS	REF. SUPERIOR	EUROS	PESO UNID.
6	3	63	2"	PPR72063LI	195,54	PPR72063LS	195,54	16,400
9	3	75	2 1/2"	PPR72093LI	268,74	PPR72093LS	268,74	17,600
12	3	75	2 1/2"	PPR72123LI	286,17	PPR72123LS	286,17	18,800
15	3	75	2 1/2"	PPR72153LI	303,59	PPR72153LS	303,59	20,000
18	3	75	2 1/2"	PPR72183LI	324,99	PPR72183LS	324,99	21,200
21	3	75	2 1/2"	PPR72213LI	342,41	PPR72213LS	342,41	22,400
24	3	75	2 1/2"	PPR72243LI	359,84	PPR72243LS	359,84	23,600
27	3	75	2 1/2"	PPR72273LI	377,27	PPR72273LS	377,27	24,800
30	3	75	2 1/2"	PPR72303LI	394,69	PPR72303LS	394,69	25,000
33	3	90	3"	PPR72333LI	584,49	PPR72333LS	584,49	28,100
36	3	90	3"	PPR72363LI	606,38	PPR72363LS	606,38	29,000
39	3	90	3"	PPR72393LI	628,27	PPR72393LS	628,27	29,900
42	3	90	3"	PPR72423LI	650,16	PPR72423LS	650,16	30,800
45	3	90	3"	PPR72453LI	672,06	PPR72453LS	672,06	31,700

INCLUIDO KIT DE MONTAJE

Revisión B

BATERÍAS POLIPROPILENO
MODELO CIRCUITO CERRADO 2 FILAS CENTRAL Y CENTRAL SUPERIOR ACODADA Y/O ACODADA

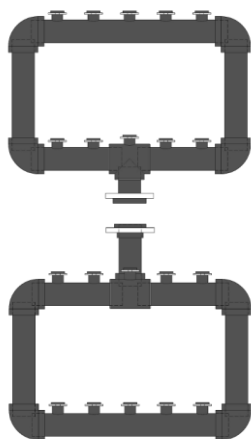

N° CONTADORES	FILAS	Ø	PULGADAS	REF. CENTRAL	EUROS	REF. CENTRAL SUPERIOR	EUROS	PESO UNID.
4	2	63	2"	PPR71042C	155,20	PPR71042CS	174,28	7,800
6	2	63	2"	PPR71062C	164,35	PPR71062CSA	173,59	8,600
8	2	75	2 1/2"	PPR71082C	234,64	PPR71082CS	236,47	13,900
10	2	75	2 1/2"	PPR71102C	245,54	PPR71102CSA	262,94	14,900
12	2	75	2 1/2"	PPR71122C	257,56	PPR71122CS	265,07	15,900
14	2	75	2 1/2"	PPR71142C	270,85	PPR71142CSA	287,62	16,900
16	2	75	2 1/2"	PPR71162C	282,02	PPR71162CS	289,58	18,300
18	2	75	2 1/2"	PPR71182C	293,31	PPR71182CSA	310,62	18,900
20	2	75	2 1/2"	PPR71202C	304,75	PPR71202CS	306,08	19,900
22	2	75	2 1/2"	PPR71222C	320,07	PPR71222CSA	331,00	20,900
24	2	75	2 1/2"	PPR71242C	331,61	PPR71242CS	338,01	21,900
26	2	75	2 1/2"	PPR71262C	342,78	PPR71262CSA	359,07	22,900
28	2	75	2 1/2"	PPR71282C	358,38	PPR71282CS	365,65	23,900
30	2	75	2 1/2"	PPR71302C	369,70	PPR71302CSA	386,71	24,900

INCLUIDO KIT DE MONTAJE

BATERÍAS POLIPROPILENO
MODELO CIRCUITO CERRADO 3 FILAS CENTRAL Y CENTRAL SUPERIOR ACODADA Y/O ACODADA

Revisión B

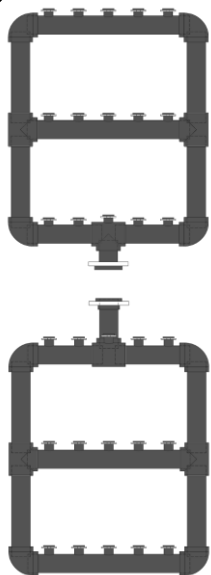

N° CONTADORES	FILAS	Ø	PULGADAS	REF. CENTRAL	EUROS	REF. CENTRAL SUPERIOR	EUROS	PESO UNID.
6	3	63	2"	PPR72063C	214,73	PPR72063CS	222,77	16,400
9	3	75	2 1/2"	PPR72093C	289,84	PPR72093CSA	307,17	17,600
12	3	75	2 1/2"	PPR72123C	307,03	PPR72123CS	309,17	18,800
15	3	75	2 1/2"	PPR72153C	323,45	PPR72153CSA	335,94	20,000
18	3	75	2 1/2"	PPR72183C	344,73	PPR72183CS	356,28	21,200
21	3	75	2 1/2"	PPR72213C	361,61	PPR72213CSA	379,53	22,400
24	3	75	2 1/2"	PPR72243C	379,35	PPR72243CS	390,44	23,600
27	3	75	2 1/2"	PPR72273C	396,31	PPR72273CSA	413,94	24,800
30	3	75	2 1/2"	PPR72303C	413,50	PPR72303CS	422,36	25,000
33	3	90	3"	PPR72333C	600,88	PPR72333CSA	613,99	28,100
36	3	90	3"	PPR72363C	623,38	PPR72363CS	629,05	29,000
39	3	90	3"	PPR72393C	645,89	PPR72393CSA	654,69	29,900
42	3	90	3"	PPR72423C	668,39	PPR72423CS	674,47	30,800
45	3	90	3"	PPR72453C	690,90	PPR72453CSA	697,18	31,700

INCLUIDO KIT DE MONTAJE

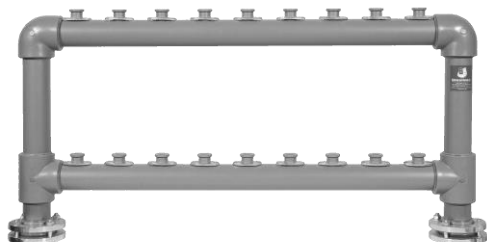
BATERÍAS POLIPROPILENO
MODELO CIRCUITO CERRADO 2 FILAS CON DOBLE ALIMENTACIÓN

N° CONTADORES	FILAS	Ø	PULGADAS	REF.	EUROS	PESO UNID.
18	2	75	2 1/2"	PPR91182	285,18	18,400
20	2	75	2 1/2"	PPR91202	295,76	19,300
22	2	75	2 1/2"	PPR91222	313,56	20,200
24	2	75	2 1/2"	PPR91242	324,14	21,100
26	2	75	2 1/2"	PPR91262	334,72	22,000
28	2	75	2 1/2"	PPR91282	345,30	22,900
30	2	75	2 1/2"	PPR91302	357,60	23,800

INCLUIDO KIT DE MONTAJE

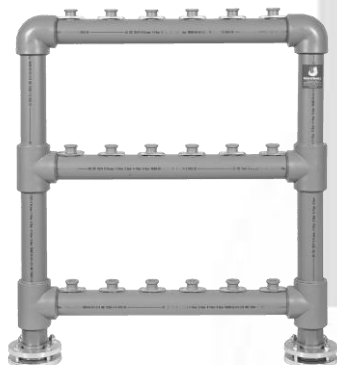
BATERÍAS POLIPROPILENO
MODELO CIRCUITO CERRADO 3 FILAS CON DOBLE ALIMENTACIÓN

N° CONTADORES	FILAS	Ø	PULGADAS	REF.	EUROS	PESO UNID.
18	3	75	2 1/2"	PPR92183	334,26	21,400
21	3	75	2 1/2"	PPR92213	350,13	22,300
24	3	75	2 1/2"	PPR92243	366,00	23,200
27	3	75	2 1/2"	PPR92273	381,87	24,100
30	3	75	2 1/2"	PPR92303	397,74	25,000
33	3	90	3"	PPR92333	591,18	27,900
36	3	90	3"	PPR92363	612,22	28,800
39	3	90	3"	PPR92393	634,98	29,700
42	3	90	3"	PPR92423	653,82	30,600
45	3	90	3"	PPR92453	677,05	31,500

INCLUIDO KIT DE MONTAJE

Revisión B

BATERÍAS VERSIÓN POLIPROPILENO 1 FILA

Nº CONTADORES	FILAS	REF.	EUROS	PESO UNID.
1	1	PPR10011	15,01	3,000
2	1	PPR10021	77,25	3,800
3	1	PPR10031	86,72	4,500
4	1	PPR10041	97,04	5,300
5	1	PPR10051	107,79	6,000
6	1	PPR10061	124,20	6,800

INCLUIDO KIT DE MONTAJE

BATERÍAS VERSIÓN POLIPROPILENO 2 FILAS

Nº CONTADORES	FILAS	REF.	EUROS	PESO UNID.
2	2	PPR10022	79,68	3,500
4	2	PPR10042	95,08	4,200
6	2	PPR10062	111,76	5,000
8	2	PPR10082	140,59	7,500
10	2	PPR10102	156,59	8,500
12	2	PPR10122	173,26	9,500

INCLUIDO KIT DE MONTAJE

Revisión B

BATERÍAS POLIPROPILENO CIRCUITO CERRADO SERIE ROSCADA 2 FILAS

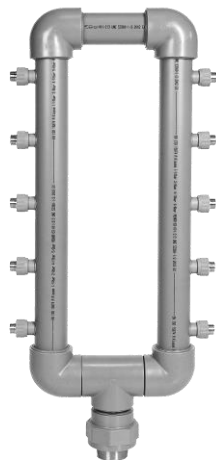

Nº CONTADORES	FILAS	Ø	R. ENTRADA	R. SALIDA	REF.	EUROS	PESO UNID.
6	2	63	2" H	3/4" M	PPR74062	188,43	3,900
8	2	63	2" H	3/4" M	PPR74082	207,66	4,800
10	2	75	2 1/2" H	3/4" M	PPR74102	276,91	9,000
12	2	75	2 1/2" H	3/4" M	PPR74122	298,65	9,800
14	2	75	2 1/2" H	3/4" M	PPR74142	320,38	10,600
16	2	75	2 1/2" H	3/4" M	PPR74162	343,04	11,400
18	2	75	2 1/2" H	3/4" M	PPR74182	364,78	12,200
20	2	75	2 1/2" H	3/4" M	PPR74202	386,51	13,000
22	2	75	2 1/2" H	3/4" M	PPR74222	409,17	13,800
24	2	75	2 1/2" H	3/4" M	PPR74242	432,68	14,600
26	2	75	2 1/2" H	3/4" M	PPR74262	454,41	15,400
28	2	75	2 1/2" H	3/4" M	PPR74282	477,07	16,200
30	2	75	2 1/2" H	3/4" M	PPR74302	506,22	17,000

INCLUIDO SOPORTE SUJECCIÓN

BATERÍAS VERSIÓN POLIPROPILENO ROSCADA 1 FILA



Nº CONTADORES	FILAS	Ø	R. ENTRADA	R. SALIDA	REF.	EUROS	PESO UNID.
3	1	63	2" H	3/4" M	PPR61031	86,82	1,800
4	1	63	2" H	3/4" M	PPR61041	94,72	2,200
5	1	63	2" H	3/4" M	PPR61051	102,76	3,000
6	1	63	2" H	3/4" M	PPR61061	112,37	3,900
7	1	63	2" H	3/4" M	PPR61071	120,13	4,300
8	1	75	2 1/2" H	3/4" M	PPR61081	159,43	5,100
9	1	75	2 1/2" H	3/4" M	PPR61091	167,98	6,700
10	1	75	2 1/2" H	3/4" M	PPR61101	177,46	7,500

PARA BATERÍAS CON OTRAS MEDIDAS CONSULTAR

BATERÍAS VERSIÓN POLIPROPILENO ROSCADA 2 FILAS



Nº CONTADORES	FILAS	Ø	R. ENTRADA	R. SALIDA	REF.	EUROS	PESO UNID.
4	2	63	2" H	3/4" M	PPR61042	93,02	2,600
6	2	63	2" H	3/4" M	PPR61062	105,66	3,400
8	2	75	2 1/2" H	3/4" M	PPR61082	146,15	5,900
10	2	75	2 1/2" H	3/4" M	PPR61102	161,79	8,300
12	2	75	2 1/2" H	3/4" M	PPR61122	177,49	9,100
14	2	75	2 1/2" H	3/4" M	PPR61142	190,54	9,900
16	2	75	2 1/2" H	3/4" M	PPR61162	202,18	10,700
18	2	75	2 1/2" H	3/4" M	PPR61182	215,60	11,500
20	2	75	2 1/2" H	3/4" M	PPR61202	229,50	12,300

PARA BATERÍAS CON OTRAS MEDIDAS CONSULTAR

BATERÍAS POLIPROPILENO CIRCUITO CERRADO 2 FILAS SERIE ROSCADA

Nº CONTADORES	FILAS	Ø	R.ENTRADA	R.SALIDA	REF.	EUROS	PESO UNID.
6	2	63	2" M	3/4" H	PPRE75062E	373,45	10,000
8	2	63	2" M	3/4" H	PPRE75082E	440,72	12,000
10	2	63	2" M	3/4" H	PPRE75102E	476,47	14,000
12	2	63	2" M	3/4" H	PPRE75122E	509,06	16,000
14	2	63	2" M	3/4" H	PPRE75142E	556,04	18,000
16	2	63	2" M	3/4" H	PPRE75162E	600,00	20,000

SOPORTES NO INCLUIDOS

Revisión B



BATERÍAS POLIPROPILENO 2 FILAS SERIE ROSCADA



Nº CONTADORES	FILAS	Ø	R.ENTRADA	R.SALIDA	REF.	EUROS	PESO UNID.
2	2	50	1 1/2" M	3/4" H	PPRE74022	198,14	9,000
4	2	50	1 1/2" M	3/4" H	PPRE74042	244,14	10,500
6	2	50	1 1/2" M	3/4" H	PPRE74062	277,78	12,000

SOPORTES NO INCLUIDOS

BATERÍAS POLIPROPILENO VERSIÓN 1 FILA SERIE ROSCADA



Nº CONTADORES	FILAS	Ø	R.ENTRADA	R.SALIDA	REF.	EUROS	PESO UNID.
2	1	40	1" M	3/4" H	PPRE63021	114,94	3,000
3	1	40	1" M	3/4" H	PPRE63031	134,68	4,000
4	1	40	1" M	3/4" H	PPRE63041	154,84	5,000

SOPORTES NO INCLUIDOS

Revisión B

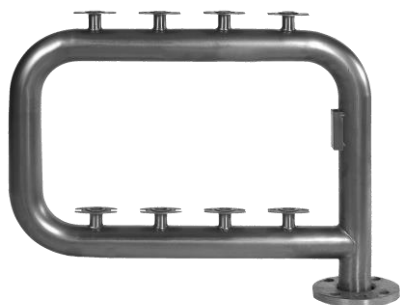
**BATERÍAS ACERO INOXIDABLE
MODELO CUADRO CIRCUITO CERRADO 2 FILAS**

N° CONTADORES	Ø	FILAS	PULGADAS	REF.	EUROS	PESO UNID.
4	63	2	2"	INOX20042	280,88	4,700
6	63	2	2"	INOX20062	308,58	5,200
8	63	2	2 1/2"	INOX20082	349,77	5,900
10	63	2	2 1/2"	INOX20102	385,93	6,700
12	63	2	2 1/2"	INOX20122	416,88	7,700
14	63	2	2 1/2"	INOX20142	447,86	8,100
16	63	2	2 1/2"	INOX20162	478,84	9,200
18	63	2	2 1/2"	INOX20182	495,63	9,700
20	63	2	2 1/2"	INOX20202	540,81	10,800
22	63	2	2 1/2"	INOX20222	571,80	11,500
24	63	2	2 1/2"	INOX20242	604,65	12,000
26	63	2	2 1/2"	INOX20262	635,64	12,700
28	63	2	2 1/2"	INOX20282	666,62	13,800
30	63	2	2 1/2"	INOX20302	697,60	14,300

INCLUIDO KIT DE MONTAJE

Revisión B

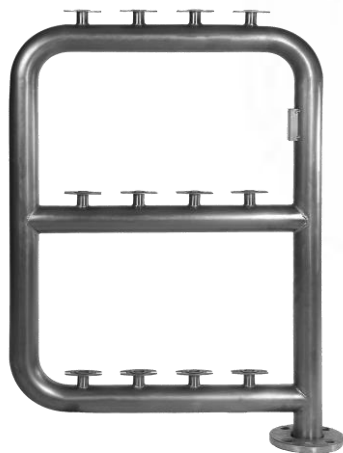
**BATERÍAS ACERO INOXIDABLE
MODELO CUADRO CIRCUITO CERRADO 3 FILAS**

N° CONTADORES	Ø	FILAS	PULGADAS	REF.	EUROS	PESO UNID.
6	63	3	2"	INOX30063	403,05	7,500
9	63	3	2 1/2"	INOX30093	445,17	8,200
12	63	3	2 1/2"	INOX30123	487,30	9,500
15	63	3	2 1/2"	INOX30153	529,54	10,500
18	63	3	2 1/2"	INOX30183	574,44	11,500
21	63	3	2 1/2"	INOX30213	617,98	12,800
24	63	3	2 1/2"	INOX30243	660,77	13,900
27	63	3	2 1/2"	INOX30273	703,47	15,000
30	63	3	2 1/2"	INOX30303	747,40	16,100
33	75	3	2 1/2"	INOX30333	956,49	21,300
36	75	3	2 1/2"	INOX30363	1.010,92	23,200
39	75	3	2 1/2"	INOX30393	1.088,90	25,100
42	75	3	2 1/2"	INOX30423	1.143,32	27,000
45	75	3	2 1/2"	INOX30453	1.221,31	28,800

OPCIONAL: En baterías con tubo Ø75 se pueden suministrar con brida roscada de 3"

INCLUIDO KIT DE MONTAJE

**BATERÍAS ACERO INOXIDABLE
 MODELO CIRCUITO CERRADO 2 FILAS SUPERIOR**

Nº CONTADORES	FILAS	Ø	PULGADAS	REF.	EUROS	PESO UNID.
4	2	63	2"	INOX20042S	294,92	4,700
6	2	63	2"	INOX20062S	324,01	5,200
8	2	63	2 1/2"	INOX20082S	367,26	5,900
10	2	63	2 1/2"	INOX20102S	405,23	6,700
12	2	63	2 1/2"	INOX20122S	437,72	7,700
14	2	63	2 1/2"	INOX20142S	470,25	8,100
16	2	63	2 1/2"	INOX20162S	502,78	9,200
18	2	63	2 1/2"	INOX20182S	520,41	9,700
20	2	63	2 1/2"	INOX20202S	567,85	10,800
22	2	63	2 1/2"	INOX20222S	600,39	11,500
24	2	63	2 1/2"	INOX20242S	634,88	12,000
26	2	63	2 1/2"	INOX20262S	667,42	12,700
28	2	63	2 1/2"	INOX20282S	699,95	13,800
30	2	63	2 1/2"	INOX20302S	732,48	14,300

INCLUIDO KIT DE MONTAJE

**BATERÍAS ACERO INOXIDABLE
 MODELO CIRCUITO CERRADO 3 FILAS SUPERIOR**

Nº CONTADORES	FILAS	Ø	PULGADAS	REF.	EUROS	PESO UNID.
6	3	63	2"	INOX30063S	423,20	7,500
9	3	63	2 1/2"	INOX30093S	467,43	8,200
12	3	63	2 1/2"	INOX30123S	511,67	9,500
15	3	63	2 1/2"	INOX30153S	556,02	10,500
18	3	63	2 1/2"	INOX30183S	603,16	11,500
21	3	63	2 1/2"	INOX30213S	648,88	12,800
24	3	63	2 1/2"	INOX30243S	693,81	13,900
27	3	63	2 1/2"	INOX30273S	738,64	15,000
30	3	63	2 1/2"	INOX30303S	784,77	16,100
33	3	75	2 1/2"	INOX30333S	1.004,31	21,300
36	3	75	2 1/2"	INOX30363S	1.061,47	23,200
39	3	75	2 1/2"	INOX30393S	1.143,35	25,100
42	3	75	2 1/2"	INOX30423S	1.200,49	27,000
45	3	75	2 1/2"	INOX30453S	1.282,38	28,800

OPCIONAL: En baterías con tubo Ø75 se pueden suministrar con brida roscada de 3"

INCLUIDO KIT DE MONTAJE

Revisión B

**BATERÍAS ACERO INOXIDABLE
MODELO CIRCUITO CERRADO 2 FILAS LATERAL INFERIOR Y SUPERIOR**



N° CONTADORES	FILAS	Ø	PULGADAS	REF. INFERIOR	EUROS	REF. SUPERIOR	EUROS	PESO UNID.
4	2	63	2"	INOX20042LI	300,54	INOX20042LS	300,54	4,700
6	2	63	2"	INOX20062LI	330,18	INOX20062LS	330,18	5,200
8	2	63	2 1/2"	INOX20082LI	374,25	INOX20082LS	374,25	5,900
10	2	63	2 1/2"	INOX20102LI	412,95	INOX20102LS	412,95	6,700
12	2	63	2 1/2"	INOX20122LI	446,06	INOX20122LS	446,06	7,700
14	2	63	2 1/2"	INOX20142LI	479,21	INOX20142LS	479,21	8,100
16	2	63	2 1/2"	INOX20162LI	512,36	INOX20162LS	512,36	9,200
18	2	63	2 1/2"	INOX20182LI	530,32	INOX20182LS	530,32	9,700
20	2	63	2 1/2"	INOX20202LI	578,67	INOX20202LS	578,67	10,800
22	2	63	2 1/2"	INOX20222LI	611,83	INOX20222LS	611,83	11,500
24	2	63	2 1/2"	INOX20242LI	646,98	INOX20242LS	646,98	12,000
26	2	63	2 1/2"	INOX20262LI	680,13	INOX20262LS	680,13	12,700
28	2	63	2 1/2"	INOX20282LI	713,28	INOX20282LS	713,28	13,800
30	2	63	2 1/2"	INOX20302LI	746,43	INOX20302LS	746,43	14,300

INCLUIDO KIT DE MONTAJE

**BATERÍAS ACERO INOXIDABLE
MODELO CIRCUITO CERRADO 3 FILAS LATERAL INFERIOR Y SUPERIOR**

Revisión B



N° CONTADORES	FILAS	Ø	PULGADAS	REF. INFERIOR	EUROS	REF. SUPERIOR	EUROS	PESO UNID.
6	3	63	2"	INOX30063LI	431,26	INOX30063LS	431,26	7,500
9	3	63	2 1/2"	INOX30093LI	476,33	INOX30093LS	476,33	8,200
12	3	63	2 1/2"	INOX30123LI	521,41	INOX30123LS	521,41	9,500
15	3	63	2 1/2"	INOX30153LI	566,61	INOX30153LS	566,61	10,500
18	3	63	2 1/2"	INOX30183LI	614,65	INOX30183LS	614,65	11,500
21	3	63	2 1/2"	INOX30213LI	661,24	INOX30213LS	661,24	12,800
24	3	63	2 1/2"	INOX30243LI	707,02	INOX30243LS	707,02	13,900
27	3	63	2 1/2"	INOX30273LI	752,71	INOX30273LS	752,71	15,000
30	3	63	2 1/2"	INOX30303LI	799,72	INOX30303LS	799,72	16,100
33	3	75	2 1/2"	INOX30333LI	1.023,44	INOX30333LS	1.023,44	21,300
36	3	75	2 1/2"	INOX30363LI	1.081,68	INOX30363LS	1.081,68	23,200
39	3	75	2 1/2"	INOX30393LI	1.165,12	INOX30393LS	1.165,12	25,100
42	3	75	2 1/2"	INOX30423LI	1.223,35	INOX30423LS	1.223,35	27,000
45	3	75	2 1/2"	INOX30453LI	1.306,80	INOX30453LS	1.306,80	28,800

OPCIONAL: En baterías con tubo Ø75 se pueden suministrar con brida roscada de 3"

INCLUIDO KIT DE MONTAJE

**BATERÍAS ACERO INOXIDABLE
MODELO CIRCUITO CERRADO 2 FILAS CENTRAL Y CENTRAL SUPERIOR Y/O ACODADA**



N° CONTADORES	FILAS	Ø	PULGADAS	REF. CENTRAL	EUROS	REF. CENTRAL SUPERIOR	EUROS	PESO UNID.
4	2	63	2"	INOX20042C	308,97	INOX20042CS	323,01	4,700
6	2	63	2"	INOX20062C	339,44	INOX20062CSA	367,21	5,200
8	2	63	2 1/2"	INOX20082C	384,75	INOX20082CS	391,74	5,900
10	2	63	2 1/2"	INOX20102C	424,52	INOX20102CSA	447,68	6,700
12	2	63	2 1/2"	INOX20122C	458,57	INOX20122CS	454,40	7,700
14	2	63	2 1/2"	INOX20142C	492,65	INOX20142CSA	515,04	8,100
16	2	63	2 1/2"	INOX20162C	526,72	INOX20162CS	536,30	9,200
18	2	63	2 1/2"	INOX20182C	545,19	INOX20182CSA	555,11	9,700
20	2	63	2 1/2"	INOX20202C	594,89	INOX20202CS	605,71	10,800
22	2	63	2 1/2"	INOX20222C	628,98	INOX20222CSA	640,42	11,500
24	2	63	2 1/2"	INOX20242C	665,12	INOX20242CS	677,21	12,000
26	2	63	2 1/2"	INOX20262C	699,20	INOX20262CSA	711,92	12,700
28	2	63	2 1/2"	INOX20282C	733,28	INOX20282CS	746,61	13,800
30	2	63	2 1/2"	INOX20302C	767,36	INOX20302CSA	781,31	14,300

INCLUIDO KIT DE MONTAJE

**BATERÍAS ACERO INOXIDABLE
MODELO CIRCUITO CERRADO 3 FILAS CENTRAL Y CENTRAL SUPERIOR Y/O ACODADA**



N° CONTADORES	FILAS	Ø	PULGADAS	REF. CENTRAL	EUROS	REF. CENTRAL SUPERIOR	EUROS	PESO UNID.
6	3	63	2"	INOX30063C	443,36	INOX30063CS	451,42	7,500
9	3	63	2 1/2"	INOX30093C	489,69	INOX30093CSA	507,49	8,200
12	3	63	2 1/2"	INOX30123C	536,03	INOX30123CS	545,78	9,500
15	3	63	2 1/2"	INOX30153C	582,49	INOX30153CSA	593,08	10,500
18	3	63	2 1/2"	INOX30183C	631,88	INOX30183CS	643,37	11,500
21	3	63	2 1/2"	INOX30213C	679,78	INOX30213CSA	692,14	12,800
24	3	63	2 1/2"	INOX30243C	726,85	INOX30243CS	740,06	13,900
27	3	63	2 1/2"	INOX30273C	773,82	INOX30273CSA	787,89	15,000
30	3	63	2 1/2"	INOX30303C	822,14	INOX30303CS	837,09	16,100
33	3	75	2 1/2"	INOX30333C	1.052,14	INOX30333CSA	1.071,27	21,300
36	3	75	2 1/2"	INOX30363C	1.112,01	INOX30363CS	1.132,23	23,200
39	3	75	2 1/2"	INOX30393C	1.197,79	INOX30393CSA	1.219,57	25,100
42	3	75	2 1/2"	INOX30423C	1.257,65	INOX30423CS	1.280,52	27,000
45	3	75	2 1/2"	INOX30453C	1.343,44	INOX30453CSA	1.367,87	28,800

OPCIONAL: En baterías con tubo Ø75 se pueden suministrar con brida roscada de 3"

INCLUIDO KIT DE MONTAJE

Revisión B

BATERÍAS ACERO INOXIDABLE
MODELO CUADRO CIRCUITO CERRADO 2 FILAS CON DOBLE ALIMENTACIÓN

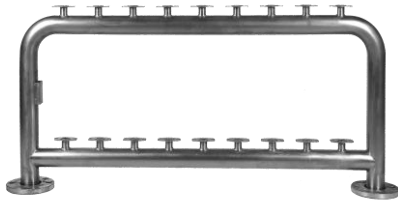

Nº CONTADORES	Ø	FILAS	PULGADAS	REF.	EUROS	PESO UNID.
18	63	2	2 1/2"	INOX40182	545,92	10,500
20	63	2	2 1/2"	INOX40202	576,22	11,200
22	63	2	2 1/2"	INOX40222	606,38	11,900
24	63	2	2 1/2"	INOX40242	636,50	12,700
26	63	2	2 1/2"	INOX40262	666,69	13,400
28	63	2	2 1/2"	INOX40282	696,81	14,100
30	63	2	2 1/2"	INOX40302	727,04	14,800

INCLUIDO KIT DE MONTAJE

BATERÍAS ACERO INOXIDABLE
MODELO CUADRO CIRCUITO CERRADO 3 FILAS CON DOBLE ALIMENTACIÓN

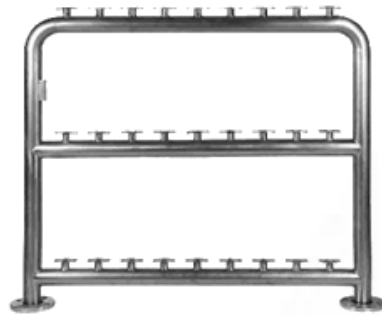

Nº CONTADORES	Ø	FILAS	PULGADAS	REF.	EUROS	PESO UNID.
18	63	3	2 1/2"	INOX50183	629,61	12,900
21	63	3	2 1/2"	INOX50213	670,34	13,900
24	63	3	2 1/2"	INOX50243	712,16	14,920
27	63	3	2 1/2"	INOX50273	769,69	15,930
30	63	3	2 1/2"	INOX50303	816,65	16,940
33	75	3	2 1/2"	INOX50333	987,90	22,100
36	75	3	2 1/2"	INOX50363	1.042,38	23,900
39	75	3	2 1/2"	INOX50393	1.120,36	25,700
42	75	3	2 1/2"	INOX50423	1.174,84	26,900
45	75	3	2 1/2"	INOX50453	1.254,17	28,400

OPCIONAL: En baterías con tubo Ø75 se pueden suministrar con brida roscada de 3"

INCLUIDO KIT DE MONTAJE

Revisión B

BATERÍAS VERSIÓN ACERO INOXIDABLE 1 FILA



Nº CONTADORES	FILAS	REF.	EUROS	PESO UNID.
1	1	INOX10011	37,22	0,350
2	1	INOX10021	143,91	1,300
3	1	INOX10031	172,18	1,750
4	1	INOX10041	199,89	2,200
5	1	INOX10051	243,43	2,650

INCLUIDO KIT DE MONTAJE

BATERÍAS VERSIÓN ACERO INOXIDABLE 2 FILAS



Nº CONTADORES	FILAS	REF.	EUROS	PESO UNID.
2	2	INOX10022	156,97	0,900
4	2	INOX10042	198,26	1,750
6	2	INOX10062	249,77	2,600
8	2	INOX10082	308,34	4,450
10	2	INOX10102	386,94	4,750

INCLUIDO KIT DE MONTAJE

BATERÍAS VERSIÓN ACERO INOXIDABLE HORIZONTAL



Nº CONTADORES	REF.	EUROS	PESO UNID.
2	INOX12002	124,66	1,200
3	INOX12003	139,06	1,650

INCLUIDO KIT DE MONTAJE

BATERÍAS VERSIÓN ACERO INOXIDABLE HORIZONTAL CON CODO



Nº CONTADORES	REF.	EUROS	PESO UNID.
2	INOX11002	136,41	1,400
3	INOX11003	150,54	1,800

INCLUIDO KIT DE MONTAJE

Revisión B

BATERÍAS POLIETILENO VERSIÓN

(COLECTOR DE UNA SOLA PIEZA)



Nº CONTADORES	FILAS	Ø	R. ENTRADA	R. SALIDA	REF.	EUROS	PESO UNID.
3	1	63	2" M	3/4" M	PE61031	46,78	0,150
4	1	63	2" M	3/4" M	PE61041	51,73	0,182
5	1	63	2" M	3/4" M	PE61051	54,23	0,212
6	1	63	2" M	3/4" M	PE61061	57,74	0,244
7	1	63	2" M	3/4" M	PE61071	63,73	0,276
8	1	63	2" M	3/4" M	PE61081	67,59	0,308
9	1	63	2" M	3/4" M	PE61091	73,74	0,340
10	1	63	2" M	3/4" M	PE61101	77,42	0,372

PARA BATERÍAS CON OTRAS MEDIDAS CONSULTAR

BATERÍAS POLIETILENO ROSCADAS MOD. TREVI

(TUBO VERTICAL Y SALIDAS DE UNA SOLA PIEZA)



Nº CONTADORES	FILAS	Ø	R. ENTRADA	R. SALIDA	REF.	EUROS	PESO UNID.
6	2	63	2" M	3/4" M	PE74062	102,50	0,201
8	2	63	2" M	3/4" M	PE74082	117,41	0,224
10	2	63	2" M	3/4" M	PE74102	117,41	0,256
12	2	63	2" M	3/4" M	PE74122	124,42	0,288
14	2	63	2" M	3/4" M	PE74142	136,41	0,320
16	2	63	2" M	3/4" M	PE74162	151,97	0,352
18	2	63	2" M	3/4" M	PE74182	162,97	0,382

PARA BATERÍAS CON OTRAS MEDIDAS CONSULTAR

Revisión B

AMPLIACIÓN DE BATERÍA



AMPLIACIÓN DE BATERÍA A/G

REF.	EUROS	UNID. DE EMBALAJE	PESO UNID.
1010001	49,96	1	1,000

AMPLIACIÓN DE BATERÍA PPR

REF.	EUROS	UNID. DE EMBALAJE	PESO UNID.
1010010	38,60	1	0,350

AMPLIACIÓN DE BATERÍA A/INOX

REF.	EUROS	UNID. DE EMBALAJE	PESO UNID.
1010020	86,27	1	0,450

CAÑO LIBRE COMPROBACIÓN EN PPR



3/4" x 3/4" PPR LONG. 110

REF.	EUROS	UNID. DE EMBALAJE	PESO UNID.
1010107	3,40	10	0,020

7/8" x 3/4" PPR LONG. 115

REF.	EUROS	UNID. DE EMBALAJE	PESO UNID.
1010109	3,85	10	0,025

1" x 1" PPR LONG. 130

REF.	EUROS	UNID. DE EMBALAJE	PESO UNID.
1010108	5,04	10	0,030

CAÑO SUPLETORIO CIEGO



3/4" x 3/4" LONG. 115 COLOR AZUL

REF.	EUROS	UNID. DE EMBALAJE	PESO UNID.
1010110	8,81	10	0,068

1" x 1" LONG. 190 COLOR ROJO

REF.	EUROS	UNID. DE EMBALAJE	PESO UNID.
1010111	11,72	10	0,160

* Hasta fin de existencias

Revisión B

BRIDA CIEGA ZINCADA CON TORNILLOS Y JUNTA

	REF.	EUROS	UNID. DE EMBALAJE	PESO UNID.
	1010201	4,10	10	0,216

BRIDA CIEGA A/INOX CON TORNILLOS Y JUNTA

	REF.	EUROS	UNID. DE EMBALAJE	PESO UNID.
	1010204	5,95	10	0,144

BRIDA CIEGA ANTIFRAUDE

SISTEMA PATENTADO

	REF.	EUROS	UNID. DE EMBALAJE	PESO UNID.
	1010209	21,76	10	0,526

TAPONES ANTIFRAUDE NO INCLUIDOS

CONTRABRIDA MACHO CON TORNILLOS Y JUNTA

	REF.	EUROS	UNID. DE EMBALAJE	PESO UNID.
	1010211	5,85	10	0,236

Revisión B

ABRAZADERAS DE REPARACIÓN ACERO INOXIDABLE CON TOMA

ABRAZADERA DE REPARACIÓN ACERO INOX. Ø63 CON TOMA

REF.	EUROS	UNID. DE EMBALAJE	PESO UNID.
380001	58,63	1	0,450

ABRAZADERA DE REPARACIÓN ACERO INOX. Ø75 CON TOMA

REF.	EUROS	UNID. DE EMBALAJE	PESO UNID.
380002	59,93	1	0,550

ABRAZADERA DE REPARACIÓN ACERO INOX. Ø90 CON TOMA

REF.	EUROS	UNID. DE EMBALAJE	PESO UNID.
380003	61,11	1	0,650



Revisión B

SOPORTE BATERÍA ACERO ZINCADO

SOPORTE BATERÍA A/G Ø10

REF.	EUROS	UNID. DE EMBALAJE	PESO UNID.
1010011	1,83	2	0,150



SOPORTE BATERÍA A/G Ø12

REF.	EUROS	UNID. DE EMBALAJE	PESO UNID.
1010012	3,50	2	0,200

SOPORTE BATERÍA ACERO ZINCADO

SOPORTE BATERÍA PPR-PE Ø DE TUBO 63

REF.	EUROS	UNID. DE EMBALAJE	PESO UNID.
1010014	1,83	2	0,185



SOPORTE BATERÍA PPR-PE Ø DE TUBO 75

REF.	EUROS	UNID. DE EMBALAJE	PESO UNID.
1010015	3,52	2	0,210

SOPORTE BATERÍA PPR-PE Ø DE TUBO 90

REF.	EUROS	UNID. DE EMBALAJE	PESO UNID.
1010016	3,53	2	0,210

SOPORTE BATERÍA A/INOX. AISI-304

SOPORTE BATERÍA A/INOX PARA Ø DE TUBO 63

REF.	EUROS	UNID. DE EMBALAJE	PESO UNID.
1010017	7,59	2	0,140



SOPORTE BATERÍA A/INOX PARA Ø DE TUBO 75

REF.	EUROS	UNID. DE EMBALAJE	PESO UNID.
1010018	8,84	2	0,153

Revisión B

PLACAS DE CLASIFICACIÓN ESTÁNDAR



4x2 a 30x2	REF.	EUROS	6x3 a 60x3	REF.	EUROS	UNID.
4x2	01011042	5,99	6x3	01011063	6,98	1
6x2	01011062	6,73	9x3	01011093	7,94	1
8x2	01011082	7,49	12x3	01011123	8,90	1
10x2	01011102	8,24	15x3	01011153	9,86	1
12x2	01011122	8,98	18x3	01011183	10,81	1
14x2	01011142	9,74	21x3	01011213	12,83	1
16x2	01011162	10,49	24x3	01011243	13,72	1
18x2	01011182	11,23	27x3	01011273	14,68	1
20x2	01011202	12,24	30x3	01011303	16,13	1
22x2	01011222	12,99	33x3	01011333	17,99	1
24x2	01011242	13,74	36x3	01011363	19,32	1
26x2	01011262	14,99	39x3	01011393	20,32	1
28x2	01011282	15,74	42x3	01011423	21,96	1
30x2	01011302	16,68	45x3	01011453	23,68	1
			48x3	01011483	25,95	1
			51x3	01011513	28,14	1
			54x3	01011543	28,90	1
			57x3	01011573	31,18	1
			60x3	01011603	34,31	1

PLACAS DE CLASIFICACIÓN VERTICAL



1x1 a 6x1	REF.	EUROS	2x2 a 12x2	REF.	EUROS	UNID.
4x2	01011061	6,84	2x2	01012022	6,01	1
			4x2	01012042	6,18	1
			6x2	01012062	7,00	1
			8x2	01012082	7,83	1
			10x2	01012102	8,66	1
			22x2	01012122	9,49	1

CONEXIONES FLEXIBLES



MEDIDA	LONGITUD	ROSCA	MATERIAL	REF.	EUROS	UNID.	PESO UNID.
						EMBALAJE	
3/4"	400	M-H	GALVANIZADO(*)	1010340	8,02	10	0,300
1"	300	M-H	GALVANIZADO(*)	1010430	11,71	10	0,300
1"	500	M-H	GALVANIZADO(*)	1010450	13,96	10	0,400
3/4"	300	M-H	INOXIDABLE	1010530	9,61	10	0,250
3/4"	400	M-H	INOXIDABLE	1010540	10,39	10	0,300
3/4"	500	M-H	INOXIDABLE	1010550	11,31	10	0,350
3/4"	600	M-H	INOXIDABLE	1010560	12,17	10	0,400
1"	300	M-H	INOXIDABLE	1010630	16,26	10	0,300
1"	400	M-H	INOXIDABLE	1010640	16,75	10	0,350
1"	500	M-H	INOXIDABLE	1010650	18,51	10	0,400
1"	600	M-H	INOXIDABLE	1010660	19,74	10	0,450

(*) Hasta fin de existencias en conexiones flexibles en acero galvanizado.

JUNTAS PLANAS EPDM PARA BRIDAS PN6 – PN10

JUNTA PLANA BRIDA PN 10 1 1/4" AG-INOX 80x44x3

REF.	EUROS	UNID. DE EMBALAJE	PESO UNID.
1010940	0,65	5	0,018

JUNTA PLANA BRIDA PN 10 1 1/2" AG-INOX 93x49x3

REF.	EUROS	UNID. DE EMBALAJE	PESO UNID.
1010941	0,78	5	0,024

JUNTA PLANA BRIDA PN 10 2" AG-INOX 104x65x3

REF.	EUROS	UNID. DE EMBALAJE	PESO UNID.
1010942	0,89	5	0,031

JUNTA PLANA BRIDA PN 10 2 1/2" AG-INOX 127x76x3

REF.	EUROS	UNID. DE EMBALAJE	PESO UNID.
1010943	1,70	5	0,037

JUNTA PLANA BRIDA PN 10 3" AG-INOX 143x90x3

REF.	EUROS	UNID. DE EMBALAJE	PESO UNID.
1010944	1,80	5	0,043



JUNTA PLANA BRIDA PN 6 2" PPR-PE 93x49x3

REF.	EUROS	UNID. DE EMBALAJE	PESO UNID.
1010941	0,78	5	0,031

JUNTA PLANA BRIDA PN 6 2 1/2" PPR-PE 104x65x3

REF.	EUROS	UNID. DE EMBALAJE	PESO UNID.
1010942	0,89	5	0,037

JUNTA PLANA BRIDA PN 6 3" PPR-PE 127x76x3

REF.	EUROS	UNID. DE EMBALAJE	PESO UNID.
1010943	1,70	5	0,043



Revisión B



JUNTA PLANA BRIDA CIEGA 44x3

REF.	EUROS	UNID. DE EMBALAJE	PESO UNID.
1036001	0,38	5	0,006



JUNTA PLANA CONTRABRIDA 43x20x3

REF.	EUROS	UNID. DE EMBALAJE	PESO UNID.
1035110	0,50	5	0,009



JUNTA PLANA 3/4" PARA CONEXIÓN FLEXIBLE

REF.	EUROS	UNID. DE EMBALAJE	PESO UNID.
1035111	0,19	20	0,006

JUNTA PLANA 1" PARA CONEXIÓN FLEXIBLE

REF.	EUROS	UNID. DE EMBALAJE	PESO UNID.
1035161	0,27	20	0,006

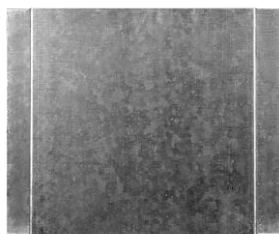
BANCADAS PARA GRUPOS DE PRESIÓN

MEDIDAS	REF.	EUROS	UNID. EMBALAJE	PESO UNID.
40x38	160001	37,63	1	5,100
70x38	160006	86,27	1	8,900
80x70	160011	122,69	1	11,700
80x38	160013	99,09	1	10,800
90x38	160007	106,15	1	12,900
90x50	160008	122,69	1	14,600
90x70	160012	139,19	1	17,300
95x65	160019	229,80	1	20,200

COLECTOR SIN SALIDA DE MANÓMETRO ZINCADOS

PULGADAS	REF.	EUROS	UNID. EMBALAJE	PESO UNID.
1 ½" 1 ¼"	161001	88,25	1	1,600
2" 1 ½"	161002	95,55	1	2,100
2 ½" 2"	161003	116,41	1	4,500
3" 2 ½"	161004	138,51	1	5,200

COLECTOR CON SALIDA DE MANÓMETRO ZINCADOS

PULGADAS	REF.	EUROS	UNID. EMBALAJE	PESO UNID.
1 ½" 1 ¼"	162001	87,48	1	1,650
2" 1 ½"	162002	95,45	1	2,500
2 ½" 2"	162003	114,46	1	4,800
3" 2 ½"	162004	134,10	1	5,450

COLECTOR 3 VÍAS PARA BATERÍA DE CONTADORES

BRIDA	ROSCA MACHO	REF.	EUROS	PESO UNID.
1 1/2"	1 1/2"	165002	59,15	2,700
2"	2"	165003	65,22	3,700
2 1/2"	2 1/2"	165004	75,40	5,300
3"	3"	165005	87,32	6,600

INCLUIDO KIT DE MONTAJE

TORNILLERÍA
TORNILLO M-12x65 ZINCADO C/T

REF.	EUROS	UNID. DE EMBALAJE	PESO UNID.
202007	0,99	5	0,054

TORNILLO M-12x80 ZINCADO C/T

REF.	EUROS	UNID. DE EMBALAJE	PESO UNID.
202018	1,23	5	0,058

TORNILLO M-16x55 ZINCADO C/T

REF.	EUROS	UNID. DE EMBALAJE	PESO UNID.
202008	1,82	5	0,087

TORNILLO M-16x60 ZINCADO C/T

REF.	EUROS	UNID. DE EMBALAJE	PESO UNID.
202009	1,85	5	0,098

TORNILLO M-16x70 ZINCADO C/T

REF.	EUROS	UNID. DE EMBALAJE	PESO UNID.
202010	1,87	5	0,116

TORNILLO M-16x80 ZINCADO C/T

REF.	EUROS	UNID. DE EMBALAJE	PESO UNID.
202011	1,91	5	0,128

TORNILLO M-20x70 ZINCADO C/T

REF.	EUROS	UNID. DE EMBALAJE	PESO UNID.
202015	2,05	10	0,115

TORNILLO M-20x80 ZINCADO C/T

REF.	EUROS	UNID. DE EMBALAJE	PESO UNID.
202017	3,53	10	0,124

ESPÁRRAGO M-16x60 ZINCADO C/T

REF.	EUROS	UNID. DE EMBALAJE	PESO UNID.
01611107	0,82	10	0,080

ESPÁRRAGO M-16x70 ZINCADO C/T

REF.	EUROS	UNID. DE EMBALAJE	PESO UNID.
01611101	0,91	10	0,094

ESPÁRRAGO M-16x80 ZINCADO C/T

REF.	EUROS	UNID. DE EMBALAJE	PESO UNID.
01611108	1,00	10	0,100

ESPÁRRAGO M-16x90 ZINCADO C/T

REF.	EUROS	UNID. DE EMBALAJE	PESO UNID.
01611109	1,09	10	0,110

Revisión B

NOTAS

Revisión B



VÁLVULAS ASIEN TO

SERIE BS BS

Revisión B
23/01



Revisión B

ÍNDICE

PAG. 39-43.....VÁLVULAS SERIE BS

PAG. 44-47..... ACCESORIOS VÁLVULAS SERIE BS

PAG. 48..... TORNILLERIA VÁLVULAS EMBRIDADAS



Revisión B

VÁLVULAS ENTRADA SERIE BS PARA CONTADORES Ø 13, 15 Y 20



ENTRADA FIJA DN 13-15

DISPOSITIVO ANTIRRETORNO	SI	NO	REF.	EUROS	UNID. DE EMBALAJE	PESO UNID.
	<input checked="" type="checkbox"/>	<input type="checkbox"/>	100001	15,24	30	0,400

ENTRADA FIJA DN 20

DISPOSITIVO ANTIRRETORNO	SI	NO	REF.	EUROS	UNID. DE EMBALAJE	PESO UNID.
	<input checked="" type="checkbox"/>	<input type="checkbox"/>	100011	21,67	30	0,600

OPCIÓN DE MANETA DE LATÓN. CONSULTAR.



ENTRADA ORIENTABLE DN 13-15

DISPOSITIVO ANTIRRETORNO	SI	NO	REF.	EUROS	UNID. DE EMBALAJE	PESO UNID.
	<input checked="" type="checkbox"/>	<input type="checkbox"/>	101001	16,14	30	0,500

ENTRADA ORIENTABLE DN 20

DISPOSITIVO ANTIRRETORNO	SI	NO	REF.	EUROS	UNID. DE EMBALAJE	PESO UNID.
	<input checked="" type="checkbox"/>	<input type="checkbox"/>	101011	22,02	30	0,700

OPCIÓN DE MANETA DE LATÓN. CONSULTAR.



ENTRADA FIJA Y ANTIFRAUDE DN 13-15

DISPOSITIVO ANTIRRETORNO	SI	NO	REF.	EUROS	UNID. DE EMBALAJE	PESO UNID.
	<input checked="" type="checkbox"/>	<input type="checkbox"/>	100002	19,16	30	0,400

ENTRADA FIJA Y ANTIFRAUDE DN 20

DISPOSITIVO ANTIRRETORNO	SI	NO	REF.	EUROS	UNID. DE EMBALAJE	PESO UNID.
	<input checked="" type="checkbox"/>	<input type="checkbox"/>	100022	22,47	30	0,450



ENTRADA ORIENTABLE Y ANTIFRAUDE DN 13-15

DISPOSITIVO ANTIRRETORNO	SI	NO	REF.	EUROS	UNID. DE EMBALAJE	PESO UNID.
	<input checked="" type="checkbox"/>	<input type="checkbox"/>	101002	19,88	30	0,400

ENTRADA ORIENTABLE Y ANTIFRAUDE DN 20

DISPOSITIVO ANTIRRETORNO	SI	NO	REF.	EUROS	UNID. DE EMBALAJE	PESO UNID.
	<input checked="" type="checkbox"/>	<input type="checkbox"/>	101012	27,92	30	0,450

INCLUIDO EL MANGUITO DE CONEXIÓN AL CONTADOR
FILTROS PARA VÁLVULAS BS PÁG. 46

Revisión B

VÁLVULAS ENTRADA SERIE BS PARA CONTADORES Ø 13, 15 Y 20



ENTRADA DN 13-15

DISPOSITIVO ANTIRRETORNO	SI	NO	REF.	EUROS	UNID. DE EMBALAJE	PESO UNID.
	<input checked="" type="checkbox"/>	<input type="checkbox"/>	102001	11,64	50	0,350

ENTRADA DN 20

DISPOSITIVO ANTIRRETORNO	SI	NO	REF.	EUROS	UNID. DE EMBALAJE	PESO UNID.
	<input checked="" type="checkbox"/>	<input type="checkbox"/>	102011	19,61	30	0,400

OPCIÓN DE MANETA DE LATÓN. CONSULTAR.



ENTRADA ANTIFRAUDE DN 13-15

DISPOSITIVO ANTIRRETORNO	SI	NO	REF.	EUROS	UNID. DE EMBALAJE	PESO UNID.
	<input checked="" type="checkbox"/>	<input type="checkbox"/>	102002	12,44	30	0,350

ENTRADA ANTIFRAUDE DN 20

DISPOSITIVO ANTIRRETORNO	SI	NO	REF.	EUROS	UNID. DE EMBALAJE	PESO UNID.
	<input checked="" type="checkbox"/>	<input type="checkbox"/>	102012	20,82	30	0,400

Revisión B



ENTRADA CON CONEXIÓN A P.E. EXT 25 DN 13-15

DISPOSITIVO ANTIRRETORNO	SI	NO	REF.	EUROS	UNID. DE EMBALAJE	PESO UNID.
	<input checked="" type="checkbox"/>	<input type="checkbox"/>	102003	19,55	50	0,500

ENTRADA CON CONEXIÓN A P.E. EXT 32 DN 20

DISPOSITIVO ANTIRRETORNO	SI	NO	REF.	EUROS	UNID. DE EMBALAJE	PESO UNID.
	<input checked="" type="checkbox"/>	<input type="checkbox"/>	102013	25,37	30	0,700

OPCIÓN DE MANETA DE LATÓN. CONSULTAR.



ENTRADA ANTIFRAUDE Y CONEXIÓN A P.E. EXT 25 DN 13-15

DISPOSITIVO ANTIRRETORNO	SI	NO	REF.	EUROS	UNID. DE EMBALAJE	PESO UNID.
	<input checked="" type="checkbox"/>	<input type="checkbox"/>	102004	21,45	50	0,350

ENTRADA ANTIFRAUDE Y CONEXIÓN A P.E. EXT 32 DN 20

DISPOSITIVO ANTIRRETORNO	SI	NO	REF.	EUROS	UNID. DE EMBALAJE	PESO UNID.
	<input checked="" type="checkbox"/>	<input type="checkbox"/>	102014	27,27	30	0,600

INCLUIDO EL MANGUITO DE CONEXIÓN AL CONTADOR
FILTROS PARA VÁLVULAS BS PÁG. 46

VÁLVULAS SALIDA SERIE BS PARA CONTADORES Ø 13, 15 Y 20



SALIDA DN 13-15

DISPOSITIVO ANTIRRETORNO	SI	NO	REF.	EUROS	UNID. DE EMBALAJE	PESO UNID.
	<input checked="" type="checkbox"/>	<input type="checkbox"/>	103001	11,02	50	0,300

SALIDA DN 20

DISPOSITIVO ANTIRRETORNO	SI	NO	REF.	EUROS	UNID. DE EMBALAJE	PESO UNID.
	<input checked="" type="checkbox"/>	<input type="checkbox"/>	103011	18,95	40	0,550

OPCIÓN DE MANETA DE LATÓN. CONSULTAR.



SALIDA DN 13-15

DISPOSITIVO ANTIRRETORNO	SI	NO	REF.	EUROS	UNID. DE EMBALAJE	PESO UNID.
	<input checked="" type="checkbox"/>	<input type="checkbox"/>	104001	11,80	50	0,350

SALIDA DN 20

DISPOSITIVO ANTIRRETORNO	SI	NO	REF.	EUROS	UNID. DE EMBALAJE	PESO UNID.
	<input checked="" type="checkbox"/>	<input type="checkbox"/>	104011	19,85	40	0,400

OPCIÓN DE MANETA DE LATÓN. CONSULTAR.



SALIDA CON PURGA DN 13-15

DISPOSITIVO ANTIRRETORNO	SI	NO	REF.	EUROS	UNID. DE EMBALAJE	PESO UNID.
	<input checked="" type="checkbox"/>	<input type="checkbox"/>	103006	19,86	40	0,550

SALIDA CON PURGA DN 20

DISPOSITIVO ANTIRRETORNO	SI	NO	REF.	EUROS	UNID. DE EMBALAJE	PESO UNID.
	<input checked="" type="checkbox"/>	<input type="checkbox"/>	103016	26,20	25	0,800

OPCIÓN DE MANETA DE LATÓN. CONSULTAR.



SALIDA ANTIFRAUDE DN 13-15

DISPOSITIVO ANTIRRETORNO	SI	NO	REF.	EUROS	UNID. DE EMBALAJE	PESO UNID.
	<input checked="" type="checkbox"/>	<input type="checkbox"/>	104002	12,90	50	0,300

SALIDA ANTIFRAUDE DN 20

DISPOSITIVO ANTIRRETORNO	SI	NO	REF.	EUROS	UNID. DE EMBALAJE	PESO UNID.
	<input checked="" type="checkbox"/>	<input type="checkbox"/>	104012	19,59	40	0,550

INCLUIDO EL MANGUITO DE CONEXIÓN AL CONTADOR

Revisión B

VÁLVULAS SALIDA SERIE BS PARA CONTADORES Ø 13, 15 Y 20



SALIDA AUTOMÁTICA DN 13-15

	REF.	EUROS	UNID. DE EMBALAJE	PESO UNID.
DISPOSITIVO ANTIRRETORNO SI <input checked="" type="checkbox"/> NO <input type="checkbox"/>	104022	8,43	50	0,300



SALIDA CON CONEXIÓN A P-E Ø EXT 25 DN 13-15

	REF.	EUROS	UNID. DE EMBALAJE	PESO UNID.
DISPOSITIVO ANTIRRETORNO SI <input checked="" type="checkbox"/> NO <input type="checkbox"/>	104003	20,09	50	0,500

SALIDA CON CONEXIÓN A P-E Ø EXT 32 DN 20

	REF.	EUROS	UNID. DE EMBALAJE	PESO UNID.
DISPOSITIVO ANTIRRETORNO SI <input checked="" type="checkbox"/> NO <input type="checkbox"/>	104013	26,35	30	0,700

OPCIÓN DE MANETA DE LATÓN. CONSULTAR.



SALIDA CON PURGA Y CONEXIÓN A P-E Ø EXT 25 DN 13-15

	REF.	EUROS	UNID. DE EMBALAJE	PESO UNID.
DISPOSITIVO ANTIRRETORNO SI <input checked="" type="checkbox"/> NO <input type="checkbox"/>	103005	25,31	25	0,600

SALIDA CON PURGA CONEXIÓN A P-E Ø EXT 32 DN 20

	REF.	EUROS	UNID. DE EMBALAJE	PESO UNID.
DISPOSITIVO ANTIRRETORNO SI <input checked="" type="checkbox"/> NO <input type="checkbox"/>	103015	29,52	15	0,800

OPCIÓN DE MANETA DE LATÓN. CONSULTAR.



SALIDA CON PURGA Y CONEXIÓN A P-E Ø EXT 25 DN 13-15

	REF.	EUROS	UNID. DE EMBALAJE	PESO UNID.
DISPOSITIVO ANTIRRETORNO SI <input checked="" type="checkbox"/> NO <input type="checkbox"/>	104005	29,03	25	0,500

SALIDA CON PURGA CONEXIÓN A P-E Ø EXT 32 DN 20

	REF.	EUROS	UNID. DE EMBALAJE	PESO UNID.
DISPOSITIVO ANTIRRETORNO SI <input checked="" type="checkbox"/> NO <input type="checkbox"/>	104015	38,22	12	0,800

OPCIÓN DE MANETA DE LATÓN. CONSULTAR.
INCLUIDO EL MANGUITO DE CONEXIÓN AL CONTADOR

Revisión B

VÁLVULAS SALIDA SERIE BS PARA CONTADORES Ø 13, 15 Y 20



SALIDA CON PURGA DN 15

DISPOSITIVO ANTIRRETORNO	SI	NO	REF.	EUROS	UNID. DE EMBALAJE	PESO UNID.
	<input checked="" type="checkbox"/>	<input type="checkbox"/>	104006	21,35	40	0,450

SALIDA CON PURGA DN 20

DISPOSITIVO ANTIRRETORNO	SI	NO	REF.	EUROS	UNID. DE EMBALAJE	PESO UNID.
	<input checked="" type="checkbox"/>	<input type="checkbox"/>	104016	32,19	20	0,850

OPCIÓN DE MANETA DE LATÓN. CONSULTAR.



SALIDA CON PURGA DN 20

DISPOSITIVO ANTIRRETORNO	SI	NO	REF.	EUROS	UNID. DE EMBALAJE	PESO UNID.
	<input checked="" type="checkbox"/>	<input type="checkbox"/>	104026	22,61	20	0,600

OPCIÓN DE MANETA DE LATÓN. CONSULTAR.
INCLUIDO EL MANGUITO DE CONEXIÓN AL CONTADOR

Revisión B

ACCESORIOS VÁLVULAS BS

MONTURA CON PISTONCILLO EPDM DN 13-15

REF.	EUROS	UNID. DE EMBALAJE	PESO UNID.
1029001	6,41	10	0,140

MONTURA CON PISTONCILLO EPDM DN 20

REF.	EUROS	UNID. DE EMBALAJE	PESO UNID.
1029003	10,03	10	0,225

OPCIÓN DE MANETA DE LATÓN. CONSULTAR.

MONTURA FIJA CON PORTASOLETA DN 13-15

REF.	EUROS	UNID. DE EMBALAJE	PESO UNID.
1029002	7,32	10	0,150

MONTURA FIJA CON PORTASOLETA DN 20

REF.	EUROS	UNID. DE EMBALAJE	PESO UNID.
1029005	10,15	10	0,235

OPCIÓN DE MANETA DE LATÓN. CONSULTAR.

PISTONCILLO NBR DN 13-15

REF.	EUROS	UNID. DE EMBALAJE	PESO UNID.
1025004	0,51	25	0,003

PISTONCILLO LATÓN CAUCHO DN 13-15

REF.	EUROS	UNID. DE EMBALAJE	PESO UNID.
1025053	2,38	25	0,012

PISTONCILLO LATÓN CAUCHO DN 20

REF.	EUROS	UNID. DE EMBALAJE	PESO UNID.
1025054	3,01	10	0,016

CUERPO PURGA PARA VÁLVULA SALIDA BATERÍA DN 20

REF.	EUROS	UNID. DE EMBALAJE	PESO UNID.
1020005	9,44	10	0,325

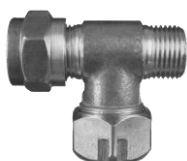
CUERPO PURGA PARA VÁLVULA SALIDA ACOMETIDA DN 13-15

REF.	EUROS	UNID. DE EMBALAJE	PESO UNID.
1020002	10,04	10	0,200

CUERPO PURGA PARA VÁLVULA SALIDA ACOMETIDA DN 20

REF.	EUROS	UNID. DE EMBALAJE	PESO UNID.
1020006	14,84	10	0,300

Revisión B

ACCESORIOS VÁLVULAS BS

MANGUITOS PARA VÁLVULAS DN-13-15 SERIE BS

CONEXIÓN A VÁLVULA 21,8 IZQUIERDAS



DN 15 -1/2" (LL13)

REF.	EUROS	UNID. DE EMBALAJE	PESO UNID.
1021012	2,17	10	0,050

DN 15 -3/4"

REF.	EUROS	UNID. DE EMBALAJE	PESO UNID.
1021034	2,34	10	0,060

DN 15 - 7/8"

REF.	EUROS	UNID. DE EMBALAJE	PESO UNID.
1021078	2,45	10	0,080

DN 15 - 1"

REF.	EUROS	UNID. DE EMBALAJE	PESO UNID.
1021100	3,12	10	0,080

MANGUITOS PARA VÁLVULAS DN 20 SERIE BS

CONEXIÓN A VÁLVULA 7/8" IZQUIERDAS



DN 20 - 3/4"

REF.	EUROS	UNID. DE EMBALAJE	PESO UNID.
1022034	3,44	10	0,098

DN 20 - 7/8"

REF.	EUROS	UNID. DE EMBALAJE	PESO UNID.
1022078	3,27	10	0,095

DN 20 - 1"

REF.	EUROS	UNID. DE EMBALAJE	PESO UNID.
1022100	3,15	10	0,090

MANGUITOS PARA VÁLVULAS DN 20 SERIE BT

CONEXIÓN A VÁLVULA 3/4" IZQUIERDAS

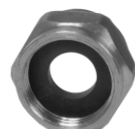

DN 20 -LL13

REF.	EUROS	UNID. DE EMBALAJE	PESO UNID.
1021101	2,34	10	0,060

DN 20 -3/4"

REF.	EUROS	UNID. DE EMBALAJE	PESO UNID.
1022118	2,34	10	0,090

DN 20 - 7/8"

REF.	EUROS	UNID. DE EMBALAJE	PESO UNID.
1022119	3,07	10	0,090

DN 20 - 1"

REF.	EUROS	UNID. DE EMBALAJE	PESO UNID.
1022120	3,15	10	0,090

MANGUITOS PARA VÁLVULAS DN 20 SERIE BS

CONEXIÓN A VÁLVULA 1" IZQUIERDAS



DN 20 - 3/4"

REF.	EUROS	UNID. DE EMBALAJE	PESO UNID.
1022116	3,15	10	0,095

DN 20 - 7/8"

REF.	EUROS	UNID. DE EMBALAJE	PESO UNID.
1022117	3,15	10	0,085

DN 20 - 1"

REF.	EUROS	UNID. DE EMBALAJE	PESO UNID.
1022115	3,12	10	0,085

INCLUIDA JUNTA EPDM EN TODAS LAS REFERENCIAS DE ESTA PÁGINA

Revisión B

ACCESORIOS VÁLVULAS SERIE BS

FILTRO PARA VÁLVULA DE ENTRADA DN 13-15

REF.	EUROS	UNID. DE EMBALAJE	PESO UNID.
01790001	12,21	10	0,200

FILTRO PARA VÁLVULA ENTRADA DN 20

REF.	EUROS	UNID. DE EMBALAJE	PESO UNID.
01790002	18,49	10	0,250

FILTRO PARA VÁLVULA DE ENTRADA DN 13-15 SALIDA ROSCA H 1/2"

REF.	EUROS	UNID. DE EMBALAJE	PESO UNID.
11790001	8,29	10	0,175

FILTRO PARA VÁLVULA ENTRADA DN 20 SALIDA ROSCA H 3/4"

REF.	EUROS	UNID. DE EMBALAJE	PESO UNID.
11790002	14,10	10	0,300

Revisión B

ACCESORIOS VÁLVULAS SERIE BS



JUNTA PLANA EPDM PARA VÁLVULA ENTRADA FIJA DN 15 BS

REF.	EUROS	UNID. DE EMBALAJE	PESO UNID.
1026110	0,50	25	0,012

JUNTA PLANA EPDM PARA VÁLVULA ENTRADA FIJA DN 20 BS

REF.	EUROS	UNID. DE EMBALAJE	PESO UNID.
1026111	0,66	25	0,014

JUNTA PLANA EPDM PARA VÁLVULA ENTRADA ORIENTABLE DN 15 BS

REF.	EUROS	UNID. DE EMBALAJE	PESO UNID.
1035110	0,50	25	0,014

JUNTA PLANA EPDM PARA VÁLVULA ENTRADA ORIENTABLE DN 20 BS

REF.	EUROS	UNID. DE EMBALAJE	PESO UNID.
10029051	0,83	25	0,014



JUNTA PLANA EPDM PARA MANGUITO DN 15-1/2" BS

REF.	EUROS	UNID. DE EMBALAJE	PESO UNID.
1025114	0,14	10	0,005

JUNTA PLANA EPDM PARA MANGUITO DN 15-3/4" BS

REF.	EUROS	UNID. DE EMBALAJE	PESO UNID.
1025111	0,17	10	0,007

JUNTA PLANA EPDM PARA MANGUITO DN 15-7/8" BS

REF.	EUROS	UNID. DE EMBALAJE	PESO UNID.
1025112	0,22	10	0,008

JUNTA PLANA EPDM PARA MANGUITO DN 15-1" BS

REF.	EUROS	UNID. DE EMBALAJE	PESO UNID.
1025113	0,27	10	0,008



JUNTA PLANA EPDM PARA MANGUITO DN 20-3/4" BS

REF.	EUROS	UNID. DE EMBALAJE	PESO UNID.
1025161	0,22	10	0,009

JUNTA PLANA EPDM PARA MANGUITO DN 20-7/8" BS

REF.	EUROS	UNID. DE EMBALAJE	PESO UNID.
1025162	0,22	10	0,011

JUNTA PLANA EPDM PARA MANGUITO DN 20-1" BS

REF.	EUROS	UNID. DE EMBALAJE	PESO UNID.
1025163	0,23	10	0,011

Revisión B

TORNILLERÍA

TORNILLO M-10x30 INOX C/T

REF.	EUROS	UNID. DE EMBALAJE	PESO UNID.
202019	0,86	10	0,020

TORNILLO M-10x20 ZINCADO

REF.	EUROS	UNID. DE EMBALAJE	PESO UNID.
202001	0,25	10	0,015

TORNILLO M-10x30 ZINCADO

REF.	EUROS	UNID. DE EMBALAJE	PESO UNID.
202003	0,30	10	0,020

TORNILLO M-10x35 ZINCADO C/T

REF.	EUROS	UNID. DE EMBALAJE	PESO UNID.
202005	0,35	10	0,025



TORNILLO M-10x20 ZINCADO C/BASE

REF.	EUROS	UNID. DE EMBALAJE	PESO UNID.
202021	0,50	10	0,010

TORNILLO M-10x25 ZINCADO C/BASE

REF.	EUROS	UNID. DE EMBALAJE	PESO UNID.
202020	0,54	10	0,010

TORNILLO M-12x20 ZINCADO C/BASE

REF.	EUROS	UNID. DE EMBALAJE	PESO UNID.
202050	0,81	10	0,015

TORNILLO M-12x25 ZINCADO C/BASE

REF.	EUROS	UNID. DE EMBALAJE	PESO UNID.
202075	0,90	10	0,015

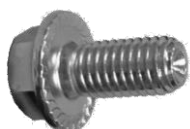

Revisión B

VÁLVULAS ESFERA

SERIE BT

Revisión B

23/01



Revisión B

ÍNDICE

PAG. 51-53..... VÁLVULAS SERIE BT

PAG. 54-55..... VÁLVULAS LINEALES CON SISTEMA ANTIFRAUDE MAGNÉTICO

PAG. 56..... VÁLVULAS H-H PN25 EQUIPADAS CON DISPOSITIVO ANTIFRAUDE

PAG. 57-60..... ESPECIFICACIONES TÉCNICAS DE TAPÓN Y LLAVE ANTIFRAUDE



Revisión B

VÁLVULAS ENTRADA SERIE BT CON SISTEMA ANTIFRAUDE MAGNÉTICO
PARA CONTADORES DN 13, 15 Y 20mm.



ENTRADA ORIENTABLE DN 20 MANGUITO 3/4" – 7/8" – 1"

DISPOSITIVO ANTIRRETORNO	SI	NO	REF.	EUROS	UNID. DE EMBALAJE	PESO UNID.
	<input type="checkbox"/>	<input checked="" type="checkbox"/>	BT101011	23,13	32	0,550

OPCIÓN DE MANETA DE LATÓN. CONSULTAR



ENTRADA ORIENTABLE CON TAPÓN ANTIFRAUDE PARA CONTADOR DN 20 MANGUITO 3/4" – 7/8" – 1"

DISPOSITIVO ANTIRRETORNO	SI	NO	REF.	EUROS	UNID. DE EMBALAJE	PESO UNID.
	<input type="checkbox"/>	<input checked="" type="checkbox"/>	BT101111	25,22	32	0,500



ENTRADA ROSCADA 3/4" DN 13-15 RACOR 7/8"-3/4"

DISPOSITIVO ANTIRRETORNO	SI	NO	REF.	EUROS	UNID. DE EMBALAJE	PESO UNID.
	<input type="checkbox"/>	<input checked="" type="checkbox"/>	BT104113	18,03	32	0,450

ENTRADA ROSCADA 1" DN 20 RACOR 1"

DISPOSITIVO ANTIRRETORNO	SI	NO	REF.	EUROS	UNID. DE EMBALAJE	PESO UNID.
	<input type="checkbox"/>	<input checked="" type="checkbox"/>	BT104112	20,20	32	0,550

OPCIÓN DE MANETA DE LATÓN. CONSULTAR



ENTRADA ROSCADA 3/4" CON TAPÓN ANTIFRAUDE PARA CONTADOR DN 13-15 RACOR 7/8"-3/4"

DISPOSITIVO ANTIRRETORNO	SI	NO	REF.	EUROS	UNID. DE EMBALAJE	PESO UNID.
	<input type="checkbox"/>	<input checked="" type="checkbox"/>	BT104123	19,67	32	0,350

ENTRADA ROSCADA 1" CON TAPÓN ANTIFRAUDE PARA CONTADOR DN 20 RACOR 1"

DISPOSITIVO ANTIRRETORNO	SI	NO	REF.	EUROS	UNID. DE EMBALAJE	PESO UNID.
	<input type="checkbox"/>	<input checked="" type="checkbox"/>	BT104122	20,74	32	0,508

DISPUESTAS CON BLOQUEO DE VOLANTE PARA POSICIÓN DE MÍNIMO VITAL CON SISTEMA DE SEGURIDAD

INCLUIDOS MANGUITOS Y RACORES DE CONEXIÓN AL CONTADOR

Revisión B

VÁLVULAS ENTRADA SERIE BT CON SISTEMA ANTIFRAUDE MAGNÉTICO PARA CONTADORES DN 13, 15 Y 20 mm.



ENTRADA ROSCADA 1" PARA CONTADOR DN 13-15 RACOR 7/8"-3/4"

DISPOSITIVO ANTIRRETORNO	SI	NO	REF.	EUROS	UNID. DE EMBALAJE	PESO UNID.
	<input type="checkbox"/>	<input checked="" type="checkbox"/>	BT104011	20,79	32	0,460

OPCIÓN DE MANETA DE LATÓN. CONSULTAR



ENTRADA ROSCADA 1" CON TAPÓN ANTIFRAUDE PARA CONTADOR DN 13-15 RACOR 7/8"-3/4"

DISPOSITIVO ANTIRRETORNO	SI	NO	REF.	EUROS	UNID. DE EMBALAJE	PESO UNID.
	<input type="checkbox"/>	<input checked="" type="checkbox"/>	BT104015	21,71	32	0,360



ENTRADA CON CONEXIÓN A P.E. ØEXT 25 PARA CONTADOR DN 13-15

DISPOSITIVO ANTIRRETORNO	SI	NO	REF.	EUROS	UNID. DE EMBALAJE	PESO UNID.
	<input type="checkbox"/>	<input checked="" type="checkbox"/>	BT104813	25,38	32	0,628

ENTRADA CON CONEXIÓN A P.E. ØEXT 32 PARA CONTADOR DN 20

DISPOSITIVO ANTIRRETORNO	SI	NO	REF.	EUROS	UNID. DE EMBALAJE	PESO UNID.
	<input type="checkbox"/>	<input checked="" type="checkbox"/>	BT104811	28,81	32	0,754

OPCIÓN DE MANETA DE LATÓN. CONSULTAR



ENTRADA CON CONEXIÓN A P.E. ØEXT 25 CON TAPÓN ANTIFRAUDE PARA CONTADOR DN 13-15 RACOR 7/8"-3/4"

DISPOSITIVO ANTIRRETORNO	SI	NO	REF.	EUROS	UNID. DE EMBALAJE	PESO UNID.
	<input type="checkbox"/>	<input checked="" type="checkbox"/>	BT104814	25,72	32	0,581

ENTRADA CON CONEXIÓN A P.E. ØEXT 32 CON TAPÓN ANTIFRAUDE PARA CONTADOR DN 20 RACOR 1"

DISPOSITIVO ANTIRRETORNO	SI	NO	REF.	EUROS	UNID. DE EMBALAJE	PESO UNID.
	<input type="checkbox"/>	<input checked="" type="checkbox"/>	BT104812	30,84	32	0,707

DISPUESTAS CON BLOQUEO DE VOLANTE PARA POSICIÓN DE MÍNIMO VITAL CON SISTEMA DE SEGURIDAD

INCLUIDOS RACORES DE CONEXIÓN AL CONTADOR

Revisión B

VÁLVULAS SALIDA SERIE BT PARA CONTADORES DN 13, 15 Y 20 mm.
CON ANTIRRETORNO Y PURGA INCORPORADA



SALIDA BATERÍA PARA CONTADOR DN 20 MANGUITO 3/4" - 1"

DISPOSITIVO ANTIRRETORNO	SI	NO	REF.	EUROS	UNID. DE EMBALAJE	PESO UNID.
	<input checked="" type="checkbox"/>	<input type="checkbox"/>	BT102011	18,96	32	0,500

OPCIÓN DE MANETA DE LATÓN. CONSULTAR



SALIDA ROSCADA 3/4" PARA CONTADOR DN 13-15 RACOR 3/4"

DISPOSITIVO ANTIRRETORNO	SI	NO	REF.	EUROS	UNID. DE EMBALAJE	PESO UNID.
	<input checked="" type="checkbox"/>	<input type="checkbox"/>	BT105001	19,59	32	0,450

SALIDA ROSCADA 1" PARA CONTADOR DN 20 RACOR 1"

DISPOSITIVO ANTIRRETORNO	SI	NO	REF.	EUROS	UNID. DE EMBALAJE	PESO UNID.
	<input checked="" type="checkbox"/>	<input type="checkbox"/>	BT105101	20,90	32	0,595

OPCIÓN DE MANETA DE LATÓN. CONSULTAR



SALIDA ROSCADA 1" PARA CONTADOR DN 13-15 RACOR 3/4"

DISPOSITIVO ANTIRRETORNO	SI	NO	REF.	EUROS	UNID. DE EMBALAJE	PESO UNID.
	<input checked="" type="checkbox"/>	<input type="checkbox"/>	BT105501	22,36	32	0,350

OPCIÓN DE MANETA DE LATÓN. CONSULTAR



SALIDA CON CONEXIÓN A P.E. ØEXT 25 PARA CONTADOR DN 13-15

DISPOSITIVO ANTIRRETORNO	SI	NO	REF.	EUROS	UNID. DE EMBALAJE	PESO UNID.
	<input checked="" type="checkbox"/>	<input type="checkbox"/>	BT105801	26,81	32	0,663

SALIDA CON CONEXIÓN A P.E. ØEXT 32 PARA CONTADOR DN 20

DISPOSITIVO ANTIRRETORNO	SI	NO	REF.	EUROS	UNID. DE EMBALAJE	PESO UNID.
	<input checked="" type="checkbox"/>	<input type="checkbox"/>	BT105811	29,20	32	0,794

DISPUESTAS CON BLOQUEO DE VOLANTE PARA POSICIÓN DE MÍNIMO VITAL CON SISTEMA DE SEGURIDAD

OPCIÓN DE MANETA DE LATÓN. CONSULTAR
INCLUIDOS MANGUITOS Y RACORES DE CONEXIÓN AL CONTADOR

Revisión B

VÁLVULAS LINEALES H SERIE BT PN25 CON SISTEMA ANTIFRAUDE MAGNÉTICO



VÁLVULA H-H 1/2" DN15

REF.	EUROS	UNID. DE EMBALAJE	PESO UNID.
BT106001	7,43	50	0,233

VÁLVULA H-H 3/4" DN20

REF.	EUROS	UNID. DE EMBALAJE	PESO UNID.
BT106201	10,19	50	0,319

VÁLVULA H-H 1" DN25

REF.	EUROS	UNID. DE EMBALAJE	PESO UNID.
BT106401	16,90	50	0,454



VÁLVULA H-H 1/2" DN15 CON TAPÓN DE BLOQUEO MAGNÉTICO

REF.	EUROS	UNID. DE EMBALAJE	PESO UNID.
BT106101	8,46	50	0,232

VÁLVULA H-H 3/4" DN20 CON TAPÓN DE BLOQUEO MAGNÉTICO BLOQUEO

REF.	EUROS	UNID. DE EMBALAJE	PESO UNID.
BT106301	11,66	50	0,316

VÁLVULA H-H 1" DN25 CON TAPÓN DE BLOQUEO MAGNÉTICO

REF.	EUROS	UNID. DE EMBALAJE	PESO UNID.
BT106501	17,99	50	0,408



VÁLVULA H 1/2" DN15 CON RACOR DE CONEXIÓN 3/4"-7/8"

REF.	EUROS	UNID. DE EMBALAJE	PESO UNID.
BT106002	12,72	50	0,285

VÁLVULA H 3/4" DN20 CON RACOR DE CONEXIÓN 3/4"-7/8"-1"

REF.	EUROS	UNID. DE EMBALAJE	PESO UNID.
BT106202	15,24	50	0,420

VÁLVULA H 1" DN25 CON RACOR DE CONEXIÓN 1 1/4"

REF.	EUROS	UNID. DE EMBALAJE	PESO UNID.
BT106402	27,39	50	0,650



VÁLVULA H 1/2" DN15 RACOR DE CONEXIÓN 3/4"-7/8" Y TAPÓN DE BLOQUEO MAGNÉTICO

REF.	EUROS	UNID. DE EMBALAJE	PESO UNID.
BT106102	11,03	50	0,245

VÁLVULA H 3/4" DN20 RACOR DE CONEXIÓN 3/4"-7/8"-1" Y TAPÓN DE BLOQUEO MAGNÉTICO

REF.	EUROS	UNID. DE EMBALAJE	PESO UNID.
BT106302	16,70	50	0,416

VÁLVULA H 1" DN25 RACOR DE CONEXIÓN 1 1/4" Y TAPÓN DE BLOQUEO MAGNÉTICO

REF.	EUROS	UNID. DE EMBALAJE	PESO UNID.
BT106502	26,59	50	0,646

DISPUESTAS CON BLOQUEO DE VOLANTE PARA POSICIÓN DE MÍNIMO VITAL CON SISTEMA DE SEGURIDAD

Revisión B

VÁLVULAS LINEALES SERIE BT PN25 CON CUADRADILLO 30x30 Y SISTEMA ANTIFRAUDE MAGNÉTICO



VÁLVULA H-H 1/2" DN15

REF.	EUROS	UNID. DE EMBALAJE	PESO UNID.
BT107401	12,33	50	0,300

VÁLVULA H-H 3/4" DN20

REF.	EUROS	UNID. DE EMBALAJE	PESO UNID.
BT107402	15,07	50	0,380

VÁLVULA H-H 1" DN25

REF.	EUROS	UNID. DE EMBALAJE	PESO UNID.
BT107403	21,28	50	0,505

VÁLVULAS LINEALES PN25 CON SISTEMA DE CORTE ANTIFRAUDE MAGNÉTICO



VÁLVULA H-H 1/2" DN15

REF.	EUROS	UNID. DE EMBALAJE	PESO UNID.
BTM106401	8,18	50	0,167

VÁLVULA H-H 3/4" DN20

REF.	EUROS	UNID. DE EMBALAJE	PESO UNID.
BTM106402	11,60	50	0,239

VÁLVULA H-H 1" DN25

REF.	EUROS	UNID. DE EMBALAJE	PESO UNID.
BTM106403	16,06	50	0,324

VÁLVULA H-H 1 1/4" DN30

REF.	EUROS	UNID. DE EMBALAJE	PESO UNID.
BTM106404	25,93	50	0,510

VÁLVULA H-H 1 1/2" DN40

REF.	EUROS	UNID. DE EMBALAJE	PESO UNID.
BTM106405	38,53	50	0,758

VÁLVULA H-H 2" DN50

REF.	EUROS	UNID. DE EMBALAJE	PESO UNID.
BTM106406	60,66	50	1,227

Revisión B



LLAVE PARA DESBLOQUEO TORNILLO ANTIFRAUDE

REF.	EUROS	UNID. DE EMBALAJE	PESO UNID.
BTR101092	3,05	1	0,021



TAPÓN ANTIFRAUDE

REF.	EUROS	UNID. DE EMBALAJE	PESO UNID.
BTR101090	2,41	1	0,033



LLAVE PARA DESBLOQUEO EXCLUSIVA PARA COMPAÑÍAS DE AGUA

REF.	EUROS	UNID. DE EMBALAJE	PESO UNID.
BTR101091	5,00	1	0,023



TORNILLO ANTIFRAUDE

MODELO	REF.	EUROS	UNID. DE EMBALAJE	PESO UNID.
M4x16	BTR101098	0,51	100	0,002
M5x16	BTR101099	0,74	100	0,002

Revisión B

SISTEMA ADAPTABLE A TODOS LOS MODELOS DE VÁLVULAS DEL MERCADO

**VÁLVULA ESTANDAR CON
DISPOSITIVO DE CIERRE MANUAL**



**VÁLVULA CON ADAPTADOR
PARA TAPÓN ANTIFRAUDE**



SISTEMA PATENTADO

**LLAVE PARA DESBLOQUEO EXCLUSIVO
PARA COMPAÑÍAS DE AGUAS**



**VÁLVULA CON TAPÓN ANTIFRAUDE
Y LLAVE MAGNÉTICA PARA EL
DESBLOQUEO DEL TAPÓN ANTIFRAUDE**

**VÁLVULA CON TAPÓN
ANTIFRAUDE**



**VÁLVULAS DE BOLA CON SISTEMA ANTIFRAUDE, CON BLOQUEO DE LA VÁLVULA
MEDIANTE SISTEMA MAGNÉTICO**

EL ÚNICO SISTEMA ANTIFRAUDE A NIVEL MUNDIAL QUE SE PUEDE ADAPTAR A CUALQUIER MODELO DE VÁLVULA DEL MERCADO, MEDIANTE ADAPTADORES PARA CADA MODELO.

LLAVE PARA DESBLOQUEO
EXCLUSIVO PARA COMPAÑÍAS DE AGUAS



SISTEMA PATENTADO

TAPÓN ANTIFRAUDE



VÁLVULA CON DISPOSITIVO DE TRANSFORMACIÓN DISPONIBLE PARA TODOS LOS MODELOS DE VÁLVULAS DE CUALQUIER FABRICANTE

VÁLVULA CON EL ADAPTADOR INCORPORADO

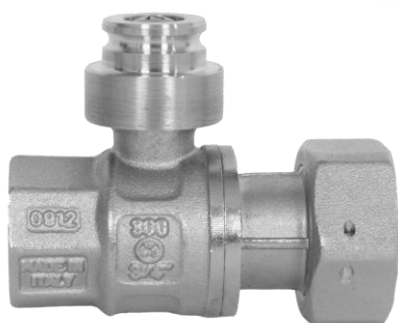

Revisión B

LLAVE DE DESBLOQUEO EXCLUSIVO PARA COMPAÑÍAS DE AGUAS

**VÁLVULA ESTANDAR
MONTADA CON VOLANTE**



**VÁLVULA SIN DISPOSITIVO
DE TRANSFORMACIÓN**



SISTEMA PATENTADO

**VÁLVULA CON DISPOSITIVO DE
TRANSFORMACIÓN INSTALADO**



**DETALLE DE POSICIONAMIENTO
DEL DISPOSITIVO DE TRANSFORMACIÓN**

**LLAVE DE DESBLOQUEO EXCLUSIVO
PARA COMPAÑÍAS DE AGUAS**



**DETALLE DE POSICIONAMIENTO
DEL TAPÓN ANTIFRAUDE**



**VÁLVULA MONTADA CON TAPÓN
ANTIFRAUDE Y LLAVE MAGNETICA PARA
EL DESBLOQUEO DEL TAPÓN ANTIFRAUDE**

Revisión B

INSTRUCCIONES PARA EL BLOQUEO Y DESBLOQUEO DE LA VÁLVULA DE ESFERA ANTIFRAUDE DN20 REF. BT101011 Y BT102011**BLOQUEO DEL TAPÓN ANTIFRAUDE REF. BTR101090.**

1. Desmontar el volante de la válvula aflojando el tornillo de cabeza en cruz situado encima de este.
2. Introducir el tapón Antifraude en la parte superior de la válvula hasta que este quede bloqueado.
3. Si el tapón Antifraude se bloquea manualmente fuera de la válvula, habrá que desbloquearlo mediante la llave de condensa **REF. BTR101091** y se procede de la siguiente forma; se sitúa la letra **B** del tapón Antifraude **REF. BTR101090** y la letra **B** de la llave de condensa de manera que coincidan las dos, a continuación se oprime hacia dentro el sistema de bloqueo y al soltar debe quedar desbloqueado el tapón Antifraude.

**Llave de condensa
Ref. BTR101091****DESBLOQUEO DEL TAPÓN ANTIFRAUDE REF. BTR101090.**

1. Se posiciona la llave de condensa **REF. BTR101091** encima del tapón Antifraude **REF. BTR101090** de manera que coincida la letra **B** de la llave de condensa con la letra **B** del tapón Antifraude, a continuación presionar hacia abajo y el tapón Antifraude quedará desbloqueado.

**Tapón Antifraude
Ref. BTR101090****INFORMACIÓN TÉCNICA:**

El desbloqueo del tapón Antifraude se consigue a través del campo magnético que genera la llave de condensa, la cual dispone de unos imanes situados estratégicamente en el interior de la llave de condensa, que activa el sistema de bloqueo del tapón para conseguir el desbloqueo de este, siendo imposible poder abrir el sistema de bloqueo de otra forma.

SISTEMA PATENTADO

VÁLVULAS ESFERA

SERIE BS

Revisión B

23/01



Revisión B

ÍNDICE

PAG. 63-68..... VÁLVULAS SERIE ESFERA

PAG. 69-70..... ACCESORIOS VÁLVULAS SERIE ESFERA

PAG. 71-72..... VÁLVULAS DE BOLA RECTAS EN PVC

Revisión B



VÁLVULAS ENTRADA PARA CONTADORES Ø 13, 15 Y 20

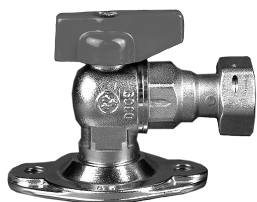

ENTRADA ORIENTABLE DN 15 RACOR 3/4"-7/8"

DISPOSITIVO ANTIRRETORNO	SI	NO	REF.	EUROS	UNID. DE EMBALAJE	PESO UNID.
	<input type="checkbox"/>	<input checked="" type="checkbox"/>	111001	17,07	50	0,400



ENTRADA ORIENTABLE Y ANTIFRAUDE DN 15 RACOR 3/4"-7/8"

DISPOSITIVO ANTIRRETORNO	SI	NO	REF.	EUROS	UNID. DE EMBALAJE	PESO UNID.
	<input type="checkbox"/>	<input checked="" type="checkbox"/>	111122	24,75	40	0,425



ENTRADA ORIENTABLE DN 15 RACOR 3/4"-7/8"

DISPOSITIVO ANTIRRETORNO	SI	NO	REF.	EUROS	UNID. DE EMBALAJE	PESO UNID.
	<input type="checkbox"/>	<input checked="" type="checkbox"/>	111004	19,31	50	0,375

ENTRADA ORIENTABLE Y ANTIFRAUDE DN 20 RACOR 1"

DISPOSITIVO ANTIRRETORNO	SI	NO	REF.	EUROS	UNID. DE EMBALAJE	PESO UNID.
	<input type="checkbox"/>	<input checked="" type="checkbox"/>	111044	19,55	40	0,500

Revisión B

VÁLVULAS ENTRADA PARA CONTADORES Ø 13, 15 Y 20



ENTRADA DN 15 M-3/4\"

DISPOSITIVO ANTIRRETORNO	SI	NO	REF.	EUROS	UNID. DE EMBALAJE	PESO UNID.
	<input type="checkbox"/>	<input checked="" type="checkbox"/>	112001	10,53	50	0,230



ENTRADA CON DISPOSITIVO ANTIFRAUDE DN 15 M-3/4\"

DISPOSITIVO ANTIRRETORNO	SI	NO	REF.	EUROS	UNID. DE EMBALAJE	PESO UNID.
	<input type="checkbox"/>	<input checked="" type="checkbox"/>	111200	18,91	50	0,235



MACHO 3/4\"

DISPOSITIVO ANTIRRETORNO	SI	NO	REF.	EUROS	UNID. DE EMBALAJE	PESO UNID.
	<input type="checkbox"/>	<input checked="" type="checkbox"/>	115001	5,93	50	0,200

RACORES INCLUIDOS EXCEPTO REF.115001

FILTROS PARA VÁLVULAS ESFERA PÁG. 46

Revisión B

VÁLVULAS ENTRADA PARA CONTADORES Ø 13, 15 Y 20



ENTRADA DN 15 CON CONEXIÓN A P-E Ø EXT 25 RACOR 3/4"

DISPOSITIVO ANTIRRETORNO	SI	NO	REF.	EUROS	UNID. DE EMBALAJE	PESO UNID.
	<input type="checkbox"/>	<input checked="" type="checkbox"/>	112003	12,88	50	0,375

* Hasta fin de existencias



ENTRADA DN 15 CON DISPOSITIVO ANTIFRAUDE Y CONEXIÓN A P-E Ø EXT 25 RACOR 3/4"

DISPOSITIVO ANTIRRETORNO	SI	NO	REF.	EUROS	UNID. DE EMBALAJE	PESO UNID.
	<input type="checkbox"/>	<input checked="" type="checkbox"/>	112020	24,65	40	0,235

* Hasta fin de existencias



ENTRADA DN 15 H 1/2" RACOR 3/4"

DISPOSITIVO ANTIRRETORNO	SI	NO	REF.	EUROS	UNID. DE EMBALAJE	PESO UNID.
	<input type="checkbox"/>	<input checked="" type="checkbox"/>	115201	8,10	50	0,150

ENTRADA DN 20 H 3/4" RACOR 3/4"

DISPOSITIVO ANTIRRETORNO	SI	NO	REF.	EUROS	UNID. DE EMBALAJE	PESO UNID.
	<input type="checkbox"/>	<input checked="" type="checkbox"/>	115202-3/4"	10,32	50	0,260

ENTRADA DN 20 H 3/4" RACOR 7/8"

DISPOSITIVO ANTIRRETORNO	SI	NO	REF.	EUROS	UNID. DE EMBALAJE	PESO UNID.
	<input type="checkbox"/>	<input checked="" type="checkbox"/>	115202-7/8"	10,18	50	0,260

ENTRADA DN 20 H 3/4" RACOR 1"

DISPOSITIVO ANTIRRETORNO	SI	NO	REF.	EUROS	UNID. DE EMBALAJE	PESO UNID.
	<input type="checkbox"/>	<input checked="" type="checkbox"/>	115203	13,39	50	0,275

INCLUIDOS RACORES DE CONEXIÓN AL CONTADOR

FILTROS PARA VÁLVULAS ESFERA PÁG. 59

VÁLVULA PORTASONDAS



ROSCA GAS	REF.	EUROS	UNID. EMBALAJE	PESO UNID.
3/4" x M10	99000037	13,63	50	0,270

Revisión B

VÁLVULAS ENTRADA PARA CONTADORES Ø 13, 15 Y 20

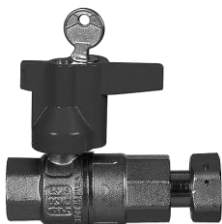

ENTRADA DN 15 CON DISPOSITIVO ANTIFRAUDE H 1/2" RACOR 3/4"-7/8"

DISPOSITIVO ANTIRRETORNO	SI	NO	REF.	EUROS	UNID. DE EMBALAJE	PESO UNID.
	<input checked="" type="checkbox"/>	<input type="checkbox"/>	114020	38,06	50	0,155



ENTRADA DN 15 H 1/2" RACOR 3/4"

DISPOSITIVO ANTIRRETORNO	SI	NO	REF.	EUROS	UNID. DE EMBALAJE	PESO UNID.
	<input checked="" type="checkbox"/>	<input type="checkbox"/>	116001-3/4"	10,91	50	0,225

ENTRADA DN 15 H 1/2" RACOR 7/8"

DISPOSITIVO ANTIRRETORNO	SI	NO	REF.	EUROS	UNID. DE EMBALAJE	PESO UNID.
	<input checked="" type="checkbox"/>	<input type="checkbox"/>	116001-7/8"	14,21	50	0,225



ENTRADA DN 15 CON RACOR TELESCÓPICO H-1/2" RACOR 3/4"

DISPOSITIVO ANTIRRETORNO	SI	NO	REF.	EUROS	UNID. DE EMBALAJE	PESO UNID.
	<input type="checkbox"/>	<input checked="" type="checkbox"/>	115301	14,12	50	0,260

ENTRADA DN 20 CON RACOR TELESCÓPICO H-3/4" RACOR 1"

DISPOSITIVO ANTIRRETORNO	SI	NO	REF.	EUROS	UNID. DE EMBALAJE	PESO UNID.
	<input type="checkbox"/>	<input checked="" type="checkbox"/>	115302	16,88	30	0,400

*Hasta fin de existencias

INCLUIDOS RACORES DE CONEXIÓN AL CONTADOR

FILTROS PARA VÁLVULAS ESFERA PÁG. 69

VÁLVULAS LINEALES PN25 H ADAPTABLES AL SISTEMA ANTIFRAUDE MAGNÉTICO



* Hasta fin de existencias

VÁLVULA H-H 1" PN25

DISPOSITIVO ANTIRRETORNO	SI	NO	REF.	EUROS	UNID. DE EMBALAJE	PESO UNID.
	<input type="checkbox"/>	<input checked="" type="checkbox"/>	118300-1" (*)	12,84	30	0,368

VÁLVULA H-H 1 1/4" PN25

DISPOSITIVO ANTIRRETORNO	SI	NO	REF.	EUROS	UNID. DE EMBALAJE	PESO UNID.
	<input type="checkbox"/>	<input checked="" type="checkbox"/>	118300-11/4" (*)	19,68	30	0,575

VÁLVULA H-H 1 1/2" PN25

DISPOSITIVO ANTIRRETORNO	SI	NO	REF.	EUROS	UNID. DE EMBALAJE	PESO UNID.
	<input type="checkbox"/>	<input checked="" type="checkbox"/>	118300-11/2" (*)	28,41	20	0,781

VÁLVULA H-H 2" PN25

DISPOSITIVO ANTIRRETORNO	SI	NO	REF.	EUROS	UNID. DE EMBALAJE	PESO UNID.
	<input type="checkbox"/>	<input checked="" type="checkbox"/>	118300-2" (*)	45,03	10	1,323

VÁLVULAS SALIDA PARA CONTADORES Ø 13, 15 Y 20



SALIDA DN 15 CON PURGA Y RACOR 3/4"

	REF.	EUROS	UNID. DE EMBALAJE	PESO UNID.
DISPOSITIVO ANTIRRETORNO <input checked="" type="checkbox"/> SI <input type="checkbox"/> NO	113009	12,36	50	0,240



SALIDA DN 15 CON PURGA Y CONEXIÓN A P-E Ø EXT 25 RACOR 3/4"

	REF.	EUROS	UNID. DE EMBALAJE	PESO UNID.
DISPOSITIVO ANTIRRETORNO <input checked="" type="checkbox"/> SI <input type="checkbox"/> NO	113007	19,55	50	0,375

INCLUIDOS RACORES DE CONEXIÓN AL CONTADOR

FILTROS PARA VÁLVULAS ESFERA PÁG. 69



SALIDA DN 20 CON PURGA H 3/4 - RACOR 3/4"

	REF.	EUROS	UNID. DE EMBALAJE	PESO UNID.
DISPOSITIVO ANTIRRETORNO <input checked="" type="checkbox"/> SI <input type="checkbox"/> NO	110003	14,37	50	0,330

INCLUIDOS RACORES DE CONEXIÓN AL CONTADOR

FILTROS PARA VÁLVULAS ESFERA PÁG. 69

Revisión B

VÁLVULAS SALIDA PARA CONTADORES Ø 13, 15 Y 20

SALIDA DN 15 H-1/2" RACOR 3/4"

DISPOSITIVO ANTIRRETORNO	SI	NO	REF.	EUROS	UNID. DE EMBALAJE	PESO UNID.
	<input checked="" type="checkbox"/>	<input type="checkbox"/>	117001	10,06	50	0,225

SALIDA DN 20 H-3/4" RACOR 3/4"

DISPOSITIVO ANTIRRETORNO	SI	NO	REF.	EUROS	UNID. DE EMBALAJE	PESO UNID.
	<input checked="" type="checkbox"/>	<input type="checkbox"/>	117111	13,35	50	0,415

SALIDA DN 20 H-3/4" RACOR 1" (*)

DISPOSITIVO ANTIRRETORNO	SI	NO	REF.	EUROS	UNID. DE EMBALAJE	PESO UNID.
	<input checked="" type="checkbox"/>	<input type="checkbox"/>	117011	19,19	50	0,425

*Hasta fin de existencias

INCLUIDOS RACORES DE CONEXIÓN AL CONTADOR

FILTROS PARA VÁLVULAS ESFERA PÁG. 69

Revisión B



ACCESORIOS VÁLVULAS ESFERA



TUERCA RACOR 3/4" CON JUNTA

REF.	EUROS	UNID. DE EMBALAJE	PESO UNID.
1031034	2,27	10	0,033

TUERCA RACOR 7/8" CON JUNTA

REF.	EUROS	UNID. DE EMBALAJE	PESO UNID.
1031078	2,72	10	0,042



FILTRO PARA VÁLVULA DE ESFERA DN 15 M-3/4" RACOR 3/4"-7/8"

REF.	EUROS	UNID. DE EMBALAJE	PESO UNID.
02790001	14,81	15	0,210

FILTRO PARA VÁLVULA DE ESFERA DN 20 M-1" RACOR 1"

REF.	EUROS	UNID. DE EMBALAJE	PESO UNID.
02790002	15,09	6	0,250

ACCESORIOS VÁLVULAS ESFERA



JUNTA PLANA EPDM 3/4" PARA RACOR VÁLVULA ESFERA DN 15

REF.	EUROS	UNID. DE EMBALAJE	PESO UNID.
1035111	0,19	25	0,012

JUNTA PLANA EPDM 7/8" PARA RACOR VÁLVULA ESFERA DN 15

REF.	EUROS	UNID. DE EMBALAJE	PESO UNID.
1035112	0,23	25	0,014

JUNTA PLANA EPDM 1" PARA RACOR VÁLVULA ESFERA DN 20

REF.	EUROS	UNID. DE EMBALAJE	PESO UNID.
1035161	0,27	25	0,015



JUNTA PLANA EPDM PARA BRIDA ORIENTABLE DN 15

REF.	EUROS	UNID. DE EMBALAJE	PESO UNID.
1035110	0,50	25	0,018



CONJUNTO DE ACCESORIOS PARA MONTAJE VÁLVULA ORIENTABLE DN 15 3/4" ESFERA

REF.	EUROS	UNID. DE EMBALAJE	PESO UNID.
1039996	1,51	10	0,090

CONJUNTO DE ACCESORIOS PARA MONTAJE VÁLVULA ORIENTABLE DN 15 7/8" ESFERA

REF.	EUROS	UNID. DE EMBALAJE	PESO UNID.
1039995	1,52	10	0,100

Revisión B

VÁLVULAS DE BOLA RECTAS EN PVC PN10 CON SISTEMA ANTIFRAUDE MAGNÉTICO



H-H 1/2" DN15

REF.	EUROS	UNID. DE EMBALAJE	PESO UNID.
PVC10001	5,48	100	0,126

Opcional con tornillo antifraude



H-H 1/2" DN15 CON TAPÓN DE BLOQUEO MAGNÉTICO

REF.	EUROS	UNID. DE EMBALAJE	PESO UNID.
PVC10101	7,61	100	0,126



M-H 1/2"

REF.	EUROS	UNID. DE EMBALAJE	PESO UNID.
PVC10002	7,51	80	0,168

Opcional con tornillo antifraude



H 1/2" RACOR DE NYLON 3/4" – 7/8"

REF.	EUROS	UNID. DE EMBALAJE	PESO UNID.
PVC10003	6,62	80	0,150

Opcional con tornillo antifraude



H 1/2" RACOR DE NYLON 3/4" – 7/8" CON TAPÓN DE BLOQUEO MAGNÉTICO

REF.	EUROS	UNID. DE EMBALAJE	PESO UNID.
PVC10103	8,76	80	0,150

DISPUESTAS CON BLOQUEO DE VOLANTE PARA POSICIÓN DE MÍNIMO VITAL CON SISTEMA DE SEGURIDAD

TODAS LAS VÁLVULAS DISPONEN DE ROSCA CON INSERTO METÁLICO

PARA VÁLVULAS CON TORNILLO ANTIFRAUDE SUMAR LA REF. BTR101098 DE LA PÁGINA 56

Revisión B

VÁLVULAS DE BOLA RECTAS EN PVC PN10 CON SISTEMA ANTIFRAUDE MAGNÉTICO

H 1/2" RACOR TELESCÓPICO 3/4" DN15

REF.	EUROS	UNID. DE EMBALAJE	PESO UNID.
PVC10006	5,61	80	0,152

Opcional con tornillo antifraude

H 1/2" RACOR TELESCÓPICO 3/4" DN15 CON TAPÓN DE BLOQUEO MAGNÉTICO

REF.	EUROS	UNID. DE EMBALAJE	PESO UNID.
PVC10106	7,75	80	0,152

M 1/2" P.E. DN16-20

REF.	EUROS	UNID. DE EMBALAJE	PESO UNID.
PVC10004	7,61	80	0,194

Opcional con tornillo antifraude

H 1/2" P.E. DN16-20

REF.	EUROS	UNID. DE EMBALAJE	PESO UNID.
PVC10005	5,50	80	0,150

Opcional con tornillo antifraude

H 1/2" P.E. DN16-20 RACOR DE NYLON 3/4" - 7/8"

REF.	EUROS	UNID. DE EMBALAJE	PESO UNID.
PVC10007	6,64	80	0,174

Opcional con tornillo antifraude

PARA VÁLVULAS CON TORNILLO ANTIFRAUDE SUMAR LA REF. BTR101098 DE LA PÁGINA 56

Revisión B

ALOJAMIENTO CONTADORES

Revisión B

23/01

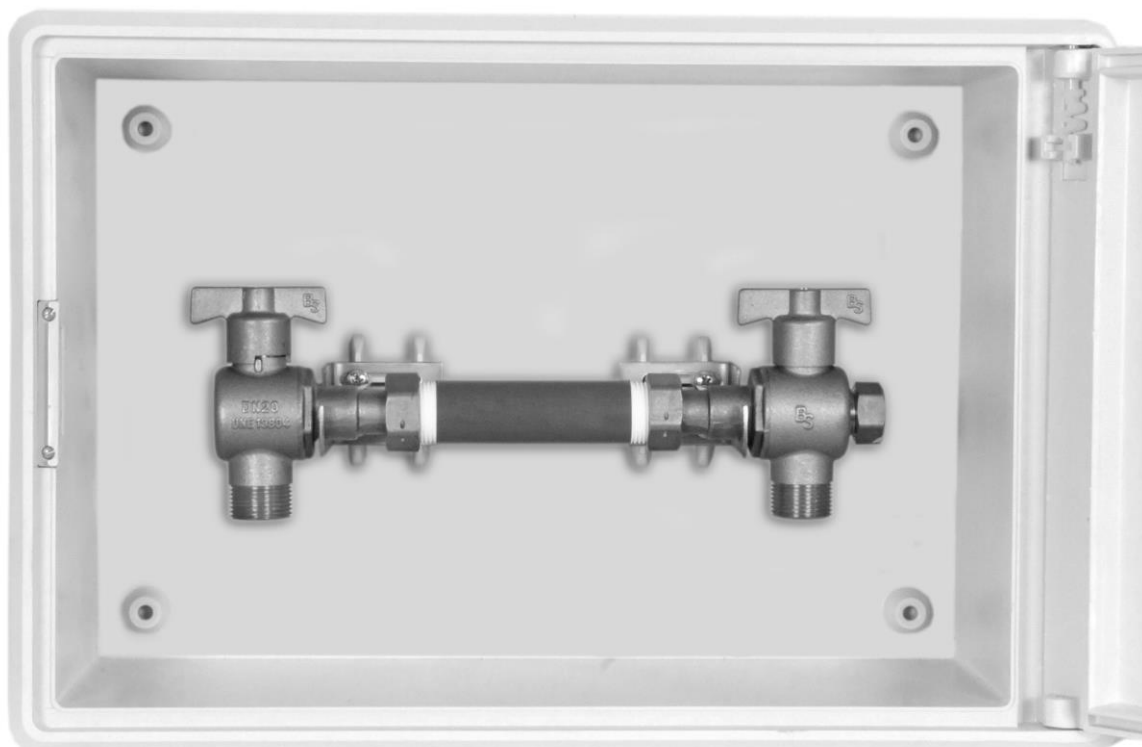

Revisión B

ÍNDICE

PAG. 75.....	ARMARIOS PARA CONTADORES DOMICILIARIOS
PAG. 76-77.....	ARMARIOS MONTADOS CON VÁLVULAS
PAG. 78.....	ARMARIOS ESPECIALES PARA CONTADORES
PAG. 79.....	ALOJAMIENTO PARA CONTADORES DE AGUA PPR
PAG. 80.....	KIT DE CONEXIÓN PARA CAJA DE SUELO
PAG. 81.....	SISTEMAS DE CORTE A DISTANCIA DE SUMINISTROS DE AGUA
PAG. 82.....	TAPÓN ANTIFRAUDE
PAG. 83.....	PUERTAS Y REGISTROS ALUMINIO
PAG. 84-86.....	ACCESORIOS ARMARIOS
PAG. 87-89.....	RACORES LATÓN PARA P.E.
PAG. 90.....	REDUCTORES DE PRESIÓN
PAG. 91.....	FILTROS
PAG. 92.....	MANÓMETROS

ALOJAMIENTO PARA CONTADORES AGUA



PUERTA CON MARCO DE POLIÉSTER SIN MIRILLA 346x450

REF.	EUROS	UNID. DE EMBALAJE	PESO UNID.
530001	45,13	4	1,300

PUERTA CON MARCO DE POLIÉSTER CON MIRILLA 346x450

REF.	EUROS	UNID. DE EMBALAJE	PESO UNID.
530002	48,07	4	1,300



ARMARIO DE POLIÉSTER PARA CONTADOR 312x428x190 SIN MIRILLA

REF.	EUROS	UNID. DE EMBALAJE	PESO UNID.
530101	55,17	1	3,000

ARMARIO DE POLIÉSTER PARA CONTADOR 312x428x190 CON MIRILLA

REF.	EUROS	UNID. DE EMBALAJE	PESO UNID.
530103	57,38	1	3,000

ARMARIO DE POLIÉSTER 312x428x190 SIN MIRILLA Y CON CERRADURA METÁLICA

REF.	EUROS	UNID. DE EMBALAJE	PESO UNID.
530116	56,61	1	3,000

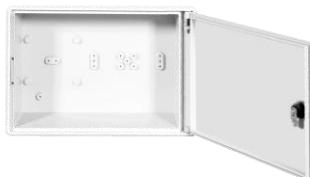

ARMARIO DE POLIÉSTER PARA CONTADOR 312x428x120 SIN MIRILLA

REF.	EUROS	UNID. DE EMBALAJE	PESO UNID.
530211	52,53	1	2,400

ARMARIO DE POLIÉSTER PARA CONTADOR 312x428x120 CON MIRILLA

REF.	EUROS	UNID. DE EMBALAJE	PESO UNID.
530207	55,14	1	2,400

PARA ARMARIOS CON CERRADURA METÁLICA CONSULTAR PRECIOS

CON SISTEMA CANDADO



ARMARIO DE POLIÉSTER PARA CONTADOR 312x428x120 CON MIRILLA

REF.	EUROS	UNID. DE EMBALAJE	PESO UNID.
530206	58,82	1	2,400

ARMARIO DE POLIÉSTER PARA CONTADOR 312x428x120 SIN MIRILLA

REF.	EUROS	UNID. DE EMBALAJE	PESO UNID.
530213	56,20	1	2,400

Revisión B

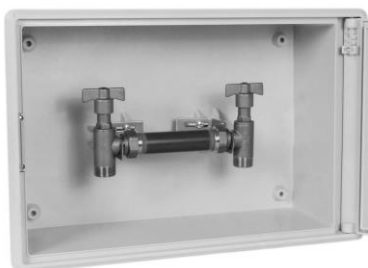
ARMARIOS POLIÉSTER EQUIPADOS CON VÁLVULAS BS

ARMARIO POLIÉSTER 312x428x120 S/M MONTADO CON ANCLAJES A/INOX.
VÁLVULA ENTRADA-SALIDA DN 13-15 BS Y CAÑO LIBRE

REF.	EUROS	UNID. DE EMBALAJE	PESO UNID.
535154	79,77	1	3,700

ARMARIO POLIÉSTER 312x428x120 S/M MONTADO CON ANCLAJES A/INOX.
VÁLVULA ENTRADA-SALIDA DN 20 BS Y CAÑO LIBRE

REF.	EUROS	UNID. DE EMBALAJE	PESO UNID.
535155	101,90	1	3,900

ARMARIO POLIÉSTER 312x428x120 S/M MONTADO CON ANCLAJES A/INOX.
VÁLVULA ENTRADA-SALIDA DN 13-15 P-E BS Y CAÑO LIBRE

REF.	EUROS	UNID. DE EMBALAJE	PESO UNID.
535156	92,55	1	4,000

ARMARIO POLIÉSTER 312x428x120 S/M MONTADO CON ANCLAJES A/INOX.
VÁLVULA ENTRADA-SALIDA DN 20 P-E BS Y CAÑO LIBRE

REF.	EUROS	UNID. DE EMBALAJE	PESO UNID.
535157	108,81	1	4,100

PARA OTRAS COMBINACIONES CONSULTAR

Revisión B

ARMARIOS POLIÉSTER EQUIPADOS CON VÁLVULAS ESFERA

ARMARIO POLIÉSTER 312x428x120 S/M MONTADO CON ANCLAJES A/INOX.
VÁLVULA ENTRADA-SALIDA DN 13-15 ESFERA Y CAÑO LIBRE

REF.	EUROS	UNID. DE EMBALAJE	PESO UNID.
535150	77,46	1	3,600

ARMARIO POLIÉSTER 312x428x120 S/M MONTADO CON ANCLAJES A/INOX.
VÁLVULA ENTRADA-SALIDA DN 20 ESFERA Y CAÑO LIBRE

REF.	EUROS	UNID. DE EMBALAJE	PESO UNID.
535151	98,11	1	3,900

ARMARIO POLIÉSTER 312x428x120 S/M MONTADO CON ANCLAJES A/INOX.
VÁLVULA ENTRADA-SALIDA DN 13-15 P-E ESFERA Y CAÑO LIBRE

REF.	EUROS	UNID. DE EMBALAJE	PESO UNID.
535152	94,11	1	4,000

ARMARIO POLIÉSTER 312x428x120 S/M MONTADO CON ANCLAJES A/INOX.
VÁLVULA ENTRADA-SALIDA DN 20 P-E ESFERA Y CAÑO LIBRE

REF.	EUROS	UNID. DE EMBALAJE	PESO UNID.
535153	113,06	1	4,150

PARA OTRAS COMBINACIONES CONSULTAR

Revisión B

ALOJAMIENTO PARA CONTADORES DE AGUA

**ARMARIO DE HORMIGÓN PARA ACOMETIDA INDIVIDUAL
CON PUERTA DE ALUMINIO 250x350**

REF.	EUROS	UNID. DE EMBALAJE	PESO UNID.
520002	194,77	1	50,000

**ARMARIO DE HORMIGÓN PARA ACOMETIDA INDIVIDUAL
CON PUERTA DE ALUMINIO 290x390**

REF.	EUROS	UNID. DE EMBALAJE	PESO UNID.
520003	197,89	1	50,000

EQUIPAMIENTO INTERIOR NO INCLUIDO

**ARMARIO DE HORMIGÓN PARA BATERÍA DE CONTADORES
DE 2 SERVICIOS CON PUERTA DE ALUMINIO 400x420**

REF.	EUROS	UNID. DE EMBALAJE	PESO UNID.
520101	244,42	1	58,000

**ARMARIO DE HORMIGÓN PARA BATERÍA DE CONTADORES
DE 3 SERVICIOS CON PUERTA DE ALUMINIO 600x400**

REF.	EUROS	UNID. DE EMBALAJE	PESO UNID.
520102	639,39	1	65,000

EQUIPAMIENTO INTERIOR NO INCLUIDO

ARMARIO DE POLIÉSTER 530x530x230

REF.	EUROS	UNID. DE EMBALAJE	PESO UNID.
530102	90,59	1	4,800

ARMARIO DE POLIÉSTER 530x700x230

REF.	EUROS	UNID. DE EMBALAJE	PESO UNID.
530109	109,16	1	14,300

ARMARIO DE POLIÉSTER 750x750x300

REF.	EUROS	UNID. DE EMBALAJE	PESO UNID.
530106	488,52	1	18,600

ARMARIO DE POLIÉSTER 1000x750x300

REF.	EUROS	UNID. DE EMBALAJE	PESO UNID.
530110	543,25	1	21,200

Revisión B

ALOJAMIENTO PARA CONTADORES DE AGUA



CAJA DE SUELO EN PPR 329x162x160

REF.	EUROS	UNID. DE EMBALAJE	PESO UNID.
APM542003	28,49	1	0,800

CONTADOR Y KIT DE CONEXIÓN NO INCLUIDOS. ANCLAJES INCLUIDOS



CAJA DE SUELO EN PPR CON DOS COMPARTIMENTOS 372x224x175 TAPAS POLIPROPILENO CON MIRILLA

REF.	EUROS	UNID. DE EMBALAJE	PESO UNID.
APM542002	36,40	1	1,000

PARA LLAVE DE APERTURA VER PÁGINA 73

CONTADOR Y KIT DE CONEXIÓN NO INCLUIDOS



CAJA DE SUELO DE FUNDICIÓN DÚCTIL CON KIT DE CONEXIÓN DE ENTRADA Y SALIDA PARA CONTADOR DE 110 LONG.

REF.	EUROS	UNID. DE EMBALAJE	PESO UNID.
CTR00110	64,76	1	6,888

CAJA DE SUELO DE FUNDICIÓN DÚCTIL CON KIT DE CONEXIÓN DE ENTRADA Y SALIDA PARA CONTADOR DE 115 LONG.

REF.	EUROS	UNID. DE EMBALAJE	PESO UNID.
CTR00115	76,26	1	6,920

ARQUETA DE FUNDICIÓN VACÍA

REF.	EUROS	UNID. DE EMBALAJE	PESO UNID.
CTR00001	34,75	1	6,040

*Hasta fin de existencias

Revisión B

KIT DE CONEXIÓN PARA CAJA DE SUELO

KIT DE CONEXIÓN ENTRADA Y SALIDA CON VÁLVULAS DE PVC 1/2"



REF.	CONEXIÓN	EUROS	UNID. DE EMBALAJE	PESO UNID.
PVC10003-K	PPR	10,30	1	0,150
LAT10003-K	LATÓN	19,28	1	0,227

KIT DE CONEXIÓN PARA REF.APM542003 – APM542002

KIT DE CONEXIÓN ENTRADA Y SALIDA CON VÁLVULAS DE LATÓN 1/2"



REF.	CONEXIÓN	EUROS	UNID. DE EMBALAJE	PESO UNID.
PVC10006-K	PPR	29,82	1	0,152
LAT10006-K	LATÓN	39,51	1	0,279

KIT DE CONEXIÓN PARA REF.APM542003 – APM542002
VÁLVULA ENTRADA CON SISTEMA ANTIFRAUDE MAGNÉTICO

KIT DE CONEXIÓN ENTRADA CON CUADRADILLO 30x30 Y SALIDA CON VÁLVULAS DE LATÓN 1/2"



REF.	CONEXIÓN	EUROS	UNID. DE EMBALAJE	PESO UNID.
LAT10007-K	LATÓN	33,20	1	0,289

KIT DE CONEXIÓN PARA REF.APM542001
VÁLVULA ENTRADA CON SISTEMA ANTIFRAUDE MAGNÉTICO

KIT DE CONEXIÓN ENTRADA Y SALIDA DN 15 3/4"



REF.	EUROS	UNID. DE EMBALAJE	PESO UNID.
CTRKIT01	37,07	2	0,310

*Hasta fin de existencias

KIT VÁLVULAS PARA REF.CTR00001

Revisión B

SISTEMA INALÁMBRICO DE CORTE A DISTANCIA DE SUMINISTRO DE AGUA



REF.	EUROS	UNID. EMBALAJE	PESO UNID.
APM552001	772,68	1	4,800

MANDO A DISTANCIA DEL SISTEMA INALÁMBRICO



REF.	EUROS	UNID. EMBALAJE	PESO UNID.
APM552002	901,80	1	0,756

SISTEMA DE CORTE ANTIFRAUDE MAGNÉTICO



MEDIDA	REF.	EUROS	UNID. DE EMBALAJE	PESO UNID.
1/2"	APM552003	46,69	1	1,074
3/4"	APM552013	51,81	1	1,178
1"	APM552023	66,11	1	1,421
1 1/4"	APM552033	80,91	1	1,764
1 1/2"	APM552043	103,22	1	2,437
2"	APM552053	129,84	1	3,263

LLAVE DE ALLEN 8mm LONG.188x43



MEDIDA	REF.	EUROS	UNID. DE EMBALAJE	PESO UNID.
8mm	10034360	6,04	1	0.096

LLAVE DEL SISTEMA DE CORTE ANTIFRAUDE MAGNÉTICO



MEDIDA	REF.	EUROS	UNID. DE EMBALAJE	PESO UNID.
1/2"	APM552103	63,67	1	0,613
3/4" - 1" - 1 1/4"	APM552113	65,80	1	0,643
1 1/2" - 2"	APM552143	73,66	1	0,683

ALARGADERA LLAVE DEL SISTEMA DE CORTE ANTIFRAUDE MAGNÉTICO



REF.	EUROS	UNID. DE EMBALAJE	PESO UNID.
APM552203	51,24	1	0,542

TAPÓN ANTIFRAUDE HEMBRA CON FUNDA GIRATORIA ROSCA IZQUIERDA



MEDIDA	REF.	EUROS	UNID. DE EMBALAJE	PESO UNID.
21,8	SAAB0001	5,99	1	0,147
3/4"	SAAB0002	6,03	1	0,151
1"	SAAB0003	9,23	1	0,248

COMPLETAR PIDIENDO TAPÓN GIRATORIO. VEASE PÁGINA 56 REF. BTR101090

TAPÓN ANTIFRAUDE MACHO ROSCA DERECHA



MEDIDA	REF.	EUROS	UNID. DE EMBALAJE	PESO UNID.
1/2"	AV000017	3,43	1	0,081
3/4"	AV000016	3,82	1	0,098
7/8"	AV000018	4,17	1	0,112
1"	AV000019	5,13	1	0,143

COMPLETAR PIDIENDO TAPÓN GIRATORIO. VEASE PÁGINA 56 REF. BTR101090

DISPOSITIVO REDUCTOR DE CAUDAL



MEDIDA	REF.	EUROS	UNID. DE EMBALAJE	PESO UNID.
DN15	DRC15BS	39,60	1	0,340
DN20	DRC20BS	43,20	1	0,407
DN25	DRC25BS	46,80	1	0,585

LLAVE PARA DISPOSITIVO REDUCTOR DE CAUDAL



REF.	EUROS	UNID. DE EMBALAJE	PESO UNID.
BTR101080	9,50	1	0,097

Revisión B

PUERTAS Y REGISTROS DE ALUMINIO

PUERTA CON MARCO	REF.	EUROS	UNID. EMBALAJE	PESO UNID.
ALUMINIO				
150x200	500001	16,58	10	0,850
200x320	500002	19,51	10	1,300
250x350	500003	23,05	10	1,500
250x500	500004	38,42	10	2,100
300x500	500009	36,75	10	1,700
290x390	500005	25,43	10	1,800
220x350	500006	17,58	10	1,400
400x420	500007	60,53	5	3,500
285x385	500010	35,09	10	1,400

MOD. CÓRDOBA



REGISTRO DE ALUMINIO	REF.	EUROS	UNID. EMBALAJE	PESO UNID.
200x200	801020	13,76	10	1,700
300x300	801030	34,21	10	1,900
400x400	801040	56,09	10	3,200



REGISTRO DE ALUMINIO PARA LLAVE DE CORTE	REF.	EUROS	UNID. EMBALAJE	PESO UNID.
200x200	502002	11,00	10	0,800



SUMIDERO ALUMINIO	REF.	EUROS	UNID. EMBALAJE	PESO UNID.
150x150	800015	10,09	10	0,600
200x200	800020	15,14	10	0,750
250x250	800025	21,13	10	1,050
300x300	800030	29,36	10	2,030
400x400	800040	53,87	10	2,800

TAPA DE REGISTRO POLIPROPILENO 18 x 18 PARA SISTEMA SUBTERRÁNEO

REF.	EUROS	UNID. EMBALAJE	PESO UNID.
00800018	7,00	1	0,250

ACCESORIOS PARA ARMARIOS

CERRADURA METÁLICA PARA PUERTA DE ALUMINIO

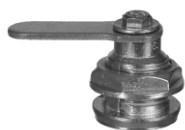

MODELO	REF.	EUROS	UNID. DE EMBALAJE	PESO UNID.
CUADRADILLO HEMBRA	500204	4,58	1	0,030
CUADRADILLO MACHO	500214	4,58	1	0,030
TRIANGULAR MACHO	500205	2,61	1	0,030
ALLEN	500220	4,58	1	0,030

LLAVE METÁLICA PARA PUERTA DE ALUMINIO

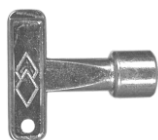

MODELO	REF.	EUROS	UNID. DE EMBALAJE	PESO UNID.
CUADRADILLO MACHO	500199	1,91	1	0,012
CUADRADILLO HEMBRA	500227	1,91	1	0,012
TRIANGULAR HEMBRA	500228	1,91	1	0,012
ALLEN	500223	1,91	1	0,012

CERRADURA TRIANGULAR

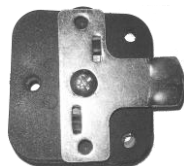

REF.	EUROS	UNID. DE EMBALAJE	PESO UNID.
502015	4,21	1	0,025

CERRADURA DE CUADRADILLO

REF.	EUROS	UNID. DE EMBALAJE	PESO UNID.
502012	4,21	1	0,025

LLAVE TRIANGULAR



REF.	EUROS	UNID. DE EMBALAJE	PESO UNID.
500201	1,32	1	0,008

LLAVE METÁLICA PARA ARQUETAS REF.APM542003-APM542001-APM542002



REF.	EUROS	UNID. DE EMBALAJE	PESO UNID.
00502113	2,85	1	0,056

Revisión B

ACCESORIOS PARA ARMARIOS



HASTA FIN DE EXISTENCIAS

CERRADURA METÁLICA TRIANGULAR 8mm

REF.	EUROS	UNID. DE EMBALAJE	PESO UNID.
502019	9,94	1	0,155

CERRADURA METÁLICA DE CUADRADILLO 8mm

REF.	EUROS	UNID. DE EMBALAJE	PESO UNID.
502018	9,94	1	0,155



JUEGO ANCLAJES ACERO INOXIDABLE PARA ARMARIO DE POLIÉSTER

REF.	EUROS	UNID. DE EMBALAJE	PESO UNID.
539903	8,42	1	0,26



AISLAMIENTO TÉRMICO PARA PUERTA DE POLIÉSTER 312x428

REF.	EUROS	UNID. DE EMBALAJE	PESO UNID.
997000	7,22	1	0,010

AISLAMIENTO TÉRMICO PARA CUBA 312x428x190

REF.	EUROS	UNID. DE EMBALAJE	PESO UNID.
997020	7,22	1	0,030

Revisión B

ACCESORIOS PARA ARMARIOS

COLECTOR ROSCADO DE 1" CON 2 SALIDAS PARA ARMARIO DE HORMIGÓN

REF.	EUROS	UNID. DE EMBALAJE	PESO UNID.
180001	45,25	1	1,300

COLECTOR ROSCADO DE 1" CON 3 SALIDAS PARA ARMARIO DE HORMIGÓN

REF.	EUROS	UNID. DE EMBALAJE	PESO UNID.
180002	51,88	1	1,700

CODO EMBRIDADO DOBLE BRIDA 2" GALVANIZADO

REF.	EUROS	UNID. DE EMBALAJE	PESO UNID.
180003	70,19	1	6,000

CODO EMBRIDADO DOBLE BRIDA 2 1/2" GALVANIZADO

REF.	EUROS	UNID. DE EMBALAJE	PESO UNID.
180004	87,52	1	7,200

CODO EMBRIDADO DOBLE BRIDA 3" GALVANIZADO

REF.	EUROS	UNID. DE EMBALAJE	PESO UNID.
180005	100,22	1	9,300

CODO EMBRIDADO DOBLE BRIDA 4" GALVANIZADO

REF.	EUROS	UNID. DE EMBALAJE	PESO UNID.
180006	114,13	1	11,000

Revisión B

RACORES DE LATÓN PARA P-E

MANGUITO



MEDIDAS	REF.	EUROS	UNID. EMBALAJE	PESO UNID.
20x20	770001	10,11	10	0,150
25x25	770002	12,16	10	0,200
32x32	770003	18,51	10	0,320
40x40	770004	35,97	10	0,450
50x50	770005	53,11	10	0,630
63x63	770006	74,84	5	0,920
75x75	770007	113,61	1	2,350

RACOR ROSCA MACHO



MEDIDAS	REF.	EUROS	UNID. EMBALAJE	PESO UNID.
20x1/2"	770008	6,08	10	0,090
25x3/4"	770009	7,69	10	0,130
32x1"	770010	11,00	10	0,200
40x1 1/4"	770011	21,45	10	0,300
50x1 1/2"	770012	28,38	10	0,400
63x2"	770013	42,05	5	0,540

RACOR ROSCA HEMBRA



MEDIDAS	REF.	EUROS	UNID. EMBALAJE	PESO UNID.
20x1/2"	770015	5,94	10	0,090
25x3/4"	770016	7,51	10	0,130
32x1"	770017	11,20	10	0,190
40x1 1/4"	770018	19,57	10	0,295
50x1 1/2"	770019	29,44	10	0,390
63x2"	770020	41,43	5	0,530

RACORES DE LATÓN PARA P-E

CODO DOS BOCAS IGUALES



MEDIDAS	REF.	EUROS	UNID. EMBALAJE	PESO UNID.
20x20	770022	12,95	10	0,170
25x25	770023	14,82	10	0,260
32x32	770024	23,40	10	0,360
40x40	770025	43,38	10	0,630
50x50	770026	60,18	10	0,850
63x63	770027	85,06	5	1,300

"T" MIXTA



MEDIDAS	REF.	EUROS	UNID. EMBALAJE	PESO UNID.
20x1/2"	770047	13,63	10	0,180
25x3/4"	770048	16,74	10	0,260
32x1"	770049	25,86	10	0,390
40x1 1/4"	770050	49,12	10	0,670
50x1 1/2"	770051	71,97	5	0,980
63x2"	770052	94,30	5	1,300
75x2 1/2"	770053	129,51	1	3,400

Revisión B

RACOR CODO MACHO



MEDIDAS	REF.	EUROS	UNID. EMBALAJE	PESO UNID.
20x1/2"	770028	10,04	10	0,110
25x3/4"	770029	11,75	10	0,150
32x1"	770030	17,66	10	0,255
40x1 1/4"	770031	32,28	10	0,430
50x1 1/2"	770032	46,79	10	0,540
63x2"	770033	68,41	5	0,985

RACORES DE LATÓN PARA P-E

RACOR CODO HEMBRA



MEDIDAS	REF.	EUROS	UNID. EMBALAJE	PESO UNID.
20x1/2"	770034	9,91	10	0,120
25x3/4"	770035	11,72	10	0,170
32x1"	770036	17,80	10	0,230
40x1 1/4"	770037	32,58	10	0,360
50x1 1/2"	770038	44,10	10	0,640
63x2"	770039	72,75	5	1,050

"T" TRES BOCAS IGUALES



MEDIDAS	REF.	EUROS	UNID. EMBALAJE	PESO UNID.
20x20x20	770040	18,07	10	0,220
25x25x25	770041	20,90	10	0,305
32x32x32	770042	31,08	10	0,487
40x40x40	770043	58,34	10	0,850
50x50x50	770044	84,98	10	1,050
63x63x63	770045	126,13	5	1,530
75x75x75	770046	173,85	1	4,900

CODO PLACA



MEDIDAS	REF.	EUROS	UNID. EMBALAJE	PESO UNID.
1/2"x20	770060	12,67	10	0,180
3/4"x25	770061	14,58	10	0,260

MANGUITO REPARACIÓN



MEDIDAS	REF.	EUROS	UNID. EMBALAJE	PESO UNID.
20x20	770062	17,83	10	0,290
25x25	770063	21,45	10	0,400
32x32	770064	31,08	10	0,580
40x40	770065	49,53	10	0,765

Revisión B

REDUCTORES DE PRESIÓN

REDUCTOR DE PRESIÓN SERIE R3



PN	PULGADAS	REF.	EUROS	UNID. EMBALAJE	PESO UNID.
PN 15	1/2"	780116	17,30	50	0,350
PN 15	3/4"	780117	18,13	50	0,390

REDUCTOR DE PRESIÓN A PISTÓN PN25 ASIENTO A/INOX Y TOMA DE MANÓMETRO



PN	PULGADAS	REF.	EUROS	UNID. EMBALAJE	PESO UNID.
PN 25	1/2"	780001	30,96	1	1,360
PN 25	3/4"	780002	42,62	1	2,255
PN 25	1"	780003	54,26	1	3,265
PN 25	1 1/4"	780004	100,40	1	5,090
PN 25	1 1/2"	780005	110,87	1	9,120
PN 25	2"	780006	167,91	1	1,170

REDUCTOR DE PRESIÓN PN40 CON CÁMARA DE COMPENSACIÓN Y TOMA DE MANÓMETRO



PN	PULGADAS	REF.	EUROS	UNID. EMBALAJE	PESO UNID.
PN 40	2"	780012	644,85	1	11,000
PN 40	2 1/2"	780013	1.480,00	1	13,000
PN 40	3"	780014	1.960,84	1	17,000
PN 40	4"	780015	4.759,31	1	25,000

Revisión B

FILTROS DE LATÓN
FILTRO PARA RECOGIDA DE IMPUREZAS

PN	PULGADAS	REF.	EUROS	UNID. EMBALAJE	PESO UNID.
PN 16 Precintable	1/2"	790001	5,17	10	0,115
PN 16	3/4"	790002	6,82	10	0,126
PN 16	1"	790003	9,29	10	0,320
PN 16	1 1/4"	790004	18,95	5	0,515
PN 16	1 1/2"	790005	24,68	5	0,665
PN 16	2"	790006	52,53	2	1,195

FILTRO AUTOLIMPIANTE PARA AGUA MALLA ACERO INOX. 100 MICRAS

PN	PULGADAS	REF.	EUROS	UNID. EMBALAJE	PESO UNID.
PN 25	3/4"	790010	82,22	15	1,475
PN 25	1"	790011	102,69	10	1,779
PN 25	1 1/4"	790012	104,19	10	1,779
PN 25	1 1/2"	790013	132,44	5	2,941
PN 25	2"	790014	135,75	5	2,941

Revisión B

MANÓMETROS



MANÓMETRO 0-16 BAR Ø 63

PULGADAS	REF.	EUROS	UNID. DE EMBALAJE	PESO UNID.
1/4"	790015	6,11	1	0,063

MANÓMETRO 0-25 BAR Ø 63

PULGADAS	REF.	EUROS	UNID. DE EMBALAJE	PESO UNID.
1/4"	790016	6,11	1	0,063

MANÓMETRO DE GLICERINA 0-6

PULGADAS	REF.	EUROS	UNID. DE EMBALAJE	PESO UNID.
1/4"	790018	12,95	1	0,213

MANÓMETRO DE GLICERINA 0-10

PULGADAS	REF.	EUROS	UNID. DE EMBALAJE	PESO UNID.
1/4"	790019	12,95	1	0,220

Revisión B

CONTADORES

Revisión B

23/01



REVISION B

ÍNDICE

PAG. 95-97..... CONTADORES USO DOMÉSTICO

PAG. 98..... CONJUNTOS MONTADOS

PAG. 99-100..... CONTADORES DE CHORRO MÚLTIPLE Y VOLUMÉTRICOS

PAG. 101..... CONTADORES WOLTMAN

PAG. 102-106..... ACCESORIOS PARA CONTADOR

Revisión B

MOD. SJ-SDC PLUS DN15-20 CONTADOR CHORRO ÚNICO R100 CUERPO LATÓN CON PREDISPOSICIÓN HOMOLOGADO



MODELO	30°C/90°C	DIÁMETRO	LONGITUD	REF.	EUROS	UD.EMBALAJE	PESO UNID.
SJ-SDC-PLUS	A/F	1/2" 13mm	115 mm	NW680111	27,74	20	0,460
SJ-SDC-PLUS	A/F	1/2" 15mm	115 mm	NW680110	26,33	20	0,430
SJ-SDC-PLUS	A/C	1/2" 15mm	115 mm	NW640007	30,82	20	0,430
SJ-SDC-PLUS	A/F	3/4" 20mm	130 mm	NW680112	37,84	20	0,540
SJ-SDC-PLUS	A/C	3/4" 20mm	130 mm	NW640006	38,74	20	0,540

VERIFICACIÓN DE FÁBRICA Y RACORES INCLUIDOS

MOD. SJ-SDC-PLUS DN15-20 CONTADOR CHORRO ÚNICO R160 CUERPO LATÓN CON PRE-DISPOSICIÓN HOMOLOGADO



MODELO	30°C	DIÁMETRO	LONGITUD	REF.	EUROS	UD.EMBALAJE	PESO UNID.
SJ-SDC-PLUS	A/F	1/2" 13mm	115 mm	NW680115	30,13	20	0.460
SJ-SDC-PLUS	A/F	1/2" 15mm	115 mm	NW680008	28,80	20	0.430
SJ-SDC-PLUS	A/F	3/4" 20mm	130 mm	NW680309	38,84	20	0.540

VERIFICACIÓN DE FÁBRICA Y RACORES INCLUIDOS

Revisión B

MOD. SJ-SDC-D3 DN15 CONTADOR CHORRO ÚNICO R100 CUERPO COMPOSITE CON PREDISPOSICIÓN HOMOLOGADO



MODELO	30°C	DIÁMETRO	LONGITUD	REF.	EUROS	UD. EMBALAJE	PESO UNID.
SJ-SDC	A/F	1/2" 15mm	115 mm	NW680101	23,96	20	0,425

VERIFICACIÓN DE FÁBRICA Y RACORES INCLUIDOS

MOD. SJ-SDC-PLUS DN15 CONTADOR CHORRO ÚNICO R160 CUERPO COMPOSITE CON PRE-DISPOSICIÓN HOMOLOGADO



MODELO	30°C	DIÁMETRO	LONGITUD	REF.	EUROS	UD. EMBALAJE	PESO UNID.
SJ-SDC-PLUS	A/F	1/2" 15mm	115 mm	NW680003	27,86	20	0,475

VERIFICACIÓN DE FÁBRICA Y RACORES INCLUIDOS

Revisión B

MOD. LEXUS-LXSG CONTADOR 8 RODILLOS ESFERA SECA R80 NO HOMOLOGADO



MODELO	30°C / 90°C	DIÁMETRO	LONGITUD	REF.	EUROS	UNID. EMBALAJE	PESO UNID.
LXSG8R	A/F	1/2" 15mm	110 mm	660055	18,91	40	0,458

VERIFICACIÓN Y RACORES INCLUIDOS

MOD. SJSDC R100 DN15/20 A/F-A/C

CONTADOR 8 RODILLOS ESFERA SECA CON EMISOR DE IMPULSOS

HOMOLOGADO



MODELO	30°C / 90°C	DIÁMETRO	LONGITUD	REF.	EUROS	UD. EMBALAJE	PESO UNID.
SJ-SDC-PLUS	A/F	1/2" 13mm	115 mm	NW621107	37,20	20	0,480
SJ-SDC-PLUS	A/F	1/2" 15mm	115 mm	NW621103	35,94	20	0,450
SJ-SDC-PLUS	A/C	1/2" 15mm	115 mm	NW621104	40,49	20	0,450
SJ-SDC-PLUS	A/F	3/4" 20mm	130 mm	NW621105	48,12	20	0,510
SJ-SDC-PLUS	A/C	3/4" 20mm	130 mm	NW621106	49,10	20	0,510

VALOR DE IMPULSOS 1P-1-1P-10

VERIFICACIÓN Y RACORES INCLUIDOS

MOD. SJSDC PLUS R160 DN 15 A/F

CONTADOR 8 RODILLOS ESFERA SECA CON EMISOR DE IMPULSOS

HOMOLOGADO



MODELO	30°C	DIÁMETRO	LONGITUD	REF.	EUROS	UD. EMBALAJE	PESO UNID.
SJ-SDC PLUS	A/F	1/2" 13mm	115 mm	NW641104	38,68	20	0,480
SJ-SDC PLUS	A/F	1/2" 15mm	115 mm	NW641103	37,35	20	0,460
SJ-SDC PLUS	A/F	3/4" 20mm	130 mm	NW641105	41,73	20	0,530

VALOR DE IMPULSOS 1P-1-1P-10

VERIFICACIÓN Y RACORES INCLUIDOS

Revisión B

CONJUNTOS MONTADOS PARA LECTURA DE AGUA CALIENTE SANITARIA



CONJUNTO CON VÁLVULAS ESFERA 1/2" – H RACOR 3/4" Y CONTADOR A/C DN 15			
REF.	EUROS	UNID. DE EMBALAJE	PESO UNID.
990205	49,19	10	1,000
CONJUNTO CON VÁLVULAS ESFERA 3/4" – H RACOR 3/4" Y CONTADOR A/C DN 15			
REF.	EUROS	UNID. DE EMBALAJE	PESO UNID.
990207	63,27	10	1,220
CONJUNTO CON VÁLVULAS ESFERA 3/4" – H RACOR 1" Y CONTADOR A/C DN 20			
REF.	EUROS	UNID. DE EMBALAJE	PESO UNID.
990208	74,71	10	1,470



CONJUNTO CON VÁLVULAS ESFERA 1/2" – H RACOR 3/4" Y CONTADOR IMPULSOS A/C DN 15			
REF.	EUROS	UNID. DE EMBALAJE	PESO UNID.
990209	57,33	10	1,016
CONJUNTO CON VÁLVULAS ESFERA 3/4" – H RACOR 3/4" Y CONTADOR IMPULSOS A/C DN 15			
REF.	EUROS	UNID. DE EMBALAJE	PESO UNID.
990214	71,82	10	1,236
CONJUNTO CON VÁLVULAS ESFERA 3/4" – H RACOR 1" Y CONTADOR IMPULSOS A/C DN 20			
REF.	EUROS	UNID. DE EMBALAJE	PESO UNID.
990217	83,95	10	1,486

CONJUNTOS MONTADOS CON SOPORTE DE FIJACIÓN PARA LECTURA DE AGUA FRÍA Y CALIENTE SANITARIA



CONJUNTO CON VÁLVULAS ESFERA 3/4" M – RACOR 3/4" Y CONTADOR A/F Y A/C DN 15			
REF.	EUROS	UNID. DE EMBALAJE	PESO UNID.
990201	153,74	1	2,000
CONJUNTO CON VÁLVULAS ESFERA 3/4" M – RACOR 1" Y CONTADOR A/F Y A/C DN 20			
REF.	EUROS	UNID. DE EMBALAJE	PESO UNID.
990211	178,83	1	2,250

PARA OTRAS COMBINACIONES CONSULTAR MONTAJE ESTANDAR CON CONEXIÓN DE ENTRADA POR LA IZQUIERDA

Revisión B

CONTADORES CHORRO MÚLTIPLE R80/R100

MOD. KVS

CONTADOR CHORRO MÚLTIPLE CUADRANTE SECO A/F – R80/R100

HOMOLOGADO



MODELO	A/F 30°C	DIÁMETRO	LONGITUD	REF.	EUROS	UNID. EMBALAJE	PESO UNID.
KVS	3 M3	1/2" 15mm	165 mm	660029	41,44	20	1,900
KVS	5 M3	3/4" 20mm	190 mm	660030	56,01	20	2,500
KVS	7 M3	1" 25mm	260 mm	660031	81,35	10	2,700
KVS	12 M3	1 1/4" 30mm	260 mm	660032	99,59	10	2,800
KVS	20 M3	1 1/2" 40mm	300 mm	660033	164,71	5	5,100
KVS	30 M3	2" 50mm	300 mm	660034	207,94	4	7,400

INCREMENTO PARA R160: 1,80 EUROS

RACORES INCLUIDOS

VERIFICACIÓN NO INCLUIDA

MOD. MJ-SDC

CONTADOR CHORRO MÚLTIPLE CUADRANTE SECO A/C – R100

HOMOLOGADO



MODELO	A/C 90°C	DIÁMETRO	LONGITUD	REF.	EUROS	UNID. EMBALAJE	PESO UNID.
MJ-SDC	3 M3	1/2" 15mm	165 mm	660398	55,60	20	1,900
MJ-SDC	5 M3	3/4" 20mm	190 mm	660399	63,72	20	2,500
MJ-SDC	7 M3	1" 25mm	260 mm	660400	106,76	10	2,700
MJ-SDC	12 M3	1 1/4" 30mm	260 mm	660401	131,44	10	2,800
MJ-SDC	20 M3	1 1/2" 40mm	300 mm	660402	260,47	5	5,100
MJ-SDC	30 M3	2" 50mm	300 mm	660403	280,65	4	7,400

RACORES INCLUIDOS

MOD. KVS

CONTADOR CHORRO MÚLTIPLE CON EMISOR DE IMPULSOS A/F - R80/R100

HOMOLOGADO



MODELO	A/F 30°C	DIÁMETRO	LONGITUD	REF.	EUROS	UNID. EMBALAJE	PESO UNID.
KVS	3 M3	1/2" 15mm	165 mm	661129	51,53	20	1,900
KVS	5 M3	3/4" 20mm	190 mm	661130	61,02	20	2,500
KVS	7 M3	1" 25mm	260 mm	661131	91,24	10	2,700
KVS	12 M3	1 1/4" 30mm	260 mm	661132	110,00	10	2,800
KVS	20 M3	1 1/2" 40mm	300 mm	661133	175,47	5	5,100
KVS	30 M3	2" 50mm	300 mm	661134	214,60	4	7,400

VALOR DE IMPULSOS 1P-1-1P-10

RACORES INCLUIDOS

VERIFICACIÓN NO INCLUIDA

MOD. MJ-SDC

CONTADOR CHORRO MÚLTIPLE CON EMISOR DE IMPULSOS A/C – R100

HOMOLOGADO



MODELO	A/C 90°C	DIÁMETRO	LONGITUD	REF.	EUROS	UNID. EMBALAJE	PESO UNID.
MJ-SDC	3 M3	1/2" 15mm	165 mm	661398	107,65	20	1,900
MJ-SDC	5 M3	3/4" 20mm	190 mm	661399	132,25	20	2,500
MJ-SDC	7 M3	1" 25mm	260 mm	661400	148,10	10	2,700
MJ-SDC	12 M3	1 1/4" 30mm	260 mm	661401	200,64	10	2,800
MJ-SDC	20 M3	1 1/2" 40mm	300 mm	661402	304,43	5	5,100
MJ-SDC	30 M3	2" 50mm	300 mm	661403	345,13	4	7,400

VALOR DE IMPULSOS 1P-10

RACORES INCLUIDOS

Revisión B

MOD. NWM PD-SDC E8 DN15 CONTADOR VOLUMÉTRICO DE PISTÓN ROTATIVO R200 CUERPO COMPOSITE ESFERA SECA CON PRE-DISPOSICIÓN

HOMOLOGADO



MODELO	A/F 30°C	DIÁMETRO	LONGITUD	REF.	EUROS	UNID. EMBALAJE	PESO UNID.
NWM PD-SDC E8	Q3:2,5 M ³ /h	1/2" 15mm	115 mm	NW710101	38,00	20	0,750
NWM PD-SDC E8(*)	Q3:2,5 M ³ /h	1/2" 15mm	115 mm	NW710107	38,59	20	0,750

(*) Rosca diferencial 7/8" entrada - 3/4" salida

VERIFICACIÓN DE FÁBRICA Y RACORES INCLUIDOS

MOD. ASTRAL RTK

CONTADOR VOLUMÉTRICO CLASE R160 CON PISTÓN ROTATORIO R160 EN CUALQUIER POSICIÓN HOMOLOGADO



MODELO	50°C	DIÁMETRO	LONGITUD	REF.	EUROS	UNID. EMBALAJE	PESO UNID.
RTK	A/F	1/2" 15mm	110 mm	660065	57,78	10	0,370
RTK	A/F	3/4" 20mm	190 mm	660066	65,37	10	0,480

*Hasta fin de existencias

VERIFICACIÓN Y RACORES INCLUIDOS

MOD. PDLFC DN15-20

CONTADOR VOLUMÉTRICO R160/200 CUERPO COMPOSITE Y A.INOX CON PRE-DISPOSICIÓN

HOMOLOGADO



MODELO	A/F 30°C	DIÁMETRO	LONGITUD	REF.	EUROS	UD. EMBALAJE	PESO UNID.
PDLFC R160	Q3:2,5 M ³ /h	1/2" 15mm	115 mm	PDLFC1003	31,28	20	0,450
PDLFC R200	Q3:2,5 M ³ /h	1/2" 15mm	115 mm	PDLFC1007	32,84	20	0,450

VERIFICACIÓN Y RACORES INCLUIDOS

MOD. LXH DN15 CONTADOR VOLUMÉTRICO R160 CUERPO LATÓN CON PRE-DISPOSICIÓN



MODELO	A/F 30°C	DIÁMETRO	LONGITUD	REF.	EUROS	UD. EMBALAJE	PESO UNID.
LXH R160	Q3:2,5 M ³ /h	1/2" 15mm	115 mm	LXH10011	39,09	20	1,100

VERIFICACIÓN Y RACORES INCLUIDOS

Revisión B

**CONTADOR WOLTMAN DE TURBINA R80 AGUA FRÍA 30°
CON PREEQUIPO PARA EMISOR DE IMPULSOS MOD. WPH K30**

HOMOLOGADO



CAUDAL MAX. M ³ -HORA	DIÁMETRO	LONGITUD	REF.	EUROS	UNID. EMBALAJE	PESO UNID.
30 M ³	2" 50mm	200 mm	660046	308,57	1	12,000
50 M ³	2 1/2" 65mm	200 mm	660047	344,08	1	13,000
80 M ³	3" 80mm	225 mm	660048	351,41	1	15,000
120 M ³	4" 100mm	250 mm	660049	402,21	1	17,000
200 M ³	5" 125mm	250 mm	660050	482,49	1	19,000
300 M ³	6" 150mm	300 mm	660051	747,22	1	40,000
500 M ³	8" 200mm	350 mm	660052	949,06	1	55,000

VALOR DE IMPULSOS 1P-100

PARA EQUIPAMIENTO CON EMISOR IMPULSOS SUMAR REF. NW1060103 – PAG. 104

VERIFICACIÓN NO INCLUIDA

**CONTADOR WOLTMAN DE TURBINA R80 AGUA CALIENTE 120°
CON PREEQUIPO PARA EMISOR DE IMPULSOS MOD. WPH K30**

NO HOMOLOGADO



CAUDAL MAX. M ³ -HORA	DIÁMETRO	LONGITUD	REF.	EUROS	UNID. EMBALAJE	PESO UNID.
30 M ³	2" 50mm	200 mm	660077	382,26	1	9,900
50 M ³	2 1/2" 65mm	200 mm	660078	385,24	1	10,600
80 M ³	3" 80mm	225 mm	660079	463,44	1	13,300
120 M ³	4" 100mm	250 mm	660080	523,74	1	15,600

VALOR DE IMPULSOS 1P-100

PARA EQUIPAMIENTO CON EMISOR IMPULSOS SUMAR REF. NW1060103 – PAG. 104

Revisión B

VERIFICACIÓN PRIMITIVA WOLTMAN

MODELO	PULGADAS	REF.	PRECIO NETO
WPH K30	2"	1060007	15,03
WPH K30	2 1/2"	1060008	15,03
WPH K30	3"	1060009	15,03
WPH K30	4"	1060010	15,03
WPH K30	5"	1060011	15,03
WPH K30	6"	1060012	15,03
WPH K30	8"	1060013	15,03

VERIFICACIÓN PRIMITIVA CHORRO MÚLTIPLE

MODELO	DIAMETRO	REF.	PRECIO NETO
KVS	DN15	1060001	1,50
KVS	DN20	1060002	1,50
KVS	DN25	1060003	2,78
KVS	DN30	1060004	3,76
KVS	DN40	1060005	6,80
KVS	DN50	1060006	6,80

ACCESORIOS CONTADOR
RACOR CONTADOR EN LATÓN

Ø CONTADOR	REF.	EUROS	UNID. EMBALAJE	PESO UNID.
13mm 7/8" 1/2"	1040002	3,56	25	0,096
15mm 3/4" 1/2"	1040001	3,20	25	0,070
20mm 1" 3/4"	1040003	3,79	20	0,140
25mm 1 1/4" 1"	1040004	7,72	10	0,220
30mm 1 1/2" 1 1/4"	1040005	10,02	10	0,340
40mm 2" 1 1/2"	1040006	16,16	5	0,425
50mm 2 1/2" 2"	1040007	26,86	3	0,850

RACOR CONTADOR EN NYLON

Ø CONTADOR	REF.	EUROS	UNID. EMBALAJE	PESO UNID.
15mm 3/4" 1/2"	RNY1001	1,01	100	0,025
15mm 7/8" 1/2"	RNY1002	1,15	100	0,029

JUNTA RACOR CONTADOR

Ø RACOR	REF.	EUROS	UNID. DE EMBALAJE	PESO UNID.
7/8" 1/2"	1045001	0,18	25	0,006
3/4" 1/2"	1045002	0,13	25	0,005
1" 3/4"	1045003	0,17	25	0,010
1 1/4" 1"	1045004	0,25	25	0,020
1 1/2" 1 1/4"	1045005	0,33	25	0,030
2" 1 1/2"	1045006	0,34	25	0,030
2 1/2" 2"	1045007	0,59	25	0,070

ALARGADERA LATÓN M-H 3/4"

LONGITUD	REF.	EUROS	UNID. EMBALAJE	PESO UNID.
63 mm	99000094	5,66	10	0,108
83 mm	99000118	12,68	10	0,167

VENTA BAJO PEDIDO MÍNIMO DE 500 UNIDADES

Revisión B

ACCESORIOS CONTADOR

CAJA ANTIFRAUDE ESTANDAR MULTIDIÁMETRO



Ø CONTADOR	REF.	EUROS	UNID. EMBALAJE	PESO UNID.
13-15mm	1040704	1,09	25	0,002
20mm	1040705	1,16	25	0,002

PRECINTO MANUAL

NO PRECISA HERRAMIENTAS



REF.	EUROS	UNID. EMBALAJE	PESO UNID.
1040709	0,57	50	0,002

TENAZA PARA PRECINTO DE PLOMO



Ø	REF.	EUROS	UNID. EMBALAJE	PESO UNID.
11 mm	1040502	57,04	1	0,300
13 mm	1040503	64,55	1	0,400

PLOMO PARA PRECINTO



Ø PLOMO	REF.	EUROS	UNID. EMBALAJE	PESO UNID.
8 mm	1040701	0,063	410 (1kg. Aprox.)	0,002

ROLLO ALAMBRE INOXIDABLE PARA PRECINTO



ROLLO	REF.	EUROS	UNID. EMBALAJE	PESO UNID.
400 mts	1040801	63,90	1	1,22

Revisión B

ACCESORIOS CONTADOR
EMISOR IMPULSOS S20-130 VALOR IMPULSOS 1P-1L-1P-10L ADAPTABLE A LOS MODELOS PFU C, SFU Y SCU DN20

	REF.	EUROS	UNID. EMBALAJE	PESO UNID.
	1060120	16,63	1	0,050

EMISOR IMPULSOS K-10 PARA CONTADOR WOLTMAN Ø50 A 200 VALOR IMPULSOS 1P-100

	REF.	EUROS	UNID. EMBALAJE	PESO UNID.
	NW1060103	20,13	1	0,053

EMISOR IMPULSOS SJ-SDC VALOR IMPULSOS 1P-1L-1P-10L – KVS Y MJ-SDC 1P-10L-1P-100L

	REF.	EUROS	UNID. EMBALAJE	PESO UNID.
	NW1060100	15,66	1	0,050

Revisión B

ACCESORIOS CONTADOR

CONTADOR PROGRAMABLE CDI-10 220V SALIDA 24V-AC

	REF.	EUROS	UNID. EMBALAJE	PESO UNID.
	1060102	569,34	1	1,300

CONTADOR DE IMPULSOS H7 E C-N 24V-CA MOD. BLM CON SISTEMA PUESTA A CERO

	REF.	EUROS	UNID. EMBALAJE	PESO UNID.
	1060101	204,34	1	0,130

KIT CONTADOR S-110 DN15 DN20 + ELECTROVÁLVULA + CAJA ESTANCA PARA INSTALAR CON CONTADOR PROGRAMABLE CDI-10

	DN	REF.	EUROS	UNID. EMBALAJE	PESO UNID.
	15	1060115	267,22	1	1,100
	20	1060116	320,80	1	1,300

Revisión B

ACCESORIOS CONTADOR

ELECTROVÁLVULA AGUA N.C. 230V AC 50 HC – 24V 50-60 HC



DN	REF.	EUROS	UNID. EMBALAJE	PESO UNID.
15-1/2"	990172	87,11	1	0,450
20-3/4"	990173	113,66	1	0,622
25-1"	990174	135,44	1	1,200
32-1 1/2"	990175	282,69	1	2,900
40-1 1/2"	990176	299,97	1	3,300
50-2"	990177	351,53	1	3,900

ELECTROVÁLVULA AGUA N.A. 230V AC 50 HC – 24V 50-60 HC



DN	REF.	EUROS	UNID. EMBALAJE	PESO UNID.
15-1/2"	990181	106,36	1	0,450
20-3/4"	990182	123,22	1	0,622
25-1"	990183	147,53	1	1,200
32-1 1/2"	990184	259,42	1	2,900
40-1 1/2"	990185	323,43	1	3,300
50-2"	990186	407,73	1	3,900

Revisión B

CALEFACCIÓN

Revisión B

23/01



Revisión B

ÍNDICE

PAG. 109..... CONTADORES DE ENERGIA PARA USO DOMÉSTICO

PAG. 110-111..... MÓDULOS PARA CONTABILIZACIÓN

PAG. 112-114..... ACCESORIOS PARA CALEFACCIÓN

PAG. 115..... CONVERTIDORES DE SEÑAL

PAG. 116..... CENTRALITAS M-BUS Y MÓDEM



Revisión B

CONTADOR DE ENERGÍA TÉRMICA SENSORSTAR E Y CALCULADOR SENSORSTAR C

CONTADOR DE ENERGÍA MODELO SENSORSTAR E



DN mm	LONGITUD mm	CAUDAL MÁX. m ³ /h	CAUDAL NOM. m ³ /h	CAUDAL MÍN. l/h	TEMP. MÁX. °C	REF.	EUROS	UNID. EMBALAJE	PESO UNID.
15	110	3	1,5	30	90	660056	214,26	20	0,800
20	130	5	2,5	50	90	660057	225,99	20	0,950

RACORES INCLUIDOS

CONTADOR DE ENERGÍA MODELO SENSORSTAR E EQUIPADO CON M-BUS



DN mm	LONGITUD mm	CAUDAL MÁX. m ³ /h	CAUDAL NOM. m ³ /h	CAUDAL MÍN. l/h	TEMP. MÁX. °C	REF.	EUROS	UNID. EMBALAJE	PESO UNID.
15	110	3	1,5	30	90	660058	246,18	20	0,800
20	130	5	2,5	50	90	660059	256,50	20	0,950

RACORES INCLUIDOS

CONTADOR DE ENERGÍA MODELO SENSORSTAR E EQUIPADO CON M-BUS Y ENTRADA DE IMPULSOS



DN mm	LONGITUD mm	CAUDAL MÁX. m ³ /h	CAUDAL NOM. m ³ /h	CAUDAL MÍN. l/h	TEMP. MÁX. °C	REF.	EUROS	UNID. EMBALAJE	PESO UNID.
15	110	3	1,5	30	90	660053	268,00	20	0,800
20	130	5	2,5	50	90	660054	279,72	20	0,950

RACORES INCLUIDOS

CALCULADOR SENSORSTAR C BÁSICO CON SONDAS DE TEMPERATURA



VALOR IMPULSOS	TEMP. MÁX. °C	REF.	EUROS	UNID. EMBALAJE	PESO UNID.
VARIABLE	150	660060	331,01	1	0,310

CALCULADOR SENSORSTAR C CON M-BUS Y SONDAS DE TEMPERATURA



VALOR IMPULSOS	TEMP. MÁX. °C	REF.	EUROS	UNID. EMBALAJE	PESO UNID.
VARIABLE	150	660095	363,61	1	0,310

Revisión B

MÓDULOS COMPACTOS PARA LA CONTABILIZACIÓN DE LOS CONSUMOS TERMOSANITARIOS EQUIPADOS CON M-BUS Y ENTRADA DE IMPULSOS



**KIT CALEFACCIÓN SERIE BS-K80 CON ANCLAJES DE SUJECCIÓN
DN15 2 VÍAS CONEXIÓN 3/4" R/M**

REF.	EUROS	UNID. DE EMBALAJE	PESO UNID.
560080	341,72	1	2,900

**KIT CALEFACCIÓN SERIE BS-K80 CON ANCLAJES DE SUJECCIÓN
DN20 2 VÍAS CONEXIÓN 3/4" R/M**

REF.	EUROS	UNID. DE EMBALAJE	PESO UNID.
560081	363,03	1	3,000

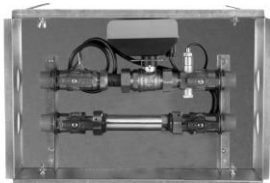

**KIT CALEFACCIÓN SERIE BS-K80 CON ARMARIO METÁLICO
DN 15 2 VÍAS CONEXIÓN 3/4" R/M**

REF.	EUROS	UNID. DE EMBALAJE	PESO UNID.
540080	453,12	1	5,000

**KIT CALEFACCIÓN SERIE BS-K80 CON ARMARIO METÁLICO
DN 20 2 VÍAS CONEXIÓN 3/4" R/M**

REF.	EUROS	UNID. DE EMBALAJE	PESO UNID.
540081	449,79	1	5,300

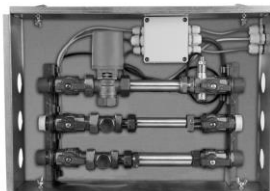

**MÓDULO DE USUARIO SERIE BS-K100VZ - 2 VIAS DN 15
CONEXIÓN 3/4" R/M**

REF.	EUROS	UNID. DE EMBALAJE	PESO UNID.
540100	526,38	1	17,500

**MÓDULO DE USUARIO SERIE BS-K100VZ - 2 VIAS DN 20
CONEXIÓN 3/4" R/M**

REF.	EUROS	UNID. DE EMBALAJE	PESO UNID.
540101	529,35	1	17,500

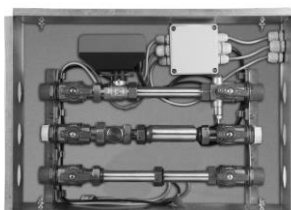

**MÓDULO DE USUARIO SERIE BS-K120SV - 2 VIAS DN 15
CONEXIÓN 3/4" R/M**

REF.	EUROS	UNID. DE EMBALAJE	PESO UNID.
540120	634,39	1	17,500

**MÓDULO DE USUARIO SERIE BS-K120SV - 2 VIAS DN 20
CONEXIÓN 3/4" R/M**

REF.	EUROS	UNID. DE EMBALAJE	PESO UNID.
540121	647,87	1	18,000

PARA INFORMACIÓN MÁS DETALLADA CONSULTAR EL CATALOGO TÉCNICO
MONTAJE ESTANDAR CON CONEXIÓN DE ENTRADA POR LA IZQUIERDA

Revisión B

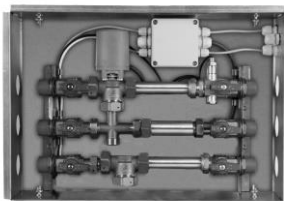
MÓDULOS COMPACTOS PARA LA CONTABILIZACIÓN DE LOS CONSUMOS TERMOSANITARIOS EQUIPADOS CON M-BUS Y ENTRADA DE IMPULSOS

**MÓDULO DE USUARIO SERIE BS-K220VZ – 3 VIAS SIN REGULACIÓN
DN15 CONEXIÓN ¾" R/M**

REF.	EUROS	UNID. DE EMBALAJE	PESO UNID.
540220	526,02	1	18,000

**MÓDULO DE USUARIO SERIE BS-K220VZ – 3 VIAS SIN REGULACIÓN
DN20 CONEXIÓN ¾" R/M**

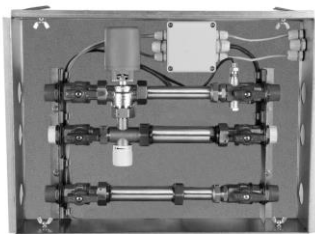
REF.	EUROS	UNID. DE EMBALAJE	PESO UNID.
540221	532,78	1	18,100

**MÓDULO DE USUARIO SERIE BS-K240VZ – 3 VIAS CON REGULACIÓN
DN15 CONEXIÓN ¾" R/M**

REF.	EUROS	UNID. DE EMBALAJE	PESO UNID.
540240	539,62	1	18,700

**MÓDULO DE USUARIO SERIE BS-K240VZ – 3 VIAS CON REGULACIÓN
DN20 CONEXIÓN ¾" R/M**

REF.	EUROS	UNID. DE EMBALAJE	PESO UNID.
540241	535,50	1	19,000

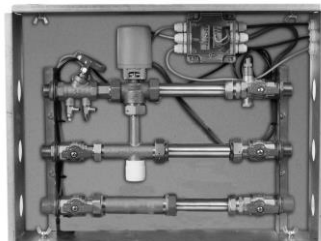
**MÓDULO DE USUARIO SERIE BS-K260VZ – 3 VIAS CON VÁLVULA DE
EQUILIBRADO Y BY-PASS REGULABLE DN15 CONEXIÓN ¾" R/M**

REF.	EUROS	UNID. DE EMBALAJE	PESO UNID.
540260	567,35	1	18,700

**MÓDULO DE USUARIO SERIE BS-K260VZ – 3 VIAS CON VÁLVULA DE
EQUILIBRADO Y BY-PASS REGULABLE DN20 CONEXIÓN ¾" R/M**

REF.	EUROS	UNID. DE EMBALAJE	PESO UNID.
540261	551,26	1	19,100

PARA INFORMACIÓN MÁS DETALLADA CONSULTAR EL CATALOGO TÉCNICO
MONTAJE ESTANDAR CON CONEXIÓN DE ENTRADA POR LA IZQUIERDA

**VÁLVULA TERMOSTÁTICA CAMPO DE REGULACIÓN: 30°-55°C PRECISIÓN ±2°
PRESIÓN DE EJERCICIO 10 BAR. MÁX. ESTÁTICA 5 BAR. DINÁMICA TEMPERATURA MÁX. DE ENTRADA
85° CAUDAL CON 3 BAR. 3000 L/H A 40°**



ROSCA GAS	REF.	EUROS	UNID. EMBALAJE	PESO UNID.
3/4" MACHO	990187	90,66	1	0,343
1" MACHO	990188	174,67	1	0,432

*Hasta fin de existencias

VÁLVULA DE ZONA 2 VIAS CONEXIÓN H-H 220 VS/24VS C.A.



ROSCA GAS	REF.	EUROS	UNID. EMBALAJE	PESO UNID.
1/2"	SF15-2BS	126,06	1	0,810
3/4"	SF20-2BS	127,50	1	0,980
1"	SF25-2BS	132,85	1	1,282

*Hasta fin de existencias

VÁLVULA DE ZONA 3 VIAS CONEXIÓN MACHO 220 VS



ROSCA GAS	REF.	EUROS	UNID. EMBALAJE	PESO UNID.
3/4"	SF20E2BS	129,06	1	1,100
1"	SF25E2BS	134,42	1	1,310

*Hasta fin de existencias

COLECTOR ABIERTO COMPONIBLE M-H CONEXIONES 1/2" M-Ø 12-14-15 y 16



COLECTOR/N° SALIDAS	REF.	EUROS	UNID. EMBALAJE	PESO UNID.
3/4" - 2	170025	6,19	10	0,150
3/4" - 3	170026	11,79	10	0,226
1" - 2	170028	9,67	10	0,235
1" - 3	170029	13,24	10	0,353
1" - 4	170030	16,11	10	0,416
1" - 5	170031	17,84	10	0,519

*Hasta fin de existencias

COLECTOR COMPONIBLE PARA A.C.S. CON VÁLVULAS 3/4" M-H CONEXIONES 1/2" M-Ø 12-14-15 y 16



N° SALIDAS	COLOR VOLANTE	REF.	EUROS	UNID. EMBALAJE	PESO UNID.
2	AZUL	170032	30,82	5	0,311
2	ROJO	170033	25,60	5	0,311
3	AZUL	170034	30,86	5	0,446
3	ROJO	170035	30,86	5	0,446
4	AZUL	170036	46,05	5	0,620
4	ROJO	170037	46,05	5	0,620

*Hasta fin de existencias

Revisión B

CONJUNTO RACOR Y BICONO

MEDIDA	REF.	EUROS	UNID. EMBALAJE	PESO UNID.
1/2" x 10	1040012	1,21	50	0,038
1/2" x 12	1040013	1,15	50	0,042
1/2" x 14	1040014	1,15	50	0,046
1/2" x 15	1040015	0,95	50	0,051
1/2" x 16	1040016	0,89	50	0,056

*Hasta fin de existencias

RACOR PARA TUBO MULTICAPA Y PLÁSTICO

MEDIDA	REF.	EUROS	UNID. EMBALAJE	PESO UNID.
1/2" x 14 x 10	1040017	1,79	50	0,039
1/2" x 16 x 12	1040018	1,71	50	0,045

*Hasta fin de existencias

CAJA DE PLÁSTICO PARA COLECTOR

MEDIDA	REF.	EUROS	UNID. EMBALAJE	PESO UNID.
32 x 26 x 9,5	530121	30,41	1	1,320

*Hasta fin de existencias

CAJA METÁLICA PARA EMPOTRAR

MEDIDA	REF.	EUROS	UNID. EMBALAJE	PESO UNID.
450 x 400	530124	111,04	1	3,500
450 x 600	530125	132,08	1	4,700
450 x 800	530126	158,65	1	6,500
450 x 1000	530127	253,97	1	8,400

*Hasta fin de existencias

SOPORTE METÁLICO MULTIDIÁMETRO PARA COLECTORES



MEDIDA	REF.	EUROS	UNID. EMBALAJE	PESO UNID.
3/4"-1"-1 1/4"	539904	7,84	2	0,310

*Hasta fin de existencias

Revisión B

ACCESORIOS

CONJUNTO SENSOR DE TEMPERATURA

	Ø SENSOR	LONG. SENSOR	REF.	EUROS	UNID. EMBALAJE	PESO UNID.
	5,0 mm	45 mm	SS3-106	68,54	2	0,064
	5,2 mm	105 mm	SM3-107	75,16	2	0,088
HASTA FIN DE EXISTENCIAS	6,0 mm	140 mm	SL3-108	114,89	2	0,104

PORTASONDAS PARA CONTADOR DN15 Y DN20

	ROSCA GAS	LONGITUD	REF.	EUROS	UNID. EMBALAJE	PESO UNID.
	G-1/2" x M-10	40 mm	EGM1520	5,92	2	0,070

PORTASONDAS PARA SENSOR DE TEMPERATURA

	ROSCA GAS	LONGITUD	REF.	EUROS	UNID. EMBALAJE	PESO UNID.
	G-1/2"	85 mm	PM-110	67,93	2	0,113
	G-1/4"	35 mm	PS-109	20,32	2	0,117

VÁLVULA PORTASONDAS

	ROSCA GAS	REF.	EUROS	UNID. EMBALAJE	PESO UNID.
	3/4" x M10	99000037	12,48	50	0,270

VÁLVULA DE EQUILIBRADO REGULACIÓN MICROMÉTRICA

	ROSCA GAS	REF.	EUROS	UNID. EMBALAJE	PESO UNID.
	3/4" H-H	990189	13,98	5	0,316
	1" H-H	990190	20,40	5	0,457

*Hasta fin de existencias

LLAVE DE TARADO REGULACIÓN MICROMÉTRICA

	REF.	EUROS	UNID. EMBALAJE	PESO UNID.
	990191	40,27	1	0,130

*Hasta fin de existencias

Revisión B

**CONVERTIDORES DE SEÑAL
ENTRADA IMPULSOS SALIDA M-BUS**

PAD PULS M 1 (PARA 1 CONTADOR)

	REF.	EUROS	UNID. EMBALAJE	PESO UNID.
	IM001G	129,90	1	0,050

PAD PULS M 2 (PARA 2 CONTADORES)

	REF.	EUROS	UNID. EMBALAJE	PESO UNID.
	IM003G	135,32	1	0,065

PAD PULS M 4 (PARA 4 CONTADORES)

	REF.	EUROS	UNID. EMBALAJE	PESO UNID.
	IM002GC	257,10	1	0,150

M-BUS MICRO-MASTER MÓDULO DE CONFIGURACIÓN (PARA MÁXIMO 10 CONTADORES)

	REF.	EUROS	UNID. EMBALAJE	PESO UNID.
	MR003USB	430,30	1	0,098

Revisión B

CENTRALITAS

M-BUS MASTER FAMILY C20



REF.	EUROS	UNID. EMBALAJE	PESO UNID.
20MR006DL	1.181,39	1	0,220

M-BUS MASTER FAMILY W60



REF.	EUROS	UNID. EMBALAJE	PESO UNID.
60MR004DL	1.516,40	1	0,310

Revisión B

M-BUS CENTRAL UNIT 120/250



REF.	EUROS	UNID. EMBALAJE	PESO UNID.
250DR001	3.401,51	1	1,200
120DR002	3.112,01	1	1,380

MODEM TERMINAL GSM SINTEON MC52IT+ANTENA



REF.	EUROS	UNID. EMBALAJE	PESO UNID.
MOD00005	671,14	1	0,294

ACCESORIOS PARA OBRA CIVIL Y RIEGO

Revisión B

23/01



Revisión B

ÍNDICE

PAG. 119-120.....	VÁLVULAS COMPUERTA Y FILTROS
PAG. 121.....	VÁLVULAS RETENCIÓN PORTABRIDAS PVC Y BRIDAS PARA PORTABRIDAS
PAG. 122.....	BRIDAS PLANAS SOLDAR Y ROSCADAS
PAG. 123.....	BRIDAS DOBLE CÁMARA Y UNIÓN UNIVERSAL CON BRIDA
PAG. 124.....	BRIDAS REDUCTORAS
PAG. 125-126.....	UNIÓNES GIBAULT – MULTIMEDIDA
PAG. 127.....	BRIDAS MULTIMEDIDA - ANTITRACCIÓN
PAG. 128-129.....	COLLARINES
PAG. 130.....	CABEZAL ROSCADO Y BANDA DE ACERO INOXIDABLE
PAG. 131-135.....	CABEZAL BRIDA Y UNIÓN ARPOL EN ACERO INOXIDABLE
PAG. 136-137.....	ABRAZADERAS DE REPARACIÓN
PAG. 138.....	VENTOSAS

ACCESORIOS PARA OBRA CIVIL Y RIEGO
VÁLVULA DE COMPUERTA DE CIERRE ELÁSTICO TIPO BRIDA (GGG-50)

DN	REF.	EUROS	UNID. EMBALAJE	PESO UNID.
50	200401	102,34	1	10,000
60	200402	120,40	1	13,000
80	200403	147,49	1	21,000
100	200404	183,61	1	23,000
125	200405	258,86	1	31,000
150	200406	307,02	1	42,000
200	200407	481,60	1	67,000

LAS VÁLVULAS DE COMPUERTA SE SIRVEN CON VOLANTE. PARA VÁLVULAS CON CUADRADILLO ESPECIFICAR EN PEDIDO

VÁLVULA COMPUERTA CIERRE ELÁSTICO CONEXIÓN PARA PVC CON VOLANTE (GGG-40)

DN	REF.	EUROS	UNID. EMBALAJE	PESO UNID.
50	200201	146,29	1	9,500
65	200202	190,98	1	12,000
80	200203	232,97	1	15,000
100	200204	306,12	1	19,000
125	200205	468,66	1	25,000
150	200206	490,33	1	34,000
200	200207	736,85	1	55,000
250	200208	1.221,76	1	86,000
300	200209	2.255,24	1	120,000

LAS VÁLVULAS DE COMPUERTA SE SIRVEN CON VOLANTE. PARA VÁLVULAS CON CUADRADILLO ESPECIFICAR EN PEDIDO

VÁLVULA DE REGISTRO ROSCA HEMBRA (GGG-40)

DN	REF.	EUROS	UNID. EMBALAJE	PESO UNID.
20	200561	107,01	1	3,000
25	200562	109,71	1	3,000
32	200563	124,61	1	4,000
40	200564	154,41	1	5,000
50	200565	190,98	1	6,000

Revisión B

ACCESORIOS PARA OBRA CIVIL Y RIEGO

VÁLVULA DE MARIPOSA EN ACERO INOXIDABLE TIPO WAFER



DN	REF.	EUROS	UNID. EMBALAJE	PESO UNID.
50	200361	54,33	1	4,000
65	200362	62,40	1	5,000
80	200363	69,47	1	6,000
100	200364	99,78	1	7,300
125	200365	144,60	1	11,000
150	200366	189,30	1	12,000
200	200367	302,23	1	13,000
250	200368	456,83	1	34,000
300	200369	706,66	1	46,000

VÁLVULA DE MARIPOSA TIPO WAFER



DN	REF.	EUROS	UNID. EMBALAJE	PESO UNID.
50 - 2"	200461	47,77	1	4,000
65 - 2 1/2"	200462	55,96	1	5,000
80 - 3"	200463	60,62	1	6,000
100 - 4"	200464	82,93	1	7,300
125 - 5"	200465	112,78	1	11,000
150 - 6"	200466	142,73	1	12,000
200 - 8"	200467	196,22	1	13,000

FILTRO DE FUNDICIÓN CON BRIDAS (GGG-40)



DN	REF.	EUROS	UNID. EMBALAJE	PESO UNID.
50	220104	88,04	1	8,500
65	220105	120,55	1	12,000
80	220106	138,16	1	15,000
100	220107	180,15	1	22,000
125	220108	280,38	1	34,000
150	220109	369,78	1	45,000
200	220110	617,65	1	75,000

Revisión B

ACCESORIOS PARA OBRA CIVIL Y RIEGO

VÁLVULA RETENCIÓN DOBLE CLAPETA



DN	REF.	EUROS	UNID. EMBALAJE	PESO UNID.
50	210401	48,16	1	1,600
65	210402	65,02	1	2,200
80	210403	79,92	1	3,500
100	210404	91,05	1	4,700
125	210405	134,10	1	6,500
150	210406	173,53	1	8,000
200	210407	294,68	1	14,000

MANGUITO PORTABRIDAS PVC



DN	REF.	EUROS	UNID. EMBALAJE	PESO UNID.
50	2000001	0,99	1	0,140
63	2000002	2,83	1	0,165
75	2000003	3,88	1	0,205
90	2000004	4,98	1	0,298
110	2000005	9,09	1	0,387
125	2000006	12,13	1	0,416
140	2000007	15,14	1	0,596
160	2000008	20,33	1	0,832
200	2000009	36,10	1	1,310
250	2000010	52,99	1	1,600

Revisión B

BRIDA PLANA PORTABRIDAS PN10-16



DN	REF.	EUROS	UNID. EMBALAJE	PESO UNID.
63	2100001	13,48	1	2,000
75	2100002	14,55	1	2,000
90	2100003	14,36	1	2,270
110	2100004	16,04	1	2,410
125	2100005	21,52	1	2,970
160	2100007	24,98	1	3,580
200	2100008	38,05	1	5,430

BRIDAS PN10/16

BRIDA PLANA PARA SOLDAR PN-10/16 – DIN-2576



DN	PN	PULGADAS	REF.	EUROS	UNID. EMBALAJE	PESO UNID.
32	10	1 1/4"	1010701	12,17	1	1,870
40	10	1 1/2"	1010702	13,64	1	2,200
50	10	2"	1010703	15,15	1	2,820
65	10	2 1/2"	1010704	17,54	1	3,450
80	10	3"	1010705	19,98	1	4,210
100	16	4"	1010706	27,28	1	4,650
125	16	5"	1010707	28,56	1	5,970
150	16	6"	1010708	39,98	1	6,980

BRIDA PLANA ROSCADA PN-10/16 – DIN-2576 ZINCADA



DN	PN	PULGADAS	REF.	EUROS	UNID. EMBALAJE	PESO UNID.
32	10	1 1/4"	1010801	11,94	1	1,870
40	10	1 1/2"	1010802	13,56	1	2,200
50	10	2"	1010803	13,35	1	2,820
65	10	2 1/2"	1010804	15,97	1	3,450
80	10	3"	1010805	20,16	1	4,210
100	16	4"	1010806	35,31	1	4,650

BRIDAS PN6

BRIDA PLANA PARA PORTABRIDAS PN-6 – DIN-2573 ZINCADA



DN	PN	PULGADAS	REF.	EUROS	UNID. EMBALAJE	PESO UNID.
50	6	2"	10040815	9,23	1	1,221
65	6	2 1/2"	10040813	11,16	1	1,477
80	6	3"	10040814	18,26	1	2,534

CONSULTAR DISPONIBILIDAD

BRIDA PLANA ROSCADA PN-6 – DIN-2573 ZINCADA



DN	PN	PULGADAS	REF.	EUROS	UNID. EMBALAJE	PESO UNID.
50	6	2"	10031113	12,28	1	1,509
65	6	2 1/2"	10031114	15,60	1	1,965
80	6	3"	10031115	23,02	1	3,047

CONSULTAR DISPONIBILIDAD

Revisión B

ACCESORIOS PARA OBRA CIVIL Y RIEGO
BRIDA DOBLE CÁMARA P-E CON CIERRE DE METAL

TUBO Ø	BRIDA DN	REF.	EUROS	UNID. EMBALAJE	PESO UNID.
63	50 - 2"	1011101	44,70	1	2,800
75	65 - 2 1/2"	1011102	48,76	1	2,950
90	80 - 3"	1011103	56,89	1	3,600
110	100 - 4"	1011104	70,43	1	4,300
125	125 - 5"	1011105	88,04	1	5,500
160	150 - 6"	1011107	128,68	1	7,300
200	200 - 8"	1011109	243,81	1	12,000

BRIDA DOBLE CÁMARA PVC

TUBO Ø	BRIDA DN	REF.	EUROS	UNID. EMBALAJE	PESO UNID.
63	65 - 2 1/2"	1011001	28,44	1	2,800
75	65 - 2 1/2"	1011002	32,51	1	2,950
90	80 - 3"	1011003	36,57	1	3,600
110	100 - 4"	1011004	43,34	1	4,300
125	125 - 5"	1011005	58,70	1	5,500
140	125 - 5"	1011006	66,37	1	5,500
160	150 - 6"	1011007	82,62	1	7,300
200	200 - 8"	1011009	140,87	1	12,000

UNIÓN UNIVERSAL CON BRIDA

TUBO Ø	MÍN.	MÁX.	REF.	EUROS	UNID. EMBALAJE	PESO UNID.
65	72	85	290101	73,14	1	4,500
80	88	103	290102	85,33	1	4,900
100	108	128	290103	94,82	1	5,500
125	132	154	290104	131,39	1	7,800
150	159	182	290105	143,58	1	8,300
200	218	238	290107	185,57	1	11,300

Revisión B

ACCESORIOS PARA OBRA CIVIL Y RIEGO

BRIDA REDUCTORA



DN	REF.	EUROS	UNID. EMBALAJE	PESO UNID.
080-050	1010901	52,34	1	3,790
080-060	1010902	53,57	1	3,500
100-050	1010903	58,41	1	4,330
100-060	1010904	60,56	1	4,000
100-080	1010905	79,42	1	4,500
125-060	1010907	65,07	1	5,460
125-080	1010908	79,23	1	5,700
125-100	1010909	78,25	1	5,800
150-060	1010911	74,97	1	6,570
150-080	1010912	90,93	1	6,500
150-100	1010913	91,78	1	6,500
200-100	1010916	119,69	1	9,600
200-150	1010918	118,77	1	9,650
250-100	1010921	214,76	1	12,600
250-150	1010923	187,39	1	12,900
250-200	1010924	207,96	1	13,100

Revisión B

ACCESORIOS PARA OBRA CIVIL Y RIEGO

UNIÓN GIBALT PARA PVC CON TORNILLO ACERO ZINCADO



DN	LONGITUD	REF.	EUROS	UNID. EMBALAJE	PESO UNID.
63	105	340001	16,13	1	1,250
75	104	340002	18,87	1	2,000
90	116	340003	22,64	1	2,900
110	109	340004	31,54	1	4,000
125	114	340005	36,33	1	4,800
140	135	340006	45,48	1	5,000
160	156	340007	55,20	1	6,000
180	158	340008	69,20	1	8,000
200	158	340009	95,75	1	10,000

UNIÓN MULTIMEDIDA PN16 CON TOLERANCIA



DN	TOLERANCIA Mín. - Máx.	REF.	EUROS	UNID. EMBALAJE	PESO UNID.
65	68-85	360001	69,08	1	4,500
80	84-106	360002	88,04	1	5,000
100	109-133	360003	107,01	1	5,700
125	132-157	360004	146,29	1	7,500
150	157-183	360005	149,00	1	8,900
175	193-215	360006	182,86	1	9,700
200	218-242	360007	211,30	1	10,000

UNIÓN DE TRANSICIÓN AUTOBLOCANTE UNIVERSAL



TOLERANCIA	REF.	EUROS	UNID. EMBALAJE	PESO UNID.
57-74/63	310001	224,85	1	4,980
68-85/75	310002	235,68	1	5,730
84-106/90	310003	272,25	1	7,380
99-119/90	310004	323,73	1	8,050
99-119/110	310005	342,69	1	8,620
109-133/110	310006	357,59	1	9,690
109-133/125	310007	391,45	1	9,750
132-157/125	310008	423,96	1	11,490
132-157/140	310009	441,57	1	11,560
157-183/160	310010	491,68	1	13,690
193-215/200	310011	639,32	1	17,890
218-242/200	310012	679,96	1	20,250

Revisión B

ACCESORIOS PARA OBRA CIVIL Y RIEGO
UNIÓN MULTIMEDIDA PN16

Ø	REF.	EUROS	UNID. EMBALAJE	PESO UNID.
61-94	370001	216,72	1	11,000
81-114	370002	268,19	1	14,300
106-164	370003	292,57	1	15,590
131-164	370004	371,13	1	20,000
156-194	370005	419,90	1	23,480
191-229	370006	472,72	1	27,420
216-257	370007	558,05	1	31,560
241-279	370008	651,51	1	35,090
236-274	370009	632,55	1	35,500
271-309	370010	656,93	1	38,960
311-351	370011	755,81	1	42,340
349-389	370012	781,55	1	44,630
396-434	370013	1.078,18	1	48,440
436-469	370014	1.216,34	1	53,600
471-504	370015	1.339,60	1	59,080
506-539	370016	1.740,53	1	64,200

Revisión B

UNIÓN MULTIMEDIDA GRAN TOLERANCIA PN16

Ø	REF.	EUROS	UNID. EMBALAJE	PESO UNID.
156-194	390001	528,26	1	22,200
191-229	390002	662,35	1	28,800
216-257	390003	734,14	1	32,900
311-349	390004	869,59	1	37,600
351-389	390005	1.217,70	1	42,000
396-434	390006	1.213,63	1	45,300
396-434	390007	1.270,52	1	49,500
396-434	390008	1.502,14	1	56,200
471-504	390009	1.481,82	1	58,000
471-504	390010	1.605,08	1	63,000
506-539	390011	1.745,95	1	65,600
576-609	390012	1.924,74	1	71,000

ACCESORIOS PARA OBRA CIVIL Y RIEGO
BRIDA MULTIMEDIDA

DN	REF.	EUROS	UNID. EMBALAJE	PESO UNID.
300	350001	931,90	1	36,000
300	350002	1.022,65	1	36,000
350	350003	1.061,93	1	39,000
400	350004	1.309,80	1	54,000
400	350005	1.424,93	1	57,000
500	350006	1.744,60	1	75,000
500	350007	1.859,73	1	73,000
500	350008	2.173,97	1	83,500

UNIÓN ANTITRACCIÓN PARA PVC Y PE

DN	REF.	EUROS	UNID. EMBALAJE	PESO UNID.
50	330001	97,52	1	2,500
63	330002	101,59	1	2,900
75	330003	108,36	1	3,400
90	330004	123,26	1	4,000
110	330005	153,06	1	5,400
125	330006	209,95	1	6,850
140	330007	228,91	1	8,000
160	330008	251,94	1	8,600
200	330009	348,11	1	12,700
250	330010	707,05	1	24,800
315	330011	995,56	1	32,000
400	330012	1.395,14	1	40,000

Revisión B

BRIDA ANTITRACCIÓN PARA PVC Y PE

DN	REF.	EUROS	UNID. EMBALAJE	PESO UNID.
50/63	320001	89,40	1	3,760
65/75	320002	97,52	1	4,120
80/90	320003	107,01	1	4,420
100/110	320004	127,32	1	6,000
125/125	320005	180,15	1	7,200
125/140	320006	182,86	1	7,940
150/160	320007	207,24	1	8,900
200/200 PN10	320008	293,93	1	12,300
200/200 PN16	320009	293,93	1	12,300
250	320010	572,95	1	24,500
315	320011	696,21	1	29,000
400/400	320012	1.002,33	1	45,000

ACCESORIOS PARA OBRA CIVIL Y RIEGO

COLLARÍN DE TOMA TIPO ABRAZADERA PARA TUBO P-E Y PVC

Revisión B



DN	ROSCA GAS.	REF.	EUROS	UNID. EMBALAJE	PESO UNID.
50	3/4"	290001-3/4"	21,58	1	1,710
50	1"	290001-1"	21,58	1	1,710
63	3/4"	290002-3/4"	25,43	1	2,300
63	1"	290002-1"	25,43	1	2,300
75	3/4"	290003-3/4"	28,29	1	2,900
75	1"	290003-1"	28,29	1	2,900
75	1 1/4"	290003-1 1/4"	28,96	1	2,900
90	3/4"	290004-3/4"	32,00	1	4,250
90	1"	290004-1"	32,00	1	4,250
90	1 1/4"	290004-1 1/4"	32,51	1	4,250
90	1 1/2"	290004-1 1/2"	32,69	1	4,250
90	2"	290004-2"	35,61	1	4,250
110	3/4"	290005-3/4"	39,13	1	5,100
110	1"	290005-1"	39,13	1	5,100
110	1 1/4"	290005-1 1/4"	39,37	1	5,100
110	1 1/2"	290005-1 1/2"	39,70	1	5,100
110	2"	290005-2"	42,71	1	5,100
125	3/4"	290006-3/4"	45,21	1	6,200
125	1"	290006-1"	45,21	1	6,200
125	1 1/4"	290006-1 1/4"	46,23	1	6,200
125	1 1/2"	290006-1 1/2"	46,41	1	6,200
125	2"	290006-2"	48,37	1	6,200
140	1"	290007-1"	61,22	1	7,050
140	1 1/4"	290007-1 1/4"	63,42	1	7,050
140	1 1/2"	290007-1 1/2"	63,87	1	7,050
140	2"	290007-2"	66,46	1	7,050
160	1"	290008-1"	73,99	1	8,150
160	1 1/4"	290008-1 1/4"	74,92	1	8,150
160	1 1/2"	290008-1 1/2"	75,37	1	8,150
160	2"	290008-2"	76,27	1	8,150

ACCESORIOS PARA OBRA CIVIL Y RIEGO
COLLARÍN FUNDICIÓN SALIDA BRIDA

MEDIDA	REF.	EUROS	UNID. EMBALAJE	PESO UNID.
110/50-65	270001	109,99	1	3,600
110/80	270002	129,10	1	4,300
125/50-65	270003	140,18	1	4,900
125/80	270004	164,53	1	6,300
140/50-65	270005	159,92	1	6,800
140/80-100	270006	178,16	1	7,600
160/50-65	270007	174,52	1	7,400
160/80-100	270008	186,92	1	8,800
200/50-65	270009	202,42	1	8,800
200/80-100	270010	217,11	1	10,000
200/125-150	270011	291,61	1	13,500
250/50-65	270012	267,47	1	11,500
250/80-100	270013	288,69	1	12,800
250/125-150	270014	370,50	1	17,500
315/50-65	270015	477,72	1	22,500
315/80-100	270016	546,62	1	23,500
315/125-150	270017	652,36	1	31,500
355/80-100	270018	509,53	1	21,000
355/125-150	270019	689,71	1	26,000
355/200 PN16	270020	757,83	1	27,000
400/80-100	270021	593,93	1	26,500
400/125-150	270022	772,82	1	36,200
400/200 PN16	270023	854,33	1	40,000
500/80-100	270024	819,47	1	39,000
500/125-150	270025	966,87	1	40,000
500/200 PN16	270026	1.120,86	1	42,000

Revisión B

ACCESORIOS PARA OBRA CIVIL Y RIEGO
CABEZAL ROSCADO UNIVERSAL

TUBERÍA	REF.	EUROS	UNID. EMBALAJE	PESO UNID.
3/4"	300001	29,80	1	1,250
1"	300002	29,80	1	1,250
1 1/4"	300003	35,22	1	1,820
1 1/2"	300004	35,22	1	1,810
2"	300005	35,22	1	1,810
2 1/2"	300006	111,07	1	2,000
3"	300007	149,00	1	2,300

BANDA DE ACERO INOXIDABLE PARA CABEZAL ROSCADO UNIVERSAL

Ø	REF.	EUROS	UNID. EMBALAJE	PESO UNID.
55-89	300201	40,64	1	0,600
89-119	300202	43,34	1	0,650
106-134	300203	44,70	1	0,680
134-160	300204	46,05	1	0,700
157-187	300205	47,41	1	0,720
187-217	300206	51,47	1	0,750
211-245	300207	52,83	1	0,800
241-271	300208	55,53	1	0,850
266-299	300209	56,89	1	0,900
300-331	300210	59,60	1	0,950
316-346	300211	62,31	1	1,000
326-360	300212	63,66	1	1,000
399-435	300213	102,94	1	1,350
451-485	300214	105,65	1	1,440
499-535	300215	107,01	1	1,550
561-595	300216	108,36	1	1,670
621-655	300217	111,07	1	1,750
676-710	300218	128,68	1	1,860

Revisión B

ACCESORIOS PARA OBRA CIVIL Y RIEGO

CABEZAL BRIDA



DN	REF.	EUROS	UNID. EMBALAJE	PESO UNID.
50	300101	111,07	1	5,200
60-65	300102	135,45	1	6,500
80	300103	178,79	1	8,500
100	300104	234,33	1	11,300
125	300105	297,99	1	16,300
150	300106	763,94	1	18,400
200 PN10	300107	999,62	1	35,000
200 PN16	300108	999,62	1	35,000

UNIÓN ARPOL EN ACERO INOXIDABLE PARA CONEXIONES A POLIETILENO



DN	REF.	EUROS	UNID. EMBALAJE	PESO UNID.
63	290201	258,52	1	0,900
75	290202	290,84	1	1,400
90	290203	313,32	1	1,600
110	290204	342,82	1	1,700
125	290205	393,40	1	2,500
140	290206	463,65	1	2,650
160	290207	497,37	1	2,900
180	290208	883,75	1	7,700
200	290209	955,40	1	8,200
250	290210	1.079,04	1	9,400
315	290211	1.295,41	1	12,500
400	290212	1.680,38	1	18,700

Revisión B

ACCESORIOS PARA OBRA CIVIL Y RIEGO
**UNIÓN ARPOL EN ACERO INOXIDABLE
PARA TUBERÍAS DE VARIOS MATERIALES**
ANCHO DE UNIÓN 90 mm

Ø	REF.	EUROS	UNID. EMBALAJE	PESO UNID.
74-78	290401	221,99	1	1,590
80-86	290402	226,21	1	1,640
87-93	290403	229,02	1	1,680
98-106	290404	236,04	1	1,810
107-111	290405	237,45	1	1,840
110-116	290406	244,47	1	1,890
118-125	290407	247,28	1	1,970
125-131	290408	247,28	1	1,970
131-136	290409	251,50	1	2,010
137-144	290410	254,31	1	2,050
147-156	290411	261,33	1	2,180
156-162	290412	262,74	1	2,200

Revisión B

ACCESORIOS PARA OBRA CIVIL Y RIEGO

UNIÓN ARPOL EN ACERO INOXIDABLE
PARA TUBERÍAS DE VARIOS MATERIALES

ANCHO DE UNIÓN 140 mm



Ø	REF.	EUROS	UNID. EMBALAJE	PESO UNID.
166-178	290501	525,47	1	7,660
173-185	290502	525,47	1	7,660
186-198	290503	525,47	1	7,660
194-206	290504	525,47	1	7,660
202-214	290505	564,81	1	8,350
217-229	290506	564,81	1	8,350
231-243	290507	564,81	1	8,350
248-260	290508	564,81	1	8,350
271-283	290509	602,75	1	9,050
279-291	290510	602,75	1	9,050
292-304	290511	602,75	1	9,050
310-322	290512	643,49	1	9,740
320-332	290513	643,49	1	9,740
320-341	290514	643,49	1	9,740
338-350	290515	643,49	1	9,740
349-361	290516	643,49	1	9,740
359-371	290517	681,43	1	10,440
372-384	290518	681,43	1	10,440
379-391	290519	681,43	1	10,440
394-406	290520	681,43	1	10,440
403-415	290521	925,90	1	11,130
410-422	290522	925,90	1	11,130
419-431	290523	925,90	1	11,130
425-437	290524	925,90	1	17,260
433-445	290525	925,90	1	17,260
450-462	290526	973,67	1	18,430
467-479	290527	973,67	1	18,430
477-489	290528	973,67	1	18,430
487-499	290529	973,67	1	18,430
493-505	290530	973,67	1	23,180
504-520	290531	1.142,27	1	23,180
525-541	290532	1.142,27	1	23,180
539-555	290533	1.142,27	1	23,180
557-573	290534	1.197,06	1	23,180
583-599	290535	1.197,06	1	23,180
599-615	290536	1.197,06	1	23,180
614-630	290537	1.240,62	1	22,650
630-646	290538	1.240,62	1	22,650
650-666	290539	939,95	1	22,650
676-692	290540	939,95	1	22,650
706-722	290541	1.357,23	1	22,650
719-735	290542	1.357,23	1	22,650

Revisión B

ACCESORIOS PARA OBRA CIVIL Y RIEGO

UNIÓN ARPOL EN ACERO INOXIDABLE
PARA TUBERÍAS DE VARIOS MATERIALES

ANCHO DE UNIÓN 200 mm

Revisión B



Ø	REF.	EUROS	UNID. EMBALAJE	PESO UNID.
150-160	290607	525,47	1	7,660
166-178	290608	525,47	1	7,660
173-185	290609	525,47	1	7,660
186-198	290610	525,47	1	7,660
194-206	290611	525,47	1	7,660
202-214	290612	564,81	1	8,350
217-229	290613	564,81	1	8,350
231-243	290614	564,81	1	8,350
242-254	290615	564,81	1	8,350
248-260	290616	564,81	1	8,350
271-283	290617	602,75	1	9,050
279-291	290618	602,75	1	9,050
292-304	290619	602,75	1	9,050
310-322	290620	643,49	1	9,740
320-332	290621	643,49	1	9,740
329-341	290622	643,49	1	9,740
338-350	290623	643,49	1	9,740
349-361	290624	643,49	1	9,740
359-371	290625	681,43	1	13,210
372-384	290626	681,43	1	13,210
379-391	290627	681,43	1	13,210
394-406	290628	681,43	1	13,210
403-415	290629	720,77	1	14,080
410-422	290630	925,90	1	14,080
419-431	290631	925,90	1	14,080
425-437	290632	925,90	1	14,080
433-445	290633	925,90	1	14,080
450-462	290634	1.035,49	1	15,970
467-479	290635	1.035,49	1	15,970
477-489	290636	1.035,49	1	15,970
487-499	290637	1.035,49	1	15,970
493-505	290638	1.035,49	1	15,970
504-520	290639	1.140,86	1	16,100
525-541	290640	1.140,86	1	16,100
539-555	290641	1.140,86	1	16,100

ACCESORIOS PARA OBRA CIVIL Y RIEGO

UNIÓN ARPOL EN ACERO INOXIDABLE
PARA TUBERÍAS DE VARIOS MATERIALES

ANCHO DE UNIÓN 200 mm



Ø	REF.	EUROS	UNID. EMBALAJE	PESO UNID.
548-564	290642	1.140,86	1	16,890
557-573	290643	1.195,66	1	21,470
583-599	290644	1.195,66	1	21,470
599-615	290645	1.195,66	1	21,470
614-630	290646	1.250,45	1	21,470
630-646	290647	1.250,45	1	27,720
650-666	290648	1.250,45	1	27,720
676-692	290649	1.250,45	1	27,720
706-722	290650	1.360,04	1	27,720
719-735	290651	1.270,12	1	40,740
734-750	290652	1.413,43	1	40,740
744-760	290653	1.471,04	1	40,740
757-773	290654	1.986,67	1	40,740
767-783	290655	1.986,67	1	40,740
788-804	290656	1.986,67	1	40,740
808-824	290657	2.059,73	1	44,380
820-836	290658	2.059,73	1	44,380
837-853	290659	2.059,73	1	44,380
851-867	290660	2.132,79	1	44,380
866-882	290661	2.132,79	1	44,380
877-893	290662	2.132,79	1	44,380
900-916	290663	2.205,85	1	46,200
908-924	290664	2.205,85	1	46,200
921-937	290665	2.205,85	1	46,200
938-954	290666	2.205,85	1	46,200
957-973	290667	2.281,72	1	46,200
976-992	290668	2.281,72	1	46,200
987-1003	290669	2.281,72	1	46,200
1010-1026	290670	2.346,35	1	51,660
1042-1058	290671	2.346,35	1	51,660
1055-1071	290672	2.440,49	1	51,660
1078-1094	290673	2.440,49	1	51,660
1084-1100	290674	2.440,49	1	51,660
1097-1113	290675	2.440,49	1	51,660
1112-1128	290676	2.534,62	1	55,310
1124-1140	290677	2.534,62	1	55,310
1148-1164	290678	2.534,62	1	55,310
1172-1188	290679	2.632,97	1	55,310
1193-1209	290680	2.632,97	1	55,310
1208-1224	290681	2.734,13	1	55,310

Revisión B

ACCESORIOS PARA OBRA CIVIL Y RIEGO

ABRAZADERA DE REPARACIÓN 2 CIERRES

Revisión B



Ø	REF.	EUROS	UNID. EMBALAJE	PESO UNID.
140-160	380201	256,00	1	3,500
159-180	380202	260,06	1	3,600
165-185	380203	264,13	1	3,600
168-189	380204	268,19	1	3,650
170-190	380205	269,55	1	3,650
176-196	380206	270,90	1	3,700
190-210	380207	280,38	1	3,760
195-217	380208	288,51	1	3,760
210-230	380209	292,57	1	4,000
216-238	380210	310,18	1	4,000
225-246	380211	325,08	1	4,300
230-250	380212	327,79	1	4,350
240-260	380213	327,49	1	4,400
250-270	380214	332,30	1	4,550
269-289	380215	337,27	1	4,650
273-293	380216	338,63	1	4,650
282-302	380217	342,69	1	4,800
295-315	380218	346,75	1	4,800
299-330	380219	348,11	1	4,800
315-335	380220	348,11	1	4,950
322-344	380221	352,17	1	5,000
337-358	380222	354,88	1	5,200
347-367	380223	360,30	1	5,300
365-385	380224	364,36	1	5,400
382-402	380225	383,32	1	5,000
396-420	380226	387,39	1	5,500
410-430	380227	390,10	1	5,850
420-440	380228	391,45	1	5,900
435-455	380229	394,16	1	5,950

ACCESORIOS PARA OBRA CIVIL Y RIEGO
ABRAZADERA DE REPARACIÓN 1 CIERRE

Ø	REF.	EUROS	UNID. EMBALAJE	PESO UNID.
48-52	380101	100,23	1	1,000
54-58	380102	101,59	1	1,300
60-67	380103	104,30	1	1,350
67-74	380104	109,71	1	1,400
70-77	380105	116,49	1	1,450
73-80	380106	116,49	1	1,500
76-83	380107	116,49	1	1,500
82-89	380108	119,20	1	1,500
87-94	380109	119,20	1	1,500
91-98	380110	120,55	1	1,500
95-102	380111	123,26	1	1,500
98-108	380112	124,61	1	1,650
102-112	380113	125,97	1	1,650
106-116	380114	125,97	1	1,700
108-118	380115	127,32	1	1,700
113-123	380116	127,32	1	1,900
118-128	380117	130,03	1	1,900
120-131	380118	130,03	1	1,950
125-135	380119	131,39	1	1,950
132-142	380120	135,45	1	2,000
135-145	380121	139,51	1	2,000
145-155	380122	142,22	1	2,100
151-161	380123	149,00	1	2,100

Revisión B

ACCESORIOS PARA OBRA CIVIL Y RIEGO
VENTOSA AUTOMÁTICA FUNDICIÓN DOBLE EFECTO GGG40

DN	REF.	EUROS	UNID. EMBALAJE	PESO UNID.
50	670003	277,01	1	8,000
65	670008	336,24	1	10,000

VENTOSA AUTOMÁTICA FUNDICIÓN TRIPLE EFECTO GGG40

DN	REF.	EUROS	UNID. EMBALAJE	PESO UNID.
50	670103	400,71	1	9,000
65	670108	461,68	1	10,000

VENTOSA AUTOMÁTICA DE POLIAMIDA DOBLE EFECTO

DN	REF.	EUROS	UNID. EMBALAJE	PESO UNID.
32-1"	670009	20,91	1	0,300
60-2"	670010	36,59	1	0,800

VENTOSA AUTOMÁTICA DE POLIAMIDA TRIPLE EFECTO

DN	REF.	EUROS	UNID. EMBALAJE	PESO UNID.
32-1"	670011	52,27	1	0,400
60-2"	670012	95,82	1	0,900

Revisión B

CONDICIONES GENERALES DE VENTA

PRECIOS

La presente TARIFA anula y sustituye cualquier otro anterior. Así mismo, anula cualquier oferta personalizada anterior.

Las entregas de los pedidos se facturarán al precio en vigor en el momento del pedido.

Con el fin de evitar errores y poder tramitar correctamente, es importante que cada artículo esté acompañado de su correspondiente código identificativo, el cual está referenciado en esta misma tarifa.

ÁMBITO

Las presentes condiciones de venta se aplicarán a todos los pedidos. Cualquier variación deberá haber sido expresamente aceptada por **BATERÍAS DEL SURESTE, S.L.U.**, vía fax, correo electrónico o carta.

I.V.A.

No incluido. Se aplicará el tipo vigente.

ENTREGA

La cumplimentación de los pedidos se realizará dentro de los tres días hábiles siguientes a la recepción del pedido, siempre y cuando los artículos sean los incluidos en el siguiente catálogo.

El plazo de entrega se considera hasta el momento de entrega de la mercancía a la agencia de transporte.

Todo artículo especial tiene un plazo de entrega máximo de 21 días tras la confirmación por escrito del pedido, mediante plano acotado y detallado, sellado o firmado.

TRANSPORTE

Portes pagados a partir de 600 € netos de pedido. Para Península y Baleares.

Portes pagados a partir de 1.500 € netos de pedido. Para Canarias, Ceuta y Melilla.

Portes pagados a partir de 1.000 € netos de pedido. Para Portugal.

Las portes correspondientes a los envíos que soliciten URGENTES y que deban ser expedidos por otra Agencia de Transporte distinta a la que **BATERÍAS DEL SURESTE, S.L.U.** tiene contratada, correrán a cargo del consignatario.

Los pedidos por importe inferior al mínimo, se cargará el transporte en factura, descontando la parte proporcional al importe pedido en factura.

CONDICIONES DE PAGO

Todo impuesto aplicable en el momento de facturación del pedido será por parte del comprador.

El plazo máximo de pago será de 45 días fecha factura.

El descuento aplicable para operaciones de contado o recibo domiciliado hasta 7 días es del 2%.

Así mismo, el comprador reembolsará al vendedor, en concepto de daños y perjuicios, las cargas bancarias y judiciales, devengadas a causa del impago de efectos.

RECLAMACIONES Y DEVOLUCIONES

No se admitirán devoluciones ni reclamaciones transcurridos 15 días desde la fecha de recepción de la mercancía. En cualquier caso, las devoluciones de material deberán efectuarse en base a las siguientes normas:

- 1.- Toda devolución de mercancía deberá ser notificada previamente.
- 2.- Toda devolución aceptada deberá haber sido confirmada por escrito por parte de **BATERÍAS DEL SURESTE, S.L.U.**
- 3.- Toda devolución de material deberá ir acompañada de albarán del Sr. Cliente con especificación del material devuelto.
- 4.- En el albarán que acompaña la mercancía deberá reflejar claramente el Número de referencia de la aceptación por parte de **BATERÍAS DEL SURESTE, S.L.U.**
- 5.- En ningún caso se admitirán devoluciones de trabajos especiales que se ajusten a las características y planos solicitados por nuestros clientes.
- 6.- Toda mercancía devuelta debe venir a PORTES PAGADOS.
- 7.- En cualquier caso, no se admitirá mercancía que no se encuentre en perfecto estado. Se procederá a la devolución al cliente de dichos artículos.
- 8.- En caso de devolución por causas ajenas a **BATERÍAS DEL SURESTE, S.L.U.**, se realizará un cargo adicional del 2% en concepto de gastos de manipulación y gestión.
- 9.- Los abonos emitidos serán compensados con facturas posteriores.

En ningún caso **BATERÍAS DEL SURESTE, S.L.U.** se hará cargo de las devoluciones que no cumplan estas normas.

GARANTÍA

La garantía de nuestros productos está limitada a 3 años, fecha de factura o documento de entrega, según Real Decreto Legislativo 7/2021 de 27 de abril, por el que se aprueba el texto consolidado de la modificación de la Ley General para la Defensa de los Consumidores y Usuarios y otras leyes complementarias, en su Artículo IV de Garantías y servicios postventa, en su Capítulo III, Ejercicio de derechos por el consumidor y usuario, en su Artículo 120, Plazo para la manifestación de la falta de conformidad, Punto 1 (BOE núm. 101, de 28-04-2021, pp. A-202-6872), salvo que se exprese de forma explícita, lo contrario. Esta garantía puede sufrir variación, condicionada a futuras leyes o decretos.

BATERÍAS DEL SURESTE, S.L.U. garantiza todos los artículos de cualquier defecto de fabricación. Quedando limitada nuestra responsabilidad a la sustitución de la pieza defectuosa. Una vez que nuestro Departamento Técnico haya analizado y confirmado dicho defecto.

BATERÍAS DEL SURESTE, S.L.U. y el Cliente se someten para cualquier litigio a los Juzgados y Tribunales de Murcia.



DATOS GPS

Formato Decimal: 37.998479, -1.088079

Formato Grados: 37° 59' 54.5244" Latitud

-1° 5' 17.0844" Longitud

MOD.BS TP 01.05.23 (B)



Revisión B

23/01

